



## Instruction Manual

### NivuLink Compact

NLC0CLOG  
NLC0CLOGP  
NLC0CLOGS  
NLC0CS70  
NLC0CNF0



**Revised Instruction Manual**

Firmware Version: 17

Rev. 04 / 05.04.2022

Original Manual: German, rev 04 as of 05.04.2022

measure analyse optimise

**Nivus AG**

Burgstrasse 28  
8750 Glarus, Schweiz  
Phone: +41 55 6452066  
Fax: +41 55 6452014  
swiss@nivus.com  
www.nivus.de

**NIVUS Austria**

Mühlbergstraße 33B  
3382 Loosdorf, Österreich  
Phone: +43 2754 567 6321  
Fax: +43 2754 567 6320  
austria@nivus.com  
www.nivus.de

**NIVUS Sp. z o.o.**

ul. Hutnicza 3 / B-18  
81-212 Gdynia, Polen  
Phone: +48 58 7602015  
Fax: +48 58 7602014  
biuro@nivus.pl  
www.nivus.pl

**NIVUS France**

12 rue Principale  
67870 Bischofsheim, Frankreich  
Phone: +33 388 999284  
info@nivus.fr  
www.nivus.fr

**NIVUS Ltd., United Kingdom**

Wedgewood Rugby Road  
Weston under Wetherley  
Royal Leamington Spa  
CV33 9BW, Warwickshire  
Phone: +44 1926 632470  
nivusUK@nivus.com  
www.nivus.com

**NIVUS Middle East (FZE)**

Building Q 1-1 ap. 055  
P.O. Box: 9217  
Sharjah Airport International  
Free Zone  
Tel.: +971 6 557 8224  
Fax: +971 6 557 8225  
middle-east@nivus.com  
www.nivus.com

**NIVUS Korea Co. Ltd.**

#2502 M Dong, Technopark IT Center,  
32 Song-do-gwa-hak-ro, Yeon-su-gu,  
INCHEON, Korea 21984  
Tel.: +82 32 209 8588  
Fax: +82 32 209 8590  
korea@nivus.com  
www.nivus.com

**NIVUS Vietnam**

238/78 Phan Trung Street,  
Tan Tien Ward, Bin Hoa City,  
Dong Nai Province, Vietnam  
Phone: +84 94 2623 979  
jhwon@nivuskorea.com  
www.nivus.com

## Copyrights and Property Rights

The contents of this document including tables and drawings are proprietary to NIVUS GmbH and are not to be reproduced or copied without express written permission.

Violations oblige to compensation.



---

### **Important**

*This instruction manual - even in parts - may exclusively be copied or translated in any other way with the express written consent of NIVUS GmbH.*

---

### **Translation**

If the device is sold to a country in the European Economic Area (EEA) this instruction manual must be translated into the language of the country in which the device is to be used . Should the translated text be unclear, the original instruction manual (German) must be consulted or the NIVUS GmbH must be contacted for clarification.

### **Copyright**

No part of this publication may be reproduced, transmitted, sold or disclosed without prior permission. All rights reserved.

### **Names**

The use of general descriptive names, trade names, trade-marks and the like in this manual does not entitle the reader to assume they may be used freely by everyone. They are often protected registered trademarks even if not marked as such.

## Revision History

Rev.	Date	Modifications	Editor	
04	2022-04-05	Correction service password in chapt.11.3.3	KG	
03	2021-09-21	Complete revision, the main changes are:	KG	
		<b>Reason for Change</b>		<b>See</b>
		Subsidiaries: Corrections		P. 2
		Additional Device Versions - NLC0CLOGP - NLC0CLOGS		Chap. 4.1, Chap. 5.1, Chap. 7.2
		WBM Firmware Update		Chap. 9.4, Chap. 10
		Functional Extensions all Device Versions		Chap. 5.1, Chap. 6.11, Chap. 6.12, Chap. 8.5, Chap. 8.6, Chap. 8.7, Chap. 8.8, Chap. 11
		Change Controller		Chap. 5.4, Fig. 5-1, Chap. 6, Fig. 7-1, Fig. 7-4, Fig. 8-2, Fig. 14-1, EU Declaration of Conformity
		Amendments to NLC0CS70: - Watchdog Function - Settings on S7 PLC		Chap. 8.6
		Modification of the Maintenance Information		Chap. 14.1
EU Declarations of Conformity: - New EU Declaration of Conformity for Controller - Additional EU Declarations of Confor- mity for Output Terminal Clamps	Appendix			
02	2020-08-06	New Creation	KG	
01	--	Was skipped		
00	--	Was skipped		

---

## Table of Contents

<b>Copyrights and Property Rights .....</b>	<b>3</b>
<b>Revision History .....</b>	<b>4</b>
<b>1 General Product Information.....</b>	<b>9</b>
<b>2 General .....</b>	<b>9</b>
2.1 About this Manual .....	9
2.2 Applicable Documentation .....	9
2.3 Signs and Definitions used .....	10
2.3.1 Writing Conventions .....	10
2.3.2 Colour Codes for Wires and Single Conductors.....	10
2.3.3 Abbreviations used .....	11
2.4 Warranty .....	11
2.5 Disclaimer .....	12
2.6 Support .....	12
<b>3 Safety Instructions .....</b>	<b>13</b>
3.1 Used Symbols and Signal Words .....	13
3.2 Security Measures and Precautions.....	14
3.3 Intended Use .....	16
3.4 Duties of the Operator .....	16
3.5 Requirements for the Personnel.....	17
<b>4 Delivery, Storing and Transport.....</b>	<b>18</b>
4.1 Scope of Delivery.....	18
4.2 Inspection upon Receipt .....	18
4.3 Storage .....	18
4.4 Transport .....	19
4.5 Return .....	19
<b>5 Product Specification .....</b>	<b>19</b>
5.1 Device Versions.....	19
5.2 Product Overview .....	20
5.3 Device ID .....	21
5.3.1 Labelling .....	21
5.3.2 ID Plate .....	22
5.4 LED Indication Field Bus/System .....	23
5.4.1 Status-LEDs.....	23
5.4.2 Data Service Status.....	24
5.4.3 Network Status .....	24

5.4.4	System Status.....	25
5.4.5	PLC Program Status.....	25
5.4.6	Internal Data Bus Status.....	26
5.4.7	Module status .....	26
5.4.8	Connection Status to Communication Hub .....	26
5.5	Mode Selector Switch .....	27
5.6	Input Terminal Clamps.....	28
5.7	Output Terminal Clamps.....	29
<b>6</b>	<b>Specifications .....</b>	<b>30</b>
6.1	Device Data .....	30
6.2	System Data .....	31
6.3	Power Supply.....	31
6.4	Clock.....	32
6.5	ETHERNET .....	32
6.6	Mobile Phone Modem.....	33
6.7	Wire Connection .....	33
6.8	Ambient Conditions.....	33
6.9	Analogue Input Clamp NLC07504530.....	34
6.10	Digital Input Clamp NLC07501405 .....	35
6.11	Analogue Output Clamp NLC07505520 .....	36
6.12	Digital Output Clamp NLC07505300 .....	37
<b>7</b>	<b>Installation .....</b>	<b>38</b>
7.1	Installation Position.....	38
7.2	Dimensions .....	38
7.3	Mounting onto Carrier Rail.....	42
7.4	Spacing.....	43
7.5	Mounting Sequence.....	44
7.6	Mounting Controller .....	45
<b>8</b>	<b>Installation .....</b>	<b>46</b>
8.1	General Installation Information.....	46
8.2	Instructions for avoiding Electrostatic Discharge (ESD).....	46
8.3	Connect Conductor to CAGE CLAMP® .....	47
8.4	Power Supply Concept .....	48
8.4.1	Protection of the Electronics Power Supply .....	48
8.4.2	Equipotential bonding .....	49
8.5	NLC0CLOG, NLC0CLOGP and NLC0CLOGS .....	49
8.5.1	Analogue Inputs.....	49
8.5.1.1	Connection Wiring.....	49

8.5.1.2	Wiring Examples .....	50
8.5.1.3	Screening .....	51
8.5.2	Digital Inputs .....	53
8.5.3	Analogue Outputs .....	53
8.5.4	Digital Outputs .....	54
8.6	NLC0CS70 .....	54
8.7	NLC0CNF0 .....	56
<b>9</b>	<b>Commissioning .....</b>	<b>56</b>
9.1	Notes to the User .....	56
9.2	Switching On the Controller .....	56
9.3	Network settings .....	58
9.3.1	IP-Addresses NivuLink Compact and Host PC .....	58
9.3.2	Determine IP Address of the Host PC .....	59
9.3.3	Adjusting the IP Address of the Host PC .....	60
9.4	Deactivate / Restart Controller .....	61
9.5	Reset Functions .....	61
9.5.1	Warm Start Reset .....	61
9.5.2	Cold Start Reset .....	61
<b>10</b>	<b>Configuration via Web Based Management (WBM) .....</b>	<b>62</b>
10.1	Basic Instructions .....	62
10.2	Call Up WBM .....	63
10.3	WBM Start Screen .....	64
10.4	Change IP-Address of the NivuLink Compact .....	65
<b>11</b>	<b>Communication with NivuFlow Transmitters .....</b>	<b>66</b>
11.1	Default Settings on NivuLink Compact .....	66
11.2	Setting Parameters NivuFlow .....	67
11.3	Configuration NivuLink Compact: Web Visualisation .....	68
11.3.1	Call up the Web Visualisation .....	68
11.3.2	Start Screen of the Web Visualisation .....	68
11.3.3	Login .....	69
11.3.4	Configuration View of the Web Visualisation .....	69
11.3.5	Configure the NLC for the Use of NivuFlow Transmitters .....	70
<b>12</b>	<b>NIVUS WebPortal .....</b>	<b>71</b>
12.1	Basic Information .....	71
12.2	Verify Connection to NIVUS WebPortal .....	72
12.3	Process Variables .....	72
12.3.1	Edit Process Variable .....	73
12.3.2	Configuration Options or Process Variables .....	74

<b>13</b>	<b>Accessories and Extensions</b> .....	<b>75</b>
	13.1 NIVUS Accessories and Extensions.....	75
	13.2 WAGO Accessories .....	76
<b>14</b>	<b>Maintenance and Cleaning</b> .....	<b>77</b>
	14.1 Maintenance Interval .....	77
	14.2 Cleaning.....	77
	14.3 Customer Service Information .....	77
<b>15</b>	<b>Dismantling</b> .....	<b>78</b>
<b>16</b>	<b>Disposal</b> .....	<b>79</b>
	<b>Index</b> .....	<b>80</b>
	<b>EU Declarations of Conformity and UK Declarations of Conformity</b> ...	<b>82</b>



## 1 General Product Information

Devices, extensions and accessories of the NivuLink Control family are essentially based on the modular WAGO I/O SYSTEM 750 by WAGO Kontakttechnik GmbH & Co. KG, Minden.

This instruction manual contains several references to this group of products.

## 2 General

### 2.1 About this Manual



---

**Important**

*READ CAREFULLY BEFORE USE.*

*KEEP IN A SAFE PLACE FOR LATER REFERENCE.*

---

This instruction manual is intended for the correct installation or the intended use of the device versions of the NivuLink Compact, which are listed in Chapter 5.1. This instruction manual is oriented exclusively to qualified expert personnel.

Read this instruction manual carefully and completely prior to installation and commissioning since it contains relevant information on this product. Observe the notes and particularly follow the warning notes and safety instructions.

If you should have problems to understand information contained within this instruction manual either contact the NIVUS GmbH or one of the distributors for further support. The member companies of the NIVUS group cannot be held responsible for damage to persons or material due to incorrectly understood information in this instruction.

### 2.2 Applicable Documentation


For the installation and operation of the complete system extra instruction manuals or technical descriptions may be required apart from this manual.

- Instruction manuals for transmitters
- Technical descriptions for sensors
- Installation instructions for sensors
- NIVUS WebPortal handbook
- NICOS handbook

These manuals are provided with the auxiliary units or sensors and/or are available as download on the NIVUS homepage.

## 2.3 Signs and Definitions used

### 2.3.1 Writing Conventions

Representation	Meaning	Remarks
⇒	Cross-reference	Reference to further or detailed information
	Refers to a documentation	Refers to an accompanying documentation
<i>Path</i>	Path or file	Path to a file or file name
<i>https://address/</i>	URL Address	Internet address, not linked
<u>Hyperlink</u>	Hyperlink	Reference to a page or document on the Internet
<b>Menu</b>	Menu point	Name of a menu point
Menu > Submenu	Menu selection	Path to certain submenu or menu point
<b>Input field</b>	Input field	Name of input field
"Value"	Input or value to select	Value to be specified or selected by user
"Status"	Status or mode	Name of device status or device mode
<b>Button</b>	Button	Button labels in dialogues
<b>[Key]</b>		Key labels on keyboard
[Variable]	Variable	Placeholder for an entry-based or application-based value

Tab. 2-1 Font conventions

### 2.3.2 Colour Codes for Wires and Single Conductors

The abbreviations of colours for wire and single conductor labelling follow the international colour code according to IEC 60757.

BK	Black	BN	Brown	RD	Red
OG	Orange	YE	Yellow	GN	Green
BU	Blue	VT	Violet	GY	Grey
WH	White	PK	Pink	TQ	Turquoise
GNYE	Green/Yellow	GD	Gold	SR	Silver

Tab. 2-2 Colour codes for wires and single conductors

---

### 2.3.3 Abbreviations used

I/O	Input/Output
NF	NivuFlow
NLC	NivuLink Compact
PV	Process Variable
WBM	Web Based Management

## 2.4 Warranty

The device was functionally tested prior to shipping. When used for the intended purpose (see Chap. 3.3 *Intended Use*) and in compliance with the instruction manual, the applicable (see Chap. 2.2 *Applicable Documentation*) and the safety information and instructions contained therein, no functional restrictions are to be expected and flawless operation should be possible.

⇒ Please also refer to the following chapter *2.5 Disclaimer*.



#### **Limitation of Warranty**

*In case of disregarding the safety notes and instructions in this document, the companies of the NIVUS-Group reserve the right to limit the warranty.*

---

## 2.5 Disclaimer

### The companies of the NIVUS-Group assume no liability

- for consequential damages resulting from **a change** in this document. The companies of the NIVUS-Group reserve the right to change the contents of the document including this disclaimer without prior notice.
- for personal injury or damage to property resulting from **failure to comply** with the **applicable regulations**. For connection, commissioning and operation of the sensors, all information and higher-level legal regulations of the country (in Germany e.g. the VDE regulations), such as valid Ex regulations as well as the safety and accident prevention regulations applicable to the respective individual case shall be observed.
- for personal injury or damage to property resulting from **improper handling**. For safety and warranty reasons, all work on the equipment that goes beyond the installation and connection measures may only be carried out by NIVUS personnel or by persons or companies authorised by NIVUS.
- for personal injury or damage to property resulting from the operation of the equipment in a **technically faulty** condition.
- for personal injury or damage to property resulting from **improper use**.
- for personal injury or damage to property resulting from failure to observe the **safety instructions** in this instruction manual.
- for missing or incorrect readings due to **improper installation** and for any consequential damage resulting therefrom.
- for faults in the mobile network over which the NivuLink Compact communicates. The companies of the NIVUS-Group therefore disclaim any warranty for the transmission of messages and measured values.

The NivuLink Compact devices are delivered from the factory with a fixed hardware and software configuration for the respective application and do not contain any parts to be maintained or repaired by the user.

### Therefore the companies of the NIVUS-Group assume no liability

- for damage to property resulting from improper repairs.
- for changes to the hardware or software that are not described in the manual and for the resulting consequential damage.

## 2.6 Support

Contact the NIVUS support under:

- E-Mail: [hotline@nivus.com](mailto:hotline@nivus.com)
- Phone: +49 7262 9191-955

### 3 Safety Instructions

#### 3.1 Used Symbols and Signal Words

##### Information on the Valuation of Accident Levels:



The general warning symbol indicates the risk of personal injuries or death. In the text section the general warning symbol is used in combination with the signal words described below.

##### DANGER



##### **Warning in high degree of risk**

Indicates a high-risk, **imminently** hazardous situation which will result in death or serious injury if not avoided.

##### WARNING



##### **Warning in medium degree of risk and personal injury**

Indicates a **possible** danger with medium risk which may result in a life-threatening situation or (severe) bodily injury if not avoided.

##### CAUTION



##### **Warning in personal injury or property damage**

Indicates a possible danger with moderate risk which may result in minor or moderate personal injury or property damage if not avoided.

##### WARNING



##### **Danger by electric voltage**

Indicates a medium-risk, **imminently** hazardous situation caused by electric shock which will result in death or (serious) injury if not avoided.



##### **Important Note**

Contains information that needs to be highlighted.

Indicates a potentially harmful situation that may damage the product or something in its environment if not avoided.



##### **Note**

Contains tips or information.

## 3.2 Security Measures and Precautions

To install the unit in your plant and during operation observe the following safety information:

**DANGER**



***Danger of electric shock***

*Prior to installation, repairs or maintenance works:*

- *Always deactivate all power sources used for the unit.*

**DANGER**



***Risk of fire***

*NivuLink Compact is an open system.*

- *Operate NivuLink Compact only in lockable housings, cabinets or in electrical operating areas.*
- *Allow access only to qualified personnel by using a key or appropriate tools.*

**WARNING**



***Risk of personal injury***

*due to disregarding applicable accident prevention regulations.*

- *For installation, commissioning, operation, maintenance and repairs observe the accident prevention regulations that apply for your machine/plant such as the DGUV Regulation 3 "Electrical Plants and Equipment".*

**DANGER**



***Risk of personal injury and system malfunctions***

*due to improper connection.*

- *Observe to lay data lines and supply lines according to standards and make sure to use the correct terminal wiring.*
- *Observe the EMC directives that apply for your application.*

**CAUTION**



***Risk of plant malfunctions***

- *Use devices featuring ETHERNET-/RJ-45 connections only in LANs.*
- *Never connect such devices to telecommunications networks such as analogue or ISDN telephone systems.*

**CAUTION**



***Risk of malfunctions***

*due to defective or damages devices.*

- *Replace defective or damages devices (e.g. with deformed contacts).*

**CAUTION**



**Risk of equipment damage**

The units are not resistant to substances having seeping and insulating properties such as aerosols, silicones and triglycerides (as found in some hand creams).

- If you cannot be sure that such substances are likely to occur in the environment of the device: install the unit into a housing that is resistant to the above substances.
  - Use clean tools and materials when handling the device.
- 

**CAUTION**



**Risk of equipment damage**

due to improper cleaning.

- Clean enclosure and dirty contacts with propanol.
  - Do not use contact spray since the spray may impair contact area functionality in connection with contamination.
- 

**CAUTION**



**Risk of malfunctions**

Contact spray may impair contact area functionality in connection with contamination.

- Do not use contact spray.
- 

**CAUTION**



**Risk of equipment damage**

due to reverse polarity of data lines and power lines.

- Avoid reverse polarity.
- 

**CAUTION**



**Risk of equipment damage**

due to electrostatic discharge. Electronic components are integrated in the devices which may be destroyed when being touched as a result of electrostatic discharge.

- Observe the safety precautions against electrostatic discharge according to DIN EN 61340-5-1/-3.
  - Observe properly earthed environment (persons, workplace and packaging) when handling the device.
- 



**Commissioning to be carried out only by qualified personnel**

The entire measurement system shall be installed and put into operation by trained expert personnel only.

---

### 3.3 Intended Use



#### Note

*The device is intended exclusively for the purpose mentioned below. Any other use beyond this, any conversion or modification of the instrument without written agreement with the NIVUS GmbH is considered improper use.*

*The companies of the NIVUS-Group are not liable for any damage resulting from this. The operator alone bears the risk.*

Controller and input terminals of the modular NivuLink Compact serve to capture digital and analogue signals from sensors and to transmit such signals to the NIVUS WebPortal or other higher systems.

The components have been developed for use in an environment that meets the IP20 protection class criteria. There is a finger protection and protection against solid foreign bodies  $\geq 12.5$  mm, however, no protection against the ingress of water. Operating the units in wet and dusty environments is not allowed unless stated otherwise.

### 3.4 Duties of the Operator



#### Important Note

*In the EEA (European Economic Area), the national transposition of the Framework Directive (89/391/EEC) as well as the associated individual directives and, in particular, the Directive (2009/104/EC) concerning the minimum safety and health requirements for the use of work equipment by workers at work, as amended, must be observed and complied with. In Germany, the Ordinance on Industrial Safety and Health must be complied with.*

Obtain the local operating licence and observe the associated conditions. In addition, you must comply with environmental protection requirements and local legal requirements for the following:

- Safety of personnel (accident prevention regulations)
- Safety of work equipment (protective equipment and maintenance)
- Product Disposal (Waste Management Act)
- Materials Disposal (Waste Management Act)
- Cleaning (Cleaning Agents and Disposal)

#### Connections

As the operator, before activating the device, make sure that the local regulations (e.g. for the electrical connection) have been observed during installation and commissioning.



### **Keep the Instruction Manual for future Reference**

Keep this Instruction Manual in a safe place and ensure that it is always available and can be consulted by the user of the product.

### **Hand over the Instruction Manual**

When selling the NivuLink Compact this Instruction Manual must be handed over with it. The manual is part of the standard delivery.

## 3.5 Requirements for the Personnel

Requirements for the personnel carrying out installation, commissioning and maintenance works:

- Qualified personnel with sufficient knowledge in the fields of electrical engineering, automation technology and knowledge of the current standards and directives for the device and the automation environment
- Authorisation by plant operator

Requirements for the personnel carrying out interventions in the control system:

- Sufficient knowledge of PLC programming
- Authorisation by plant operator



### **Qualified Personnel**

*in the sense of these instructions or the warnings on the product itself are persons who are familiar with the installation, assembly, commissioning and operation of the product and who have the qualifications appropriate to their job, such as*

- I. Training and instruction or authorisation to switch circuits and devices/systems on and off, to earth and to label them in accordance with the standards of safety technology.*
  - II. Training or instruction in accordance with safety technology standards in maintenance and use of appropriate safety equipment.*
  - III. First Aid Training*
-

## 4 Delivery, Storing and Transport

### 4.1 Scope of Delivery

The standard delivery of the NivuLink Compact contains:

Component	Art No. NivuLink Compact									
	NLC0CLOGE0	NLC0CLOGEG	NLC0CLOGPE0	NLC0CLOGPEG	NLC0CLOGSE0	NLC0CLOGSEG	NLC0CS70E0	NLC0CS70EG	NLC0CNF0E0	NLC0CNF0EG
Controller	1	1	1	1	1	1	1	1	1	1
Analogue Input Clamp NLC07504530	2	2	2	2	1	1				
Digital Input Clamp NLC07501405	1	1	1	1	1	1				
Analogue Output Clamp NLC07505520			1	1						
Digital Output Clamp NLC07505300			1	1						
Bus Terminal Clamp NLC07506000	1	1	1	1	1	1	1	1	1	1
Memory-Card NLC075808790	1	1	1	1	1	1	1	1	1	1
Antenna ZUB0ANT01	1	1	1	1	1	1	1	1	1	1
SIM Card		1		1		1		1		1
Network Cable							1	1	1	1

Tab. 4-1 Scope of delivery

Check additional accessories depending on your order and by using the delivery note.

### 4.2 Inspection upon Receipt

Check the delivery for completeness and apparent intactness immediately after receipt. Report any transport damage immediately to the delivering carrier. Also send a written report to NIVUS GmbH in Eppingen.

Incomplete deliveries must be addressed in writing within 2 weeks to your responsible representative or directly to the head office in Eppingen.



***It is essential to observe the two-week deadline.***

*Complaints received later will not be recognised.*

### 4.3 Storage

Be sure to observe the storage conditions as described in Chapter 6.8 *Ambient Conditions*. Store the device in the original packaging.

## 4.4 Transport

Protect the device from strong impacts, shocks, jolts or vibrations.

Transport must be carried out in the original packaging.

## 4.5 Return

Send the unit to the NIVUS main office in Eppingen with carriage paid and in the original packaging.

Items that have not been sufficiently franked will not be accepted!

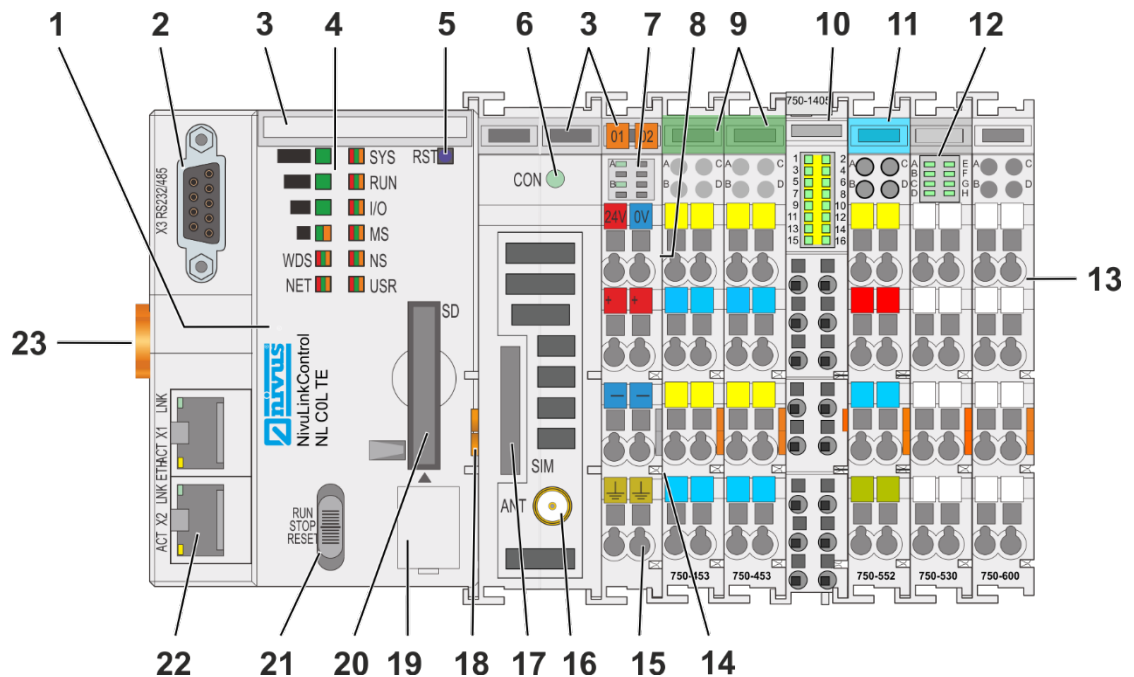
# 5 Product Specification

## 5.1 Device Versions

Art.-No.	Name	Connection
NLC0CLOGE0	NivuLink Compact Log	<ul style="list-style-type: none"> <li>- 8 Analogue inputs and 16 digital inputs</li> <li>- 6 NivuFlow transmitters with 1 measuring point or 3 NivuFlow transmitters with 3 measuring points</li> <li>- NivuCam</li> </ul>
NLC0CLOGEG	NivuLink Compact Log	
NLC0CLOGPE0	NivuLink Compact Plus	<ul style="list-style-type: none"> <li>- 8 Analogue inputs and 16 digital inputs</li> <li>- 2 Analogue outputs and 8 digital outputs</li> <li>- 6 NivuFlow transmitters with 1 measuring point or 3 NivuFlow transmitters with 3 measuring points</li> <li>- NivuCam</li> </ul>
NLC0CLOGPEG	NivuLink Compact Plus	
NLC0CLOGSE0	NivuLink Compact Small	<ul style="list-style-type: none"> <li>- 4 Analogue inputs and 16 digital inputs</li> <li>- 6 NivuFlow transmitters with 1 measuring point or 3 NivuFlow transmitters with 3 measuring points</li> <li>- NivuCam</li> </ul>
NLC0CLOGSEG	NivuLink Compact Small	
NLC0CS70E0	NivuLink Compact S7	<ul style="list-style-type: none"> <li>- S7-PLC with defined address range in DB100</li> <li>- 6 NivuFlow transmitters with 1 measuring point or 3 NivuFlow transmitters with 3 measuring points</li> <li>- NivuCam</li> </ul>
NLC0CS70EG	NivuLink Compact S7	
NLC0CNF0E0	NivuLink Compact NF	<ul style="list-style-type: none"> <li>- 6 NivuFlow transmitters with 1 measuring point or 3 NivuFlow transmitters with 3 measuring points</li> <li>- NivuCam</li> </ul>
NLC0CNF0EG	NivuLink Compact NF	

**Tab. 5-1 Device Versions**

## 5.2 Product Overview



- 1 Controller
- 2 Serial interface
- 3 Marking Options (Mini-WSB)
- 4 LED Indicators – System
- 5 Reset button (in hole)
- 6 LED indicators – Mobile radio network status
- 7 LED Indicators – Power Supply
- 8 Feed-in section (fixed component of controller, cannot be removed)
- 9 Analogue input clamp NLC07504530 (only for NLC0CLOG, NLC0CLOGP and NLC0CLOGS)
- 10 Digital input clamp NLC07501405 (only for NLC0CLOG, NLC0CLOGP and NLC0CLOGS)
- 11 Analogue output clamp NLC07505520 (only for NLC0CLOGP)
- 12 Digital output clamp NLC07505300 (only for NLC0CLOGP)
- 13 Bus terminal clamp NLC07506000
- 14 Power contacts for power supply of down-circuit clamps
- 15 CAGE CLAMP® Connections for Power Supply
- 16 Mobile radio antenna connection
- 17 Slot for SIM card
- 18 Releasing strap
- 19 Service Interface (behind the flap)
- 20 Slot for memory card
- 21 Mode selector switch
- 22 ETHERNET Connections
- 23 Safe Locking Feature

**Fig. 5-1 Overview NivuLink Compact**

### 5.3 Device ID

#### 5.3.1 Labelling

The front labelling includes:

- device designation,
- name of the display elements, connections and control elements,
- serial number with hardware and firmware version.

The side labelling includes:

- manufacturer's identification,
- connector pin assignment,
- manufacturing number,
- approval information.

#### Manufacturing Number

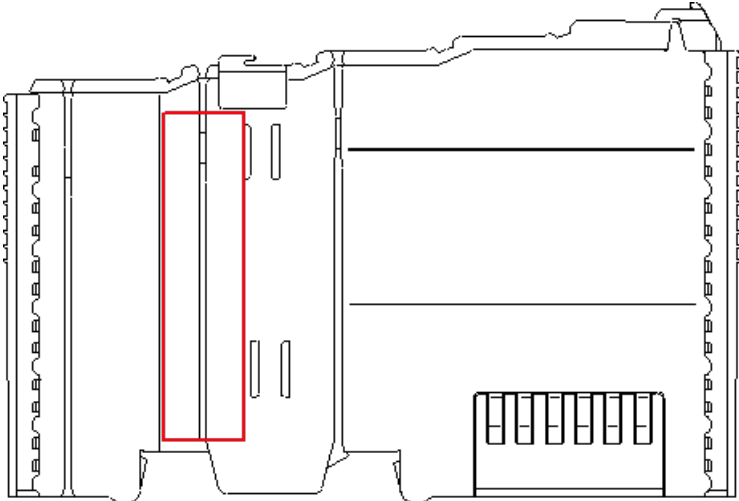


Fig. 5-2 Marking Area for Serial Numbers

There are two serial numbers in 2 rows in the side marking. They are left of the release tab. The first 10 positions in the longer row of the serial numbers contain version and date identifications.

Example structure of the rows: 0119010101...

<b>01</b>	<b>19</b>	<b>01</b>	<b>01</b>	<b>01</b>	...
<b>WW</b>	<b>JJ</b>	<b>FW</b>	<b>HW</b>	<b>FL</b>	-
Calendar week	Year	Firmware version	Hardware version	Firmware loader version	Internal information

### 5.3.2 ID Plate

The ID plate is fixed to the controller enclosure and contains the following information:

- Postal address of NIVUS GmbH
- Article Number
- ID number  
The first 4 digits of the ID number correspond with the manufacturing date (year and week no.) of the completed unit, e. g. 1903NLC0....

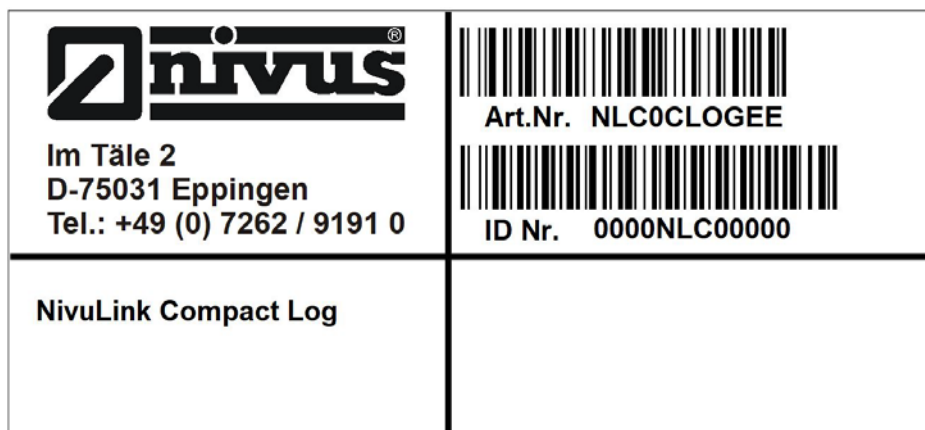


Fig. 5-3 ID plate of the NivuLink Compact

In case of enquiries and ordering replacement parts it is important to specify article number as well as the ID number of the respective device. This ensures correct and quick processing.



#### **Check ID plate**

*Use the ID plate to verify whether the device corresponds with your order.*

5.4 LED Indication Field Bus/System

Status-LED S4			SYS	System status
Status-LED S3			RUN	PLC program status
Status-LED S2			I/O	Internal data bus status
Status-LED S1			MS	Module status
Data service status			WDS	Without function
Network status			NET	Status of connection to communications hub

Fig. 5-4 LED-Indication for fieldbus/system

5.4.1 Status-LEDs

Status LEDs S1 – S4				Signal strength	Meaning		
(S1)	(S2)	(S3)	(S4)		UMTS	GSM	LTE
Off	Off	Off	Off	Level 0 No Service	No signal strength measurable or network access not registered		
Flashing yellow	Off	Off	Off	Level 1	Connection failures likely	Connection failures likely	LTE very unstable, connection failures very likely
Yellow	Off	Off	Off	Level 2	HSDPA possible, unstable depending on weather	GPRS with limited data rate	LTE unstable depending on weather (max. 2.5 MBit/s)
Green	Off	Off	Off	Level 3	HSDPA stable but fluctuating depending on weather	GPRS stable (max. 54 kbit/s)	LTE stable but fluctuating depending on weather (1.5 ... 10 MBit/s)
Green	Green	Off	Off	Level 4	HSDPA with limited data rate	EDGE with limited data rate	LTE with limited data rate (max. 25 MBit/s)
Green	Green	Green	Off	Level 5	HSDPA stable (max. 7.2 MBit/s)	EDGE stable (max. 220 kbit/s)	LTE stable (max. 50 MBit/s)
Green	Green	Green	Green	Level 6	HSPA+ possible (max. 42 MBit)	E-EDGE possible (max. 1 Mbit/s)	LTE-A possible (max. 150 MBit/s)

Tab. 5-2 Status LEDs

### 5.4.2 Data Service Status

LED	Status	Meaning
WDS	Off	Mobile data service is switched off
	Green	Mobile data service has been registered (successful registration of the data service).
	Yellow	Mobile data service is not available (e.g. due to poor reception conditions or scanning in progress).
	Red	Mobile data service has been refused (the provider has refused to register the data service).

### 5.4.3 Network Status

LED	Status	Meaning
NET	Off	System Start (Initialisation)
	Green	3G mobile network or 4G mobile network connected
	Yellow	2G mobile network connected
	Red	Mobile network not connected
	Flashing red (1 Hz)	Searching modem
	Flashing red, flash code 1-1	No or not readable SIM card
	Flashing red, flash code 1-2	Invalid/locked SIM card
	Flashing red, flash code 1-3	SIM card secured by PIN
	Flashing red, flash code 1-4	SIM card secured by PUK
	Flashing red, flash code 2-1	Modem not available, contact NIVUS hotline

Tab. 5-3 LED NET: Network status



## 5.4.4 System Status

LED	Status	Meaning
SYS	Green	Ready for operation - system start finished without any errors
	Yellow	Device starting up/booting with the RST pushbutton not pressed.
	Flashing yellow	"Fix IP Address" mode, temporary setting until next restart
	Flashing green/red	Firmware update mode
	Flashing yellow/red	No license, test period running.
	Flashing red	No license, test period expired.

Tab. 5-4 LED SYS: System status

## 5.4.5 PLC Program Status

LED	Status	Meaning
RUN	Green	Applications loaded and all in "RUN" status
	Flashing green	No application and no boot project loaded, contact NIVUS hotline
	Red	Applications loaded and all in "STOP" status
	Flashing green/red	At least one application each in "RUN" and "STOP" status
	Red, going out once briefly	Warm Start Reset executed
	Red, going out once longer	Cold Start Reset executed
	Flashing red	At least one application in "STOP" status after Exception (e. g. memory access error)
	Flashing yellow/green	Load above threshold value 1
	Yellow	Runtime system in debug condition (break point, single step, single cycle)
	Off	No runtime system loaded, contact NIVUS hotline

Tab. 5-5 LED RUN: Program status

### 5.4.6 Internal Data Bus Status

LED	Status	Meaning
I/O	Green	Data cycle on local bus, normal operating status
	Flashing yellow	Start-up period, local bus is initialised. Start-up is indicated by flashing rapidly for approx. 1 - 2 seconds.
	Red	Hardware defect
	Flashing red (2 Hz)	Possibly correctable error
	Flashing red (flash sequence)	Local bus error
	Off	A library was not loaded or a library function was not called up. Contact NIVUS hotline.

Tab. 5-6 LED I/O: Internal data bus status

### 5.4.7 Module status

(Input terminal clamp status)

LED	Status	Meaning
MS	Off	No error
	Flashing red (flash sequence)	Configuration error

Tab. 5-7 LED MS: Module status

### 5.4.8 Connection Status to Communication Hub

Der Controller checks every 3 minutes whether there is a data connection to NICOS or to the NIVUS WebPortal available. The USR-LED indicates the connection status. Can be used for diagnostic purposes on site.

LED	Status	Meaning
USR	Red	Connection disturbed
	Yellow	Connection control pending
	Green	Connected
	Flashing red/yellow/green	Monitoring running

Tab. 5-8 LED USR: status of connection to communication hub

5.5 Mode Selector Switch



Fig. 5-5 Mode selector switch

Position	Switch Mode	Function
RUN	Latching	<b>Normal operation</b> e!RUNTIME applications running
STOP	Latching	<b>Stop</b> All e!RUNTIME applications stopped
RESET	Momentary	<b>Reset warm boot:</b> actions > 2 - < 7 seconds <b>Reset cold boot:</b> actions > 7 seconds Detailed description see chapter. 9.5

Tab. 5-9 Functions of the mode selector switch in e!RUNTIME system

## 5.6 Input Terminal Clamps

(Only for NLC0CLOG, NLC0CLOGP and NLC0CLOGS)

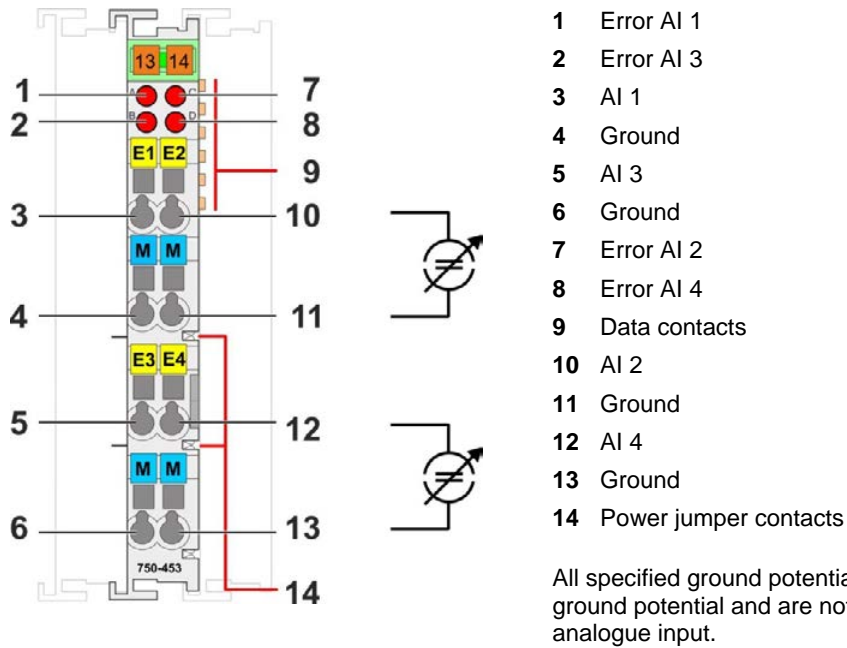


Fig. 5-6 Analogue input clamp NLC07504530

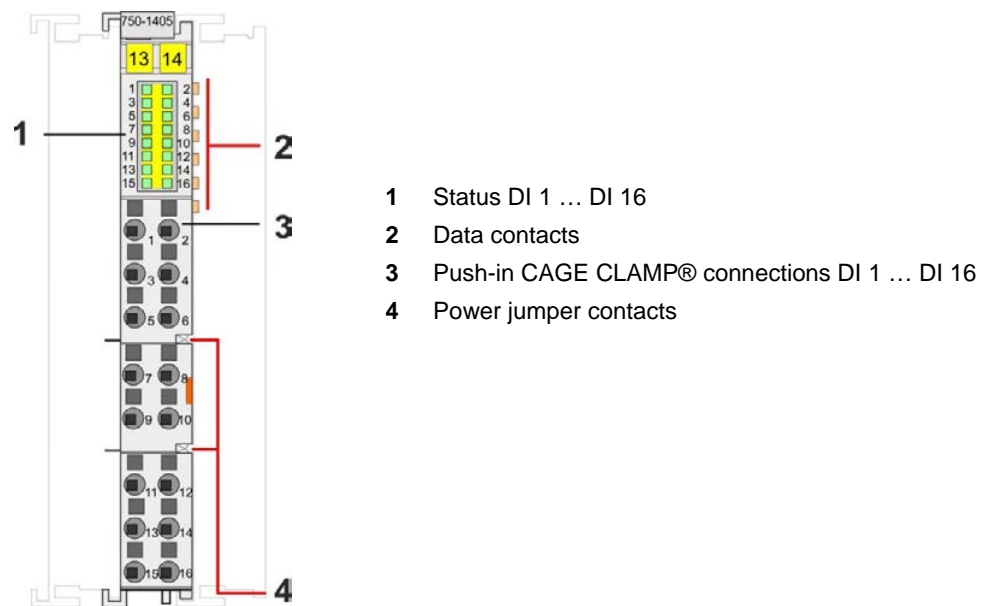


Fig. 5-7 Digital Input Clamp NLC07501405

5.7 Output Terminal Clamps

(Only for NLC0CLOGP)

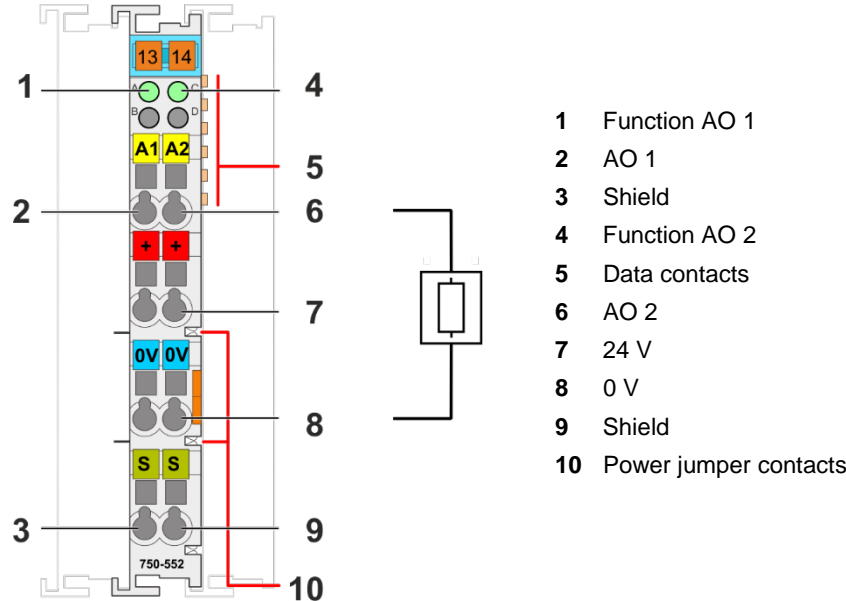


Fig. 5-8 Analogue output clamp NLC07505520

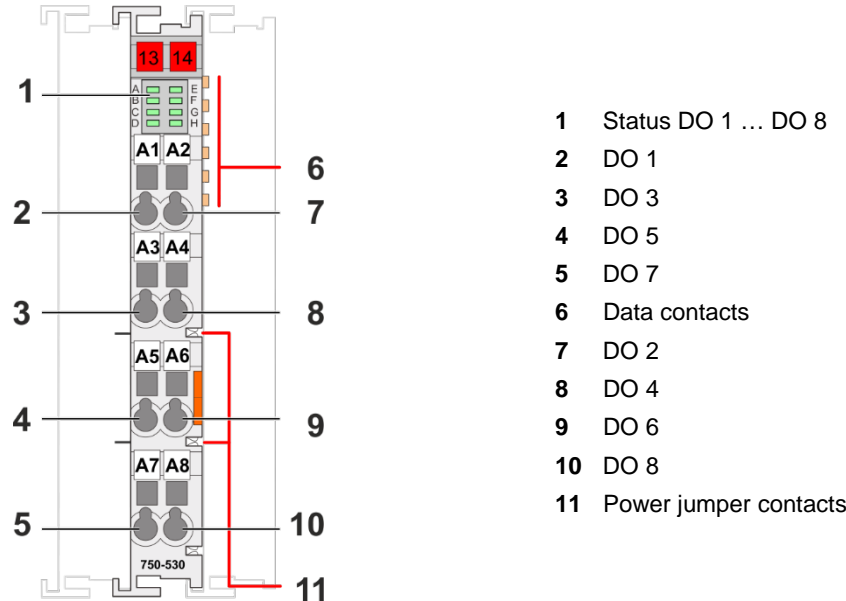


Fig. 5-9 Digital Output Clamp NLC07505300

## 6 Specifications

### 6.1 Device Data

#### Controller:

Width	102.5 mm
Height	100 mm
Depth (as of carrier rail top edge)	71.9 mm
Weight	288 g

Tab. 6-1 Technical data – device data controller

#### Analogue input clamp NLC07504530 (only for Art. NLC0CLOG, NLC0CLOGP and NLC0CLOGS)

Width	12 mm
Depth	69.8 mm
Depth (as of carrier rail top edge)	62.6 mm
Height	100 mm
Weight	51.2 g

Tab. 6-2 Technical data – Geometrical data analogue input clamp

#### Digital input clamp NLC07501405 (only for Art. NLC0CLOG, NLC0CLOGP and NLC0CLOGS)

Width	12 mm
Depth	69 mm
Depth (as of carrier rail top edge)	61.8 mm
Height	100 mm
Weight	47.5 g

Tab. 6-3 Technical data – Device data digital input clamp

#### Analogue output clamp NLC07505520 (only for Art. NLC0CLOGP)

Width	12 mm
Depth	69.8 mm
Depth (as of carrier rail top edge)	62.6 mm
Height	100 mm
Weight	51.1 g

Tab. 6-4 Technical data – Geometrical data analogue output clamp

**Digital output clamp NLC07505300 (only for Art. NLC0CLOGP)**

Width	12 mm
Depth	67.8 mm
Depth (as of carrier rail top edge)	60.6 mm
Height	100 mm
Weight	49 g

Tab. 6-5 Technical data – Geometrical data digital output clamp

**6.2 System Data**

CPU	Cortex A8, 1 GHz
Operating System	Realtime-Linux® with RT-Preemption-Patch
Memory card slot	Push-push mechanism, sealable cover lid
Type of memory card	SD and SDHC up to 32 GB (all guaranteed properties are valid only in connection with the NIVUS memory card NLC075808790.)

Tab. 6-6 Technical data – System data

**6.3 Power Supply**

System supply voltage	DC 24 V (SELV/PELV, -25 ... +30 %) - Feed via wiring level (CAGE CLAMP® connection)
Input current typ. at nominal load (24 V system)	550 mA
Power failure time acc. to IEC 61131-2	Depending on external buffering
Internal system voltage	DC 5 V (generated by built-in power adapter)
Total current for clamps (5 V)	700 mA
Field power supply	DC 24 V (SELV/PELV, -25 ... +30 %) - Feed via wiring level (CAGE CLAMP® connection) - Routing via power jumper contacts
Number of output power contacts	3
Current carrying capacity of power contacts	10 A
Electrical isolation	500 V DC 1 min., (between system level and field level)

Tab. 6-7 Technical Data – Power supply

***Buffer for system power supply!***

*The system power supply must be buffered to bridge power outages. As the power demand depends on the respective node configuration, buffering is not implemented internally.*

*To achieve power outages of 1 ms to 10 ms according to IEC61131-2, determine the buffering appropriate for your node configuration and structure it as an external circuit.*

### 6.4 Clock

Drift – system clock (25 °C)	20 ppm
Drift - RTC (25 °C)	3 ppm
Buffer time RTC (25 °C)	30 days

**Tab. 6-8 Technical data – Clock**

### 6.5 ETHERNET

ETHERNET	2 x RJ-45 (switched mode or separated mode)	
Transmission medium	Twisted Pair S-UTP, 100 Ω, Cat 5, 100 m maximum cable length	
Baud rate	10/100 Mbit/s; 10Base-T/100Base-TX	
Protocols	DHCP, DNS, SNTP, FTP, FTPS (only explicit connections), SNMP, HTTP, HTTPS, SSH, MODBUS (TCP, UDP)	
MODBUS input and output process image, max.	<b>e!RUNTIME</b>	32,000 Words

**Tab. 6-9 Technical data – ETHERNET**



***No direct access from fieldbus to the process image of the terminals!***

*Any data that is required from the local bus process image must be explicitly mapped in the CODESYS program to the data in the fieldbus process image and vice versa! Direct access is not possible!*



## 6.6 Mobile Phone Modem

Communication Technology	GSM / Edge / UMTS / HSPA+ / LTE
LTE Category	Cat 4 (150Mbps (DL) / 50Mbps (UL))
Frequency Band	GSM Dual Band (B3 / B8), E-UTRA Bands (B1 / B3 / B5 / B7 / B8 / B20 / B38 / B40 / B41)
Services	GPRS connection to the Internet
Security Encryption	OpenVPN; IPsec; Firewall
SIM card type	Mini SIM (Temperature range: -20 ... +85 °C)
SIM card slot	Push/push mechanism

Tab. 6-10 Technical data – Mobile Phone Modem

## 6.7 Wire Connection

Wire connection	CAGE CLAMP®
Cross section	0.08 mm <sup>2</sup> ... 2.5 mm <sup>2</sup> , AWG 28 ... 14
Stripped lengths	8 mm ... 9 mm / 0.33 in

Tab. 6-11 Technical data – Field wiring

Power jumper contacts	Spring contact, self-cleaning
-----------------------	-------------------------------

Tab. 6-12 Technical Data – Power jumper contacts

Data contacts	Slide contact, hard gold plated, self-cleaning
---------------	--

Tab. 6-13 Technical Data – Data contacts

## 6.8 Ambient Conditions

Protection	IP20
Ambient temperature range (operation)	0 ... 55 °C
Ambient temperature range (storage)	-25 °C ... +85 °C
Relative humidity	5 % ... 95 %, without condensation
Resistance to harmful substances	According to IEC 60068-2-42 and IEC 60068-2-43
Maximum pollutant concentration at relative humidity < 75 %	SO <sub>2</sub> ≤ 25 ppm H <sub>2</sub> S ≤ 10 ppm
Special conditions	The components may not be used without additional measures in locations where dust, caustic vapours, gases or ionising radiation may occur.

Tab. 6-14 Technical data – Climatic environmental conditions

## 6.9 Analogue Input Clamp NLC07504530

(Only for Art. NLC0CLOG, NLC0CLOGP and NLC0CLOGS)

Number of analogue inputs	4
Total number of channels (input terminals)	4
Signal type	Current
Current signal type	DC 0 ... 20 mA
Sensor connection	4 x (2-wire)
Max. input voltage	32 V
Signal characteristics	Single-Ended
Resolution [Bit]	12 Bit
Max. input resistance	100 $\Omega$
Data width	4 x 16 Bit data; 4 x 8 Bit control/status (optional)
Typ. conversion period	10 ms
Measurement error, reference temperature	25 $^{\circ}\text{C}$
Measurement error, max. deviation from full scale end value	0.1 %
Max. temperature error from full scale end value	0.01 %/K
System supply voltage	DC 5 V; via data contacts
Power consumption system supply (5 V)	65 mA
Field power supply	DC 24 V (-25 ... +30 %); via power contacts (fed through blade contact; distribution via spring contact)
Electrical isolation	500 V system/field
Number of input power contacts	2
Number of output power contacts	2
Current carrying capacity of power contacts	10 A

**Tab. 6-15 Technical Data – Analogue input clamp**

## 6.10 Digital Input Clamp NLC07501405

(Only for Art. NLC0CLOG, NLC0CLOGP and NLC0CLOGS)

Number of digital inputs	16
Total number of channels (input terminals)	16
Signal type	Voltage
Current signal type	DC 24 V
Sensor connection	16 x (1-wire)
Input characteristic	positive-switching
Input filter (digital)	3 ms
Typ. input current per channel with signal (0)	0.6 mA
Min. input current per channel with signal (1)	2.1 mA
Max. input current per channel with signal (1)	2.4 mA
Voltage range for signal (0)	DC -3 ... +5 V
Voltage range for signal (1)	DC 15 ... 30 V
Max. data width of input data (internal)	16 Bit
System supply voltage	DC 5 V; via data contacts
Power consumption system supply (5 V)	25 mA
Field power supply	DC 24 V (-25 ... +30 %); via power contacts (fed through blade contact; distribution via spring contact)
Electrical isolation	500 V system/field
Indicating elements	LED (1-16) Green: Status DI 1 ... DI 16
Number of input power contacts	2
Number of output power contacts	2
Current carrying capacity of power contacts	10 A

Tab. 6-16 Technical Data – Digital input clamp

## 6.11 Analogue Output Clamp NLC07505520

(Only for Art. NLC0CLOGP)

Number of analogue outputs	2
Total number of channels (output terminals)	2
Signal type	Current
Current signal type	DC 0 ... 20 mA
Actuator connection	2 x (2-wire)
Resolution [Bit]	12 Bit
Data width	2 x 16 Bit data; 2 x 8 Bit control/status (optional)
Current output load	≤ 600 Ω
Typ. conversion period	2 ms
Measurement error, reference temperature	25 °C
Measurement error, max. deviation from full scale end value	0.1 %
Max. temperature error from output range end value	0.01 %/K
Linearity	±10 µA
System supply voltage	DC 5 V; via data contacts
Power consumption system supply (5 V)	70 mA
Field power supply	DC 24 V (-25 ... +30 %); via power contacts (fed through blade contact; distribution via spring contact)
Electrical isolation	500 V system/field
Number of input power contacts	2
Number of output power contacts	2

**Tab. 6-17 Technical data – Analogue output clamp**

## 6.12 Digital Output Clamp NLC07505300

(Only for Art. NLC0CLOGP)

Number of digital outputs	8
Total number of channels (output terminals)	8
Signal type	Voltage
Signal type voltage	DC 24 V
Actuator connection	8 x (1-wire)
Output characteristics	positive-switching
Output current per channel	0.5 A
Output current	short-circuit proof
Max. switching frequency	2 kHz
Load type	ohmic, inductive, lamp load
Absorbable energy max. (single switch-off)	0.9 J
Max. data width of output data (internal)	8 Bit
System supply voltage	DC 5 V; via data contacts
Power consumption system supply (5 V)	15 mA
Field power supply	DC 24 V (-25 ... +30 %); via power contacts (fed through blade contact; distribution via spring contact)
Current consumption field supply (terminal without external load)	15 mA
Electrical isolation	
Indicating elements	
Number of input power contacts	2
Number of output power contacts	2
Current carrying capacity of power contacts	10 A

**Tab. 6-18 Technical data – Digital output clamp**

## 7 Installation

### 7.1 Installation Position

Along with horizontal and vertical installation, all other installation positions are allowed.



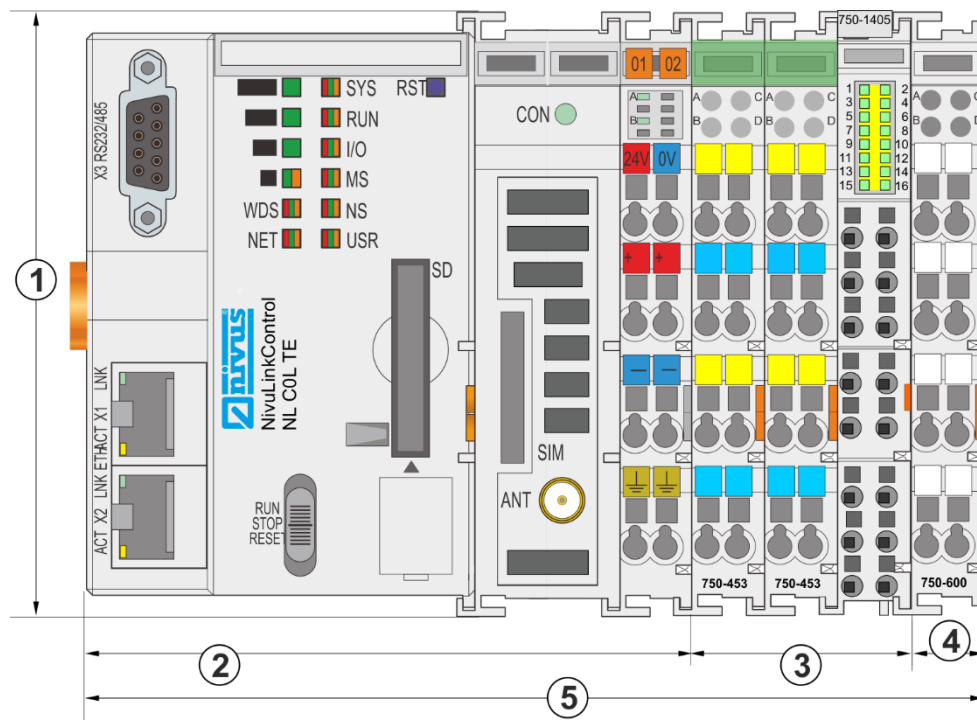
**Use an end stop clamp in the case of vertical mounting!**

*In the case of vertical assembly an extra end stop has to be mounted underneath the field-bus node as an additional safeguard against slipping.*

⇒ End stop clamps by WAGO see Chapter 13.2

### 7.2 Dimensions

#### NLC0CLOG



1	Height	100 mm
2	Width controller	102.5 mm
3	Width 3 input clamps (2 x analogue, 1 x digital)	36 mm
4	Width bus terminal clamp	12 mm
5	Total width	150.5 mm

Fig. 7-1 Dimensions NLC0CLOG (top view)

NLC0CLOGP

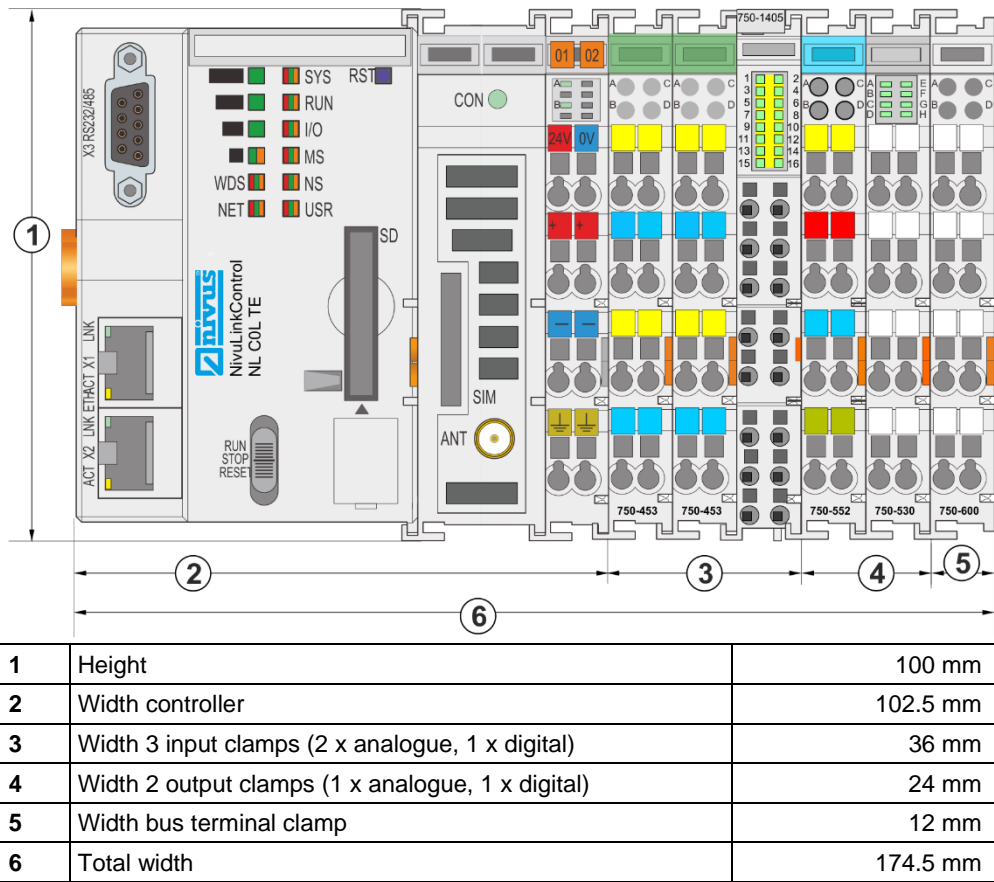
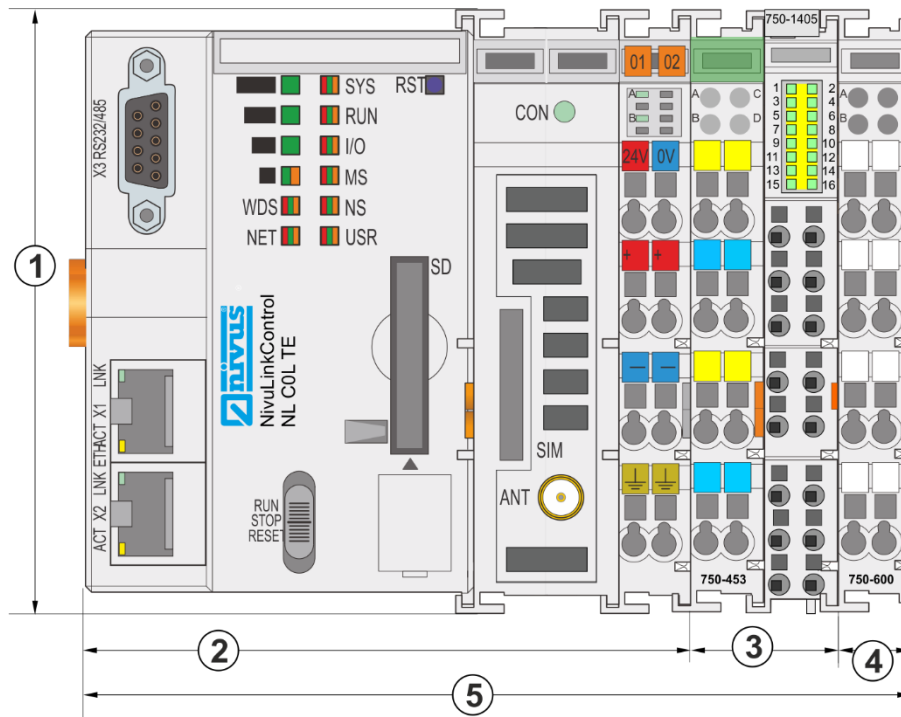


Fig. 7-2 Dimensions NLC0CLOGP (top view)

**NLC0CLOGS**

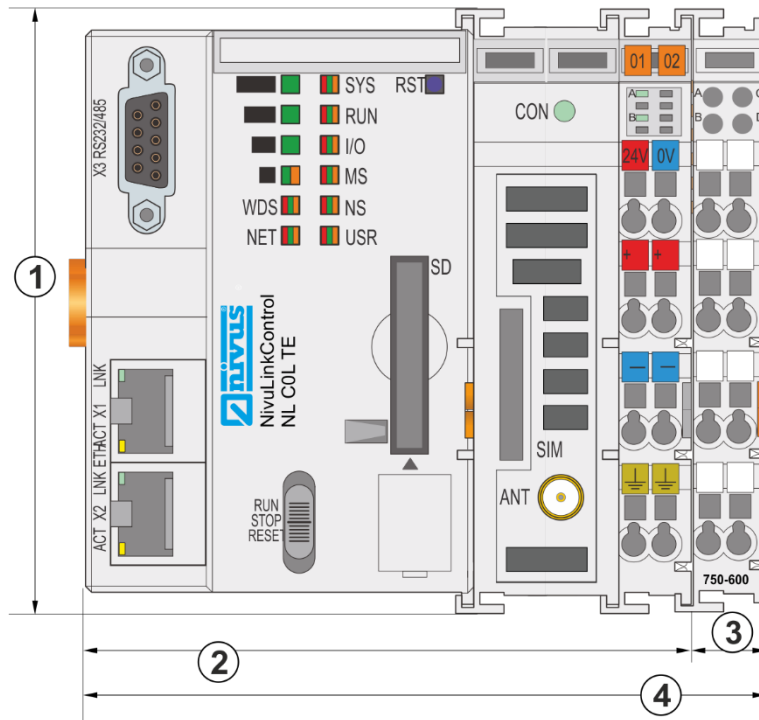


1	Height	100 mm
2	Width controller	102.5 mm
3	Width 2 input clamps (1 x analogue, 1 x digital)	24 mm
4	Width bus terminal clamp	12 mm
5	Total width	138.5 mm

**Fig. 7-3 Dimensions NLC0CLOGS (top view)**

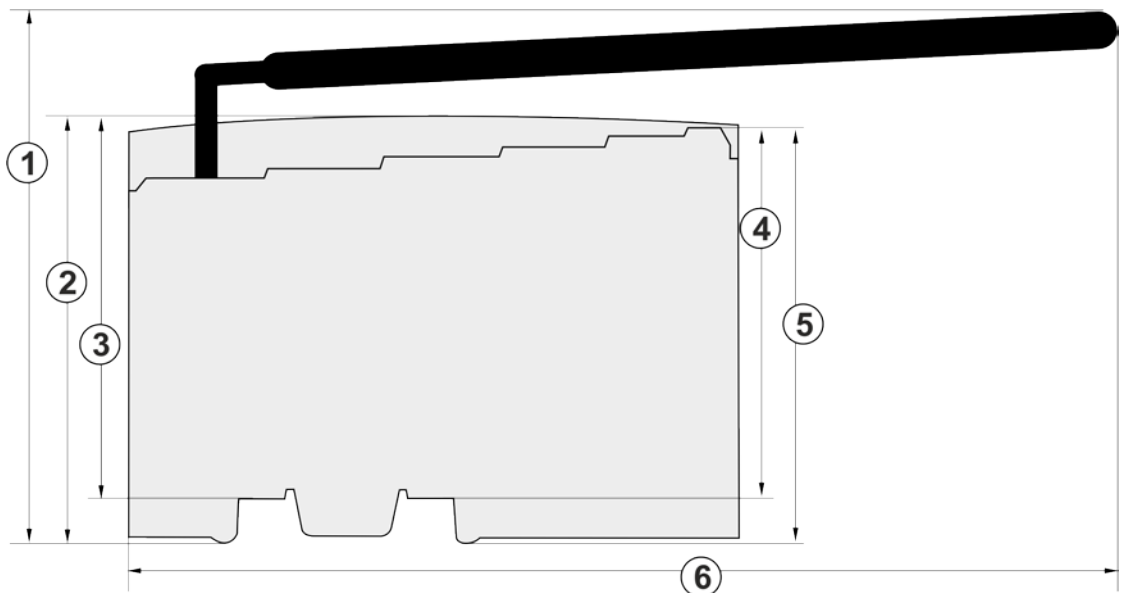


**NLC0CS70 and NLC0CNF0**



1	Height	100 mm
2	Width controller	102.5 mm
3	Width bus terminal clamp	12 mm
4	Total width	114.5 mm

**Fig. 7-4 Dimensions NLC0CS70 and NLC0CNF0 (top view)**



1	Depth with antenna	117.0 mm
2	Depth controller	71.9 mm
3	Depth controller as of carrier rail top edge	64.7 mm
4	Depth clamp	67.8 mm
5	Depth clamp as of carrier rail top edge	60.6 mm
6	Mounting space with antenna	175.0 mm

**Fig. 7-5 Dimensions Nivulink Compact with clamps (side view)**

### 7.3 Mounting onto Carrier Rail

All components of the system can be snapped directly onto a mounting rail according to EN 50022 (TS 35, DIN Rail 35).



---

**Do not use any third-party carrier rails without approval by WAGO!**

*WAGO supplies standardised carrier rails that are optimal for use with NivuLink Compact. Wenn Sie andere Tragschienen einsetzen, dann muss eine technische Untersuchung und eine Freigabe durch WAGO Kontakttechnik GmbH & Co. KG vorgenommen werden.*

---

#### Carrier rail requirements

Carrier rails have different mechanical and electrical properties. For the optimal system setup on a carrier rail, certain guidelines must be observed:

- The material must be non-corrosive.
- Most components have a contact to the carrier rail to ground electro-magnetic disturbances. In order to avoid corrosion, this tin-plated carrier rail contact must not form a galvanic cell with the material of the carrier rail which generates a differential voltage above 0.5 V (saline solution of 0.3 % at 20°C).
- The carrier rail must optimally support the EMC measures integrated into the system and the screening of the input/output terminals connection.
- A sufficiently stable carrier rail should be selected and, if necessary, several mounting points (every 20 cm) should be used in order to prevent bending and twisting (torsion).
- The geometry of the carrier rail must not be changed to ensure that the components are held securely. Especially when shortening and mounting, the carrier rail must not be squeezed or bent.
- The base of the components extends into the profile of the carrier rail. For carrier rails with a height of 7.5 mm, mounting points are to be riveted under the node in the carrier rail (slotted head captive screws or blind rivets).
- The metal springs on the bottom of the housing must have low-impedance contact with the DIN rail (wide contact surface is possible).

#### Observe for increased vibration and shock loads:

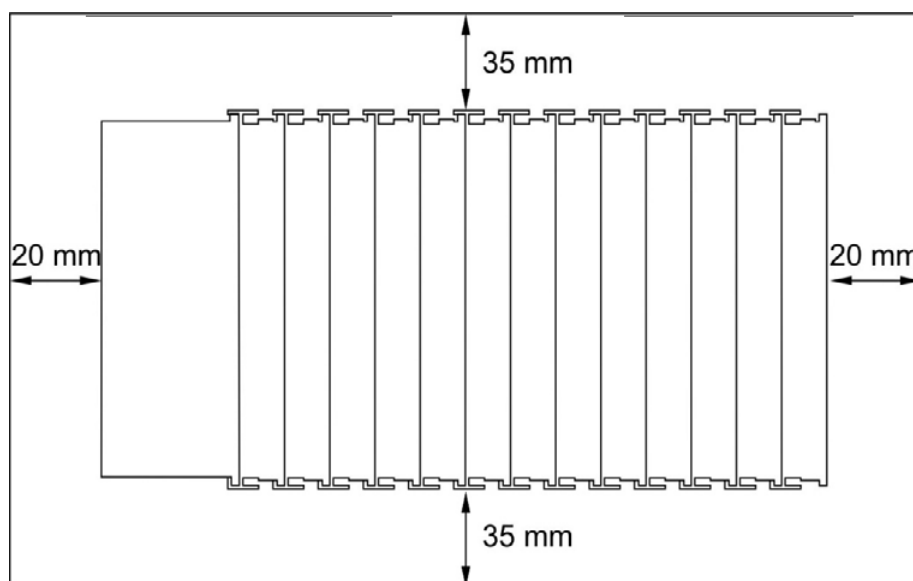
- Install carrier rail with a maximum fastening distance of 60 mm.

WAGO carrier rails meet the electrical and mechanical requirements.

⇒ WAGO carrier rails see Chapter 13.2

## 7.4 Spacing

The following distances between adjacent components, cable conduits, enclosure and frame sides must be maintained for the complete fieldbus node:



**Fig. 7-6 Distances field bus node – adjacent objects**

The spacing

- creates room for heat transfer, installation or wiring,
- to cable conduits also prevents conducted electromagnetic interferences from influencing the operation.

### 7.5 Mounting Sequence

---

**CAUTION****Risk of personal injury**

through sharp-edged blade contacts.

- Handle terminal clamps with care.
- 

**Basic mounting information:**

- Snap NivuLink Compact controller and terminals directly onto a carrier rail according to EN 50022 (TS 35).
- Connection: groove and tongue system.
- Automatic locking for secure hold on the carrier rail.

**Construction of terminal clamps:**

- All terminal clamps are equipped with a groove on the right-hand side for the insertion of blade contacts.
- On some terminal clamps the grooves are locked on the top. It is not possible to insert terminal clamps with blade contacts on the left into such terminal clamps from the top right. This mechanical coding helps to avoid configuration errors which might destroy the components.

**Mounting sequence:**

1. Controller
2. Terminal clamps according to project planning  
**Observe during installation:** to recognise and avoid configuration errors always plug terminals from the top and the right.  
**Basic order of terminal clamps:**
  - a) intelligent input clamps
  - b) analogue input clamps
  - c) digital input clamps
  - d) intelligent output clamps
  - e) analogue output clamps
  - f) digital output clamps
3. **Bus termination:** terminate by using a bus terminal clamp in order to ensure correct data transmission.

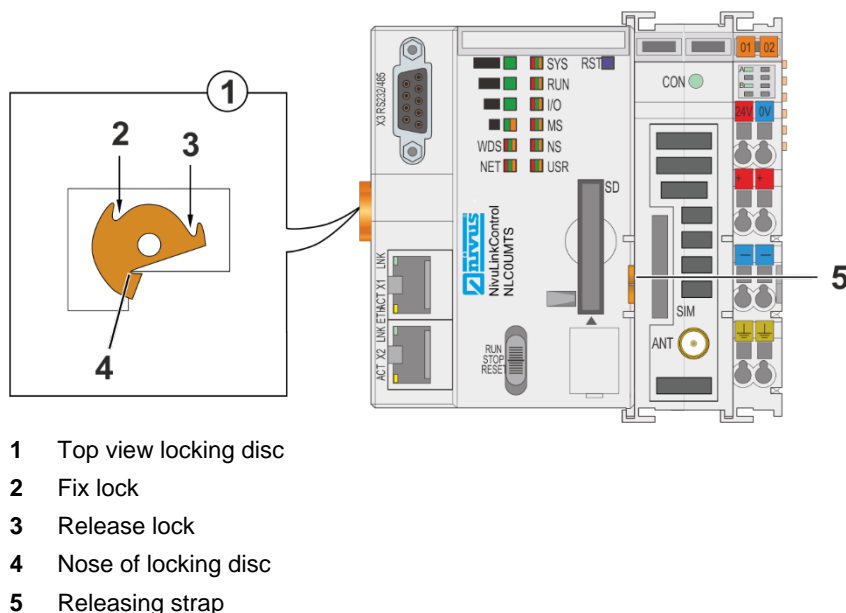
## 7.6 Mounting Controller

### CAUTION



**Risk of equipment damage**  
due to working on live systems.

- Disconnect equipment from mains power prior to working on the devices.



- 1 Top view locking disc
- 2 Fix lock
- 3 Release lock
- 4 Nose of locking disc
- 5 Releasing strap

**Fig. 7-7 Controller locking**

### Inserting the Controller:

1. Place the controller on the carrier rail.  
When replacing the controller for an already available controller, position the new controller so that the tongue and groove joints to the subsequent clamp are engaged.
2. Snap the controller onto the carrier rail.
3. Use a screwdriver blade to rotate the locking disc until the nose is latching behind the carrier rail (see Fig. 7-7).  
→ Controller is secured on the carrier rail against tilting.  
→ With the controller snapped in place, the electrical connections for the data contacts and power contacts (if any) to the possible subsequent clamp established.

## 8 Installation

### 8.1 General Installation Information

Observe the following information on installation:

- Observe that the installation shall be carried out only by qualified expert personnel.
- For electric installation follow the legal requirements of the according country (in Germany: e. g. VDE 0100).
- Observe further statutory standards, regulations and technical rulings.
- Before feeding the rated voltage the installation must be completed. Verify whether the installation is correct.



---

#### **Important hints on installation**

- *Ensure proper installation.*
  - *Follow applicable legal or operational guidelines.*
  - *Improper handling may lead to personal injuries and/or equipment damage.*
- 

### 8.2 Instructions for avoiding Electrostatic Discharge (ESD)

When connections are made to the NivuLink Compact, the following warnings and notes must be observed as well as warnings and notes found in the individual chapters.

**WARNING**



---

#### **Risk of electric shock**

- *Disconnect the system from the mains power before starting maintenance, cleaning and/or repair work (only by qualified personnel).*
- 

The sensitive electronic components inside the unit can be damaged by static electricity which can impair the device's performance or even cause it to fail. NIVUS GmbH recommend the following steps to prevent damage to the device due to electrostatic discharge:

- Discharge any static electricity possibly present on your body before you touch electronic components of the device (such as circuit boards and the components on them). To do this, you can touch an earthed metallic surface, such as the enclosure frame of a device or a metal pipe.
- Avoid unnecessary movements to reduce the building-up of static charges.
- Transport static-sensitive components in antistatic containers or packaging.
- Wear an anti-static wristband that is earthed via a cable to discharge your body and keep it free from static electricity.
- Only touch components that are sensitive to charges in an anti-static work area. If possible, use antistatic floor coverings and work pads.

### 8.3 Connect Conductor to CAGE CLAMP®

**CAUTION**

**Select conductor cross sections as required for current load!**

The current consumed for field-side supply may not exceed 10 A. The wire cross sections must be sufficient for the maximum current load for all of the input/output terminal clamps to be supplied with power.

**Observe for connection:**

- The WAGO CAGE CLAMP® connection is appropriate for solid, stranded and finely stranded conductors.
- Connect only one conductor per CAGE CLAMP®.
- If multiple conductors are to be applied to one connection connect them by using an upstream wiring such as WAGO through terminal blocks.

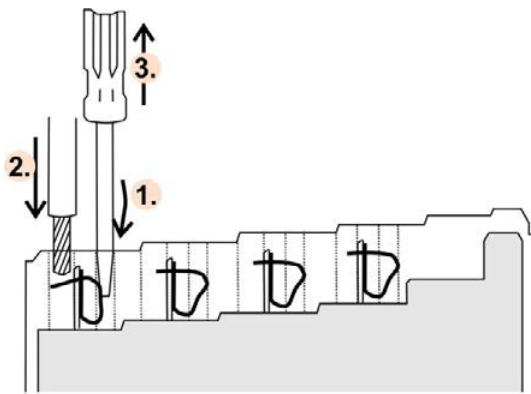


Fig. 8-1 Connect conductor to CAGE CLAMP®

**Procedure:**

1. Insert the operating tool into the opening of the CAGE CLAMP® above the connection.  
→ The CAGE CLAMP® will open.
2. Insert the conductor into the corresponding connection opening.
3. Then remove the operating tool.  
→ The CAGE CLAMP® will close and the conductor is clamped firmly.

## 8.4 Power Supply Concept

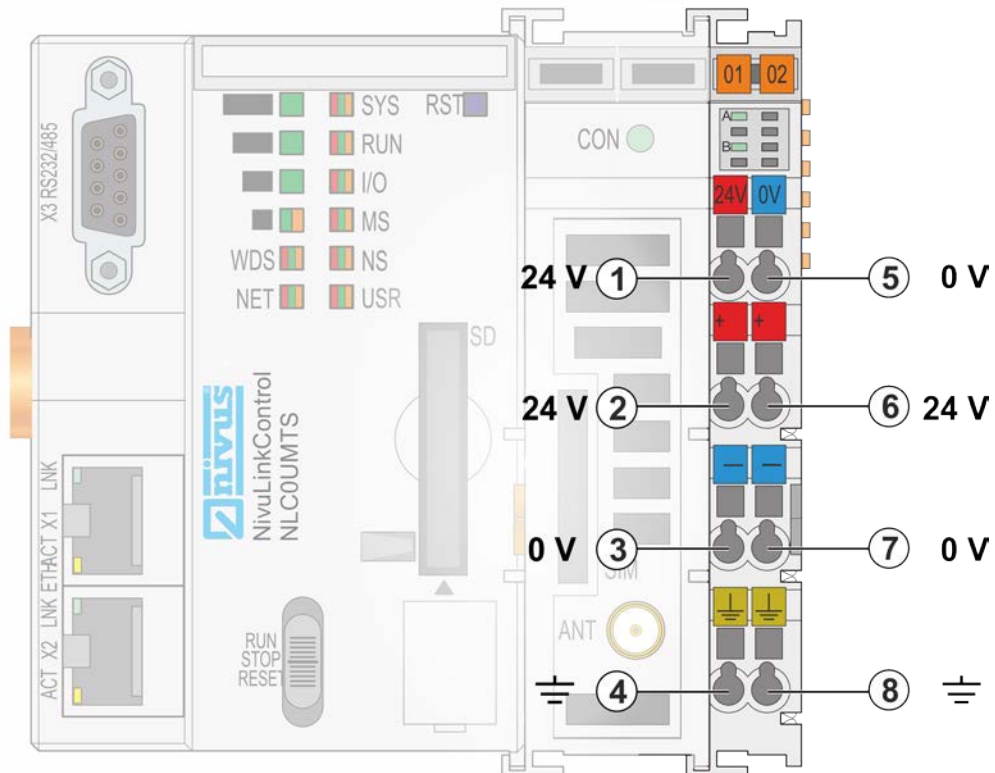
### 8.4.1 Protection of the Electronics Power Supply

**CAUTION**



**Power electronic components only with appropriate protection measures!**

Power the electronic components of the controller only through connectors 1 and 5 using a 2 A slow-blow fuse. Higher currents may damage the electronic components.



Connector	Name	Description
1	24 V	System supply voltage +24 V
2	+	Field supply voltage $U_v$
3	-	Field supply voltage 0 V
4	Ground	Field supply voltage Ground
5	0 V	System supply voltage 0 V
6	+	Field supply voltage $U_v$
7	-	Field supply voltage 0 V
8	Ground	Field supply voltage Ground

**Fig. 8-2 Protection of electronics power supply**



### 8.4.2 Equipotential bonding



**For equipotential bonding use a potential supply module!**

If you wish to use the lower power contact for equipotential bonding e.g. between screen connections and you need an extra terminal for such a potential use an additional WAGO Potential Supply Module 750-601/ 602/ 610 downstream of the WAGO Power Supply Filter 750-626.

## 8.5 NLC0CLOG, NLC0CLOGP and NLC0CLOGS

Communication Options of NLC0CLOG, NLC0CLOGP and NLC0CLOGS Devices:

Communication Partner	ETHERNET Interface	Configuration NLC
Max. 6 NivuFlow transmitters with 1 measuring point each <b>or</b> 3 NivuFlow transmitters with 3 measuring points each	Port X1	NLC see Chap. 11.3 NF see Chap. 11.2
NivuCam	Port X2	None (Plug & Play)

Tab. 8-1 NLC0CLOG, NLC0CLOGP and NLC0CLOGS: Communication Options

⇒ All further information on communication with NivuFlow transmitters see Chap. 11

### 8.5.1 Analogue Inputs

#### 8.5.1.1 Connection Wiring

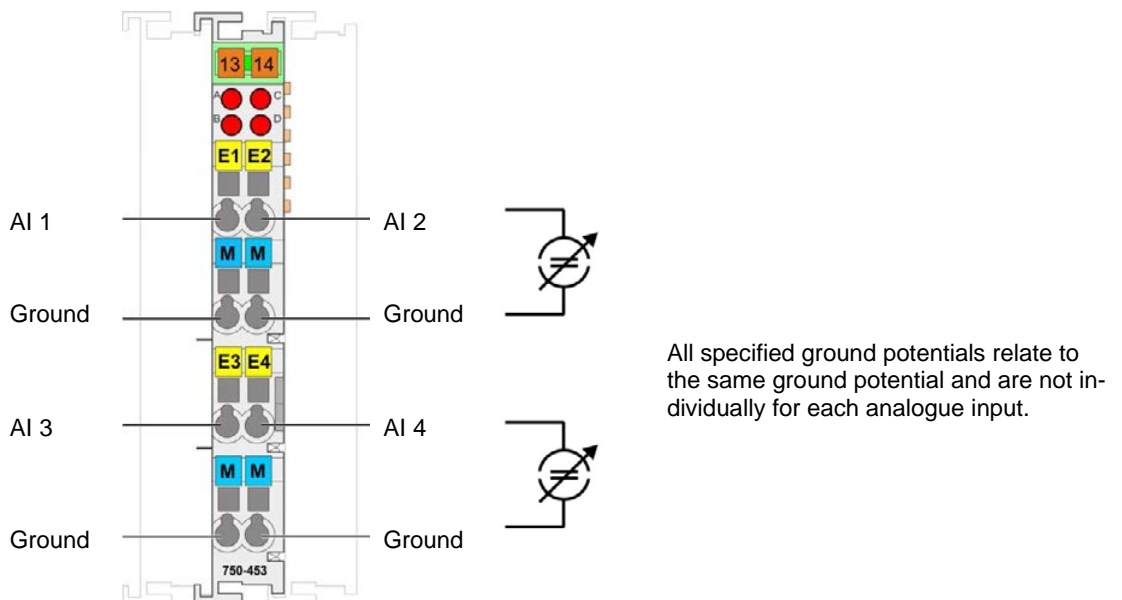
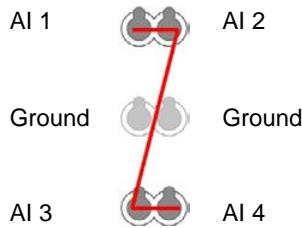


Fig. 8-3 Wiring diagram analogue inputs

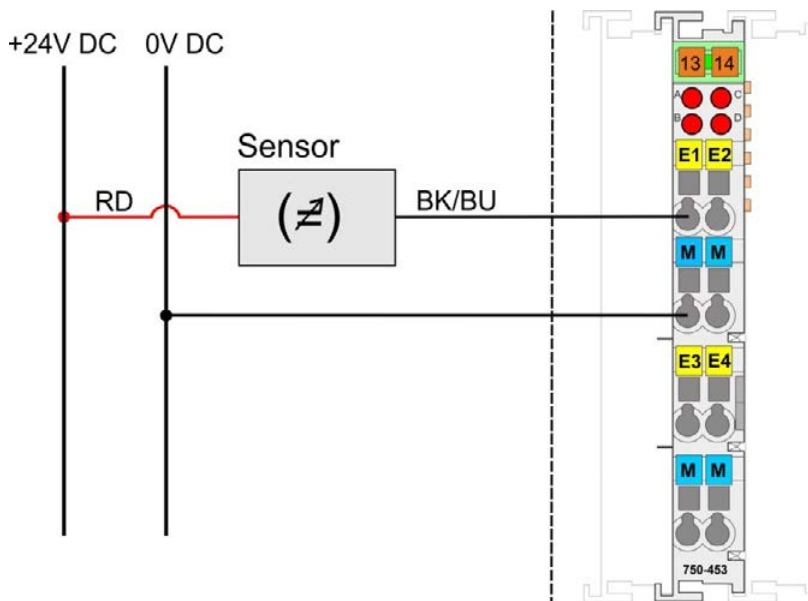
**Observe during installation:**

- Always connect analogue inputs in "Z" shape

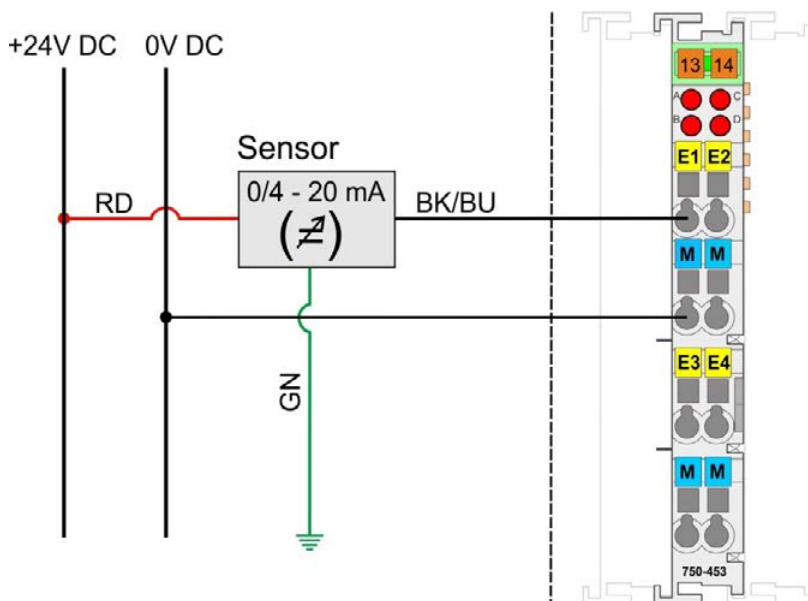


**Fig. 8-4** Connect analogue inputs

**8.5.1.2 Wiring Examples**



**Fig. 8-5** Connecting a 2-wire probe (e.g. pressure probe, i-Sensor) to NLC0CLOG



**Fig. 8-6** Connecting a 3-wire probe to NLC0CLOG

### 8.5.1.3 Screening

#### Common

The use of screened cables reduces electromagnetic influence and hence improves the signal quality. Measurement errors, data transmission errors and errors due to overvoltage can be avoided.



---

**Connect cable screen to ground potential!**

*Consistent screening is absolutely necessary to guarantee technical specifications regarding the measurement accuracy. Connect cable screen and ground potential even at the cable entry of the switching cabinet or the housing. This measure will discharge induced interferences and keeps them away from the installed units.*

---



---

**Improve screening using a large contact area!**

*Screening is improved by using a low-resistance connection between screen and ground potential. To achieve this use a large contact area to connect the screen e.g. by using the WAGO Screen Connection System. This system is recommended particularly for systems with a wide spread with compensating currents flowing or where higher impulse-type currents (e.g. due to atmospheric discharge) may occur.*

---



---

**Keep data and signal lines away from interfering sources!**

*Always lay data and signal lines separated from any high current cables and other sources inducing high electromagnetic emission (e.g. frequency converters or drives).*

---

#### Bus Lines

The screening of the bus line is described in the according installation guidelines and standards of the bus system.

#### Signal Lines

The bus terminals for analogue signals as well as some interface bus terminals are equipped with terminal clamps for screening.



---

**Use screened signal lines!**

*For analogue signals and for bus terminals which are equipped with terminal clamps for screening use exclusively screened signal lines. This is the only way to make sure that the accuracy and interference immunity specified for the according bus terminal are achieved even in case of interferences affecting the signal cable.*

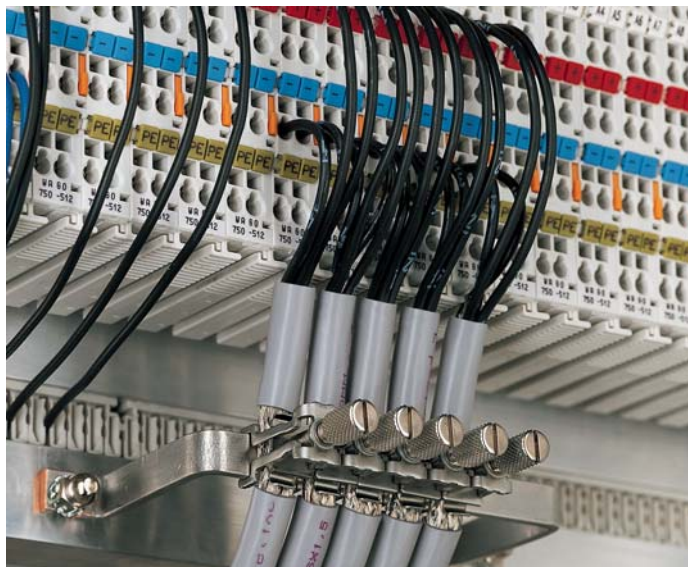
---

### WAGO Screen Connection System

The WAGO Screen Connection System consists of screen spring connections, buses and various mounting bases. These can be used for many different mounting tasks.



**Fig. 8-7** Example WAGO Screen Connection System



**Fig. 8-8** Using the WAGO Screen Connection System

### 8.5.2 Digital Inputs

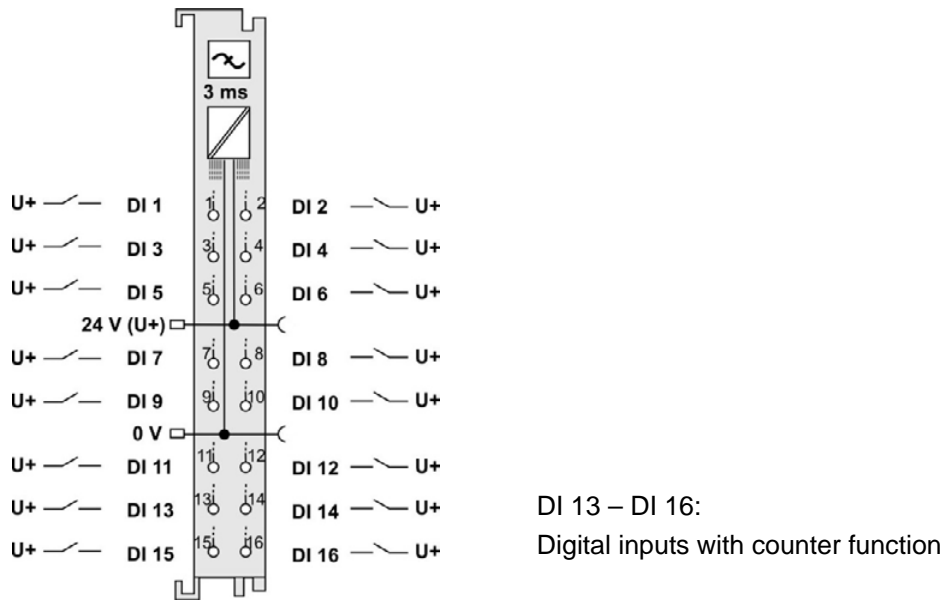


Fig. 8-9 Wiring diagram digital inputs

**Note:** The potential must be the same as that of the field supply voltage.

### 8.5.3 Analogue Outputs

(Only for Art. NLC0CLOGP)

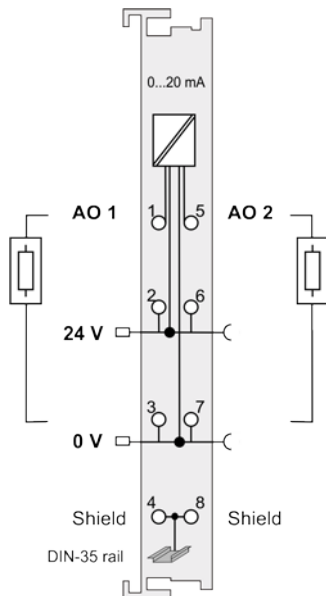


Fig. 8-10 Wiring diagram analogue outputs

### 8.5.4 Digital Outputs

(Only for Art. NLC0CLOGP)

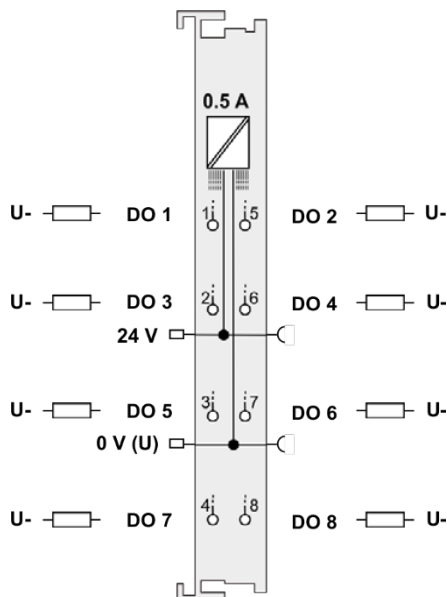


Fig. 8-11 Wiring diagram digital outputs

## 8.6 NLC0CS70

Communication options of the NLC0CS70 device:

Communication Partner	ETHERNET Interface	Configuration
S7 PLC with defined address range in DB100	Port X1	See the following information
Max. 6 NivuFlow transmitters with 1 measuring point each <b>or</b> 3 NivuFlow transmitters with 3 measuring points each	Port X1	NLC see Chap. 11.3 NF see Chap. 11.2
NivuCam	Port X2	None (Plug & Play)

Tab. 8-2 NLC0CS70: Communication Options

⇒ All further information on communication with NivuFlow transmitters see Chap. 11

The settings below are preconfigured and cannot be modified:

Setting		Transmission to NIVUS WebPortal
S7 PLC IP Address:	192.168.1.99	
Data block	DB 100	
32x digital inputs	Byte by byte: DBB0, DBB1, DBB2, DBB3	NIVUS WebPortal divides the transmitted bytes up into bits, i.e. DI00 = DBB0.0; DI01 = DBB0.1; ...
7x measurement values	Word by word: DBW4, DBW6, DBW8, DBW10, DBW12, DBW14, DBW16	Transmission in 0-65535 digits

**Tab. 8-3 NLC0CS70 Default settings**

Set up communication to PLC:

- Via ETHERNET: use network cable and ETHERNET interface X1 on NivuLink Compact. If X1 is occupied use a DIN rail switch.
- **Or** via MPI: use TCP/IP adapter (available from NIVUS upon request).

To set up communication between NLC0CS70 and a S7 PLC the settings below need to be adjusted in TIA portal:

- Deactivate **optimised data block access**.
- Create data block up to at least DB100 DBW16 (see Tab. 8-3). All data points mentioned must be readable even if they are not used.
- Communication with CPU of PLC (no communication component).
- To S7 via TCP/IP (no Profi-Net, select respective ETHERNET-Port).
- Under **Protection & Security > Connection Mechanisms**, allow access via PUT/GET communication by remote partner.

#### **Watchdog function for monitoring of the connection to S7 PLC**

On the S7 PLC the monitoring of the connection is carried out via DB100\_DBB3.7. It is expected that DB100\_DBB3.7 toggles within one minute, i.e. changes the state between 0 and 1 (01010101...). If the status does not change for more than one minute, a connection error to the PLC is reported on the NIVUS WebPortal via Collection 0 Bit 6.

## 8.7 NLC0CNF0

Communication options of the NLC0CNF0 device:

Communication Partner	ETHERNET Interface	Configuration
Max. 6 NivuFlow transmitters with 1 measuring point each <b>or</b> 3 NivuFlow transmitters with 3 measuring points each	Port X1	NLC see Chap. 11.3 NF see Chap. 11.2
NivuCam	Port X2	None (Plug & Play)

Tab. 8-4 NLC0CNF0: Communication Options

⇒ All further information on communication with NivuFlow transmitters see Chap. 11

## 9 Commissioning

### 9.1 Notes to the User



#### **Required documentation**

To put the entire system into operation it may be necessary to additionally consult the instruction manuals of the following accessories as well:

- WAGO Handbooks I/O-System 750

Before connecting and operating the NivuLink Compact the instructions below shall be followed.

This Instruction Manual contains all information required for connecting the NivuLink Compact. The manual is intended for qualified personnel. Appropriate knowledge in the areas of measurement systems, automation technology, control engineering and information technology are preconditions for putting the NivuLink Compact into operation.

Commissioning of the entire measurement system shall not be carried out before installation has been finished and verified. Prior to commissioning it is necessary to familiarise with the instruction manuals.

### 9.2 Switching On the Controller

**Before switching on the controller ensure that you**

- have properly installed the controller (see Chapter 7),
- have connected all required data cables (see section “Connections”) (see chapter 8) to the corresponding interfaces and have secured the connectors by their attached locking screws,
- have connected the electronics and field-side power supply (see chapter 8.4),
- have mounted the bus terminal clamp (NIVUS Art-No. NLC07506000, see Chapter 7.5),



- have performed appropriate potential equalisation at your machine/system (see Chapter 8.4.2) and
- have performed screening properly (see chapter 8.5.1.3).

### Activate Controller and the connected Terminals:

- Activate the power supply on the power adapter.

The power supply LEDs (see Fig. 5-4) indicate the boot sequence. They behave as shown below during a correct system boot sequence:

	LED	Status	Meaning
1.	All	Yellow, flashing briefly	Controller was activated.
2.	SYS	Yellow	Unit is in start-up/boot procedure and the Reset button is not pressed. The <b>e!RUNTIME</b> runtime system is started.
3.	SYS	Green	System start has been executed successfully, unit is ready for operation.
4.	I/O	Green	
5.	RUN	Green	An executable IEC-61131-3 program is saved in the controller which now has been started.

**Tab. 9-1 LED behaviour during boot**

Should there be no executable program available in the controller or if the operation mode switch is set to STOP this will be indicated by RUN-LED as well (see Chapter 5.4).

### 9.3 Network settings

The IP address of the controller is set per default.

To ensure correct communication between host PC and controller over ETHERNET network both components must be within the same subnet.

There are 2 options to achieve this:

#### Option 1 (recommended by NIVUS):

1. Determine the IP address of the host PC (see Chapter 9.3.2).
2. Adjust the IP address of the host PC to the pre-set IP address of the controller if required (see Chapters 9.3.1 and 9.3.3).

#### Option 2:

1. Determine the IP address of the host PC (see Chapter 9.3.2).
2. Adjust the pre-set IP address of the controller to the IP address of the host PC if required (see Chapter 10.4).



#### **Important Note**

*If you change the IP address of the controller, **communication** with S7 PLCs, NivuFlow transmitters and NivuCam is **not possible**.*

#### 9.3.1 IP-Addresses NivuLink Compact and Host PC

##### **NivuLink Compact:**

Per default the ETHERNET interfaces Port X1 and Port X2 of the controllers are set to the addresses below:

Ethernet Interface	Default Setting
X1	192.168.1.111
X2	192.168.3.123

**Tab. 9-2 Pre-set IP address of Ethernet interfaces**

**Note:** the ETHERNET interface Port X2 is intended to connect the NivuCam (applies for all device versions except NLC0CLOGS). The NivuCam operates via the ETHERNET interface Port X2 Plug & Play.

##### **Host PC:**

The default IP address of the controller is 192.168.1.111, the host PC must be within the same subnet. Therefore, in the network mask 255.255.255.0 the first 3 digits of the host PC must be the same as with the controller while the last digits must be different. This results in the following address space for the host PC:

IP Address Controller	Subnet Address Space for the Host PC
192.168.1.111	192.168.1.00 ... 192.168.1.254 except 192.168.1.111

**Tab. 9-3 Network mask 255.255.255.0: IP addressing of host PC**

### 9.3.2 Determine IP Address of the Host PC

In order to get access to the controller it is necessary to determine the IP address of the host PC. The procedure required for the Microsoft Windows® operating system is described below.

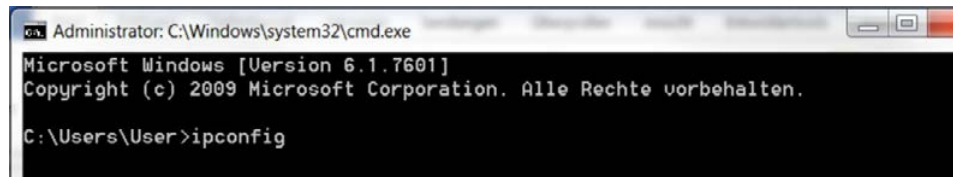
#### Procedure:

1. Call up prompt:
  - a) Type "cmd" into the search box of the task bar.



- b) Confirm with **[Enter]**.  
→ The prompt opens.
2. Determine IP address of the host PC:

- a) Type command "ipconfig" and confirm with **[Enter]**.



- The Windows IP configuration is shown
- b) Scroll to group "Ethernet Adapter LAN Connection"



- IP address of the host PC, subnet mask and the standard gateway as well as the according parameters are indicated.
3. Close prompt.

#### Next Step:

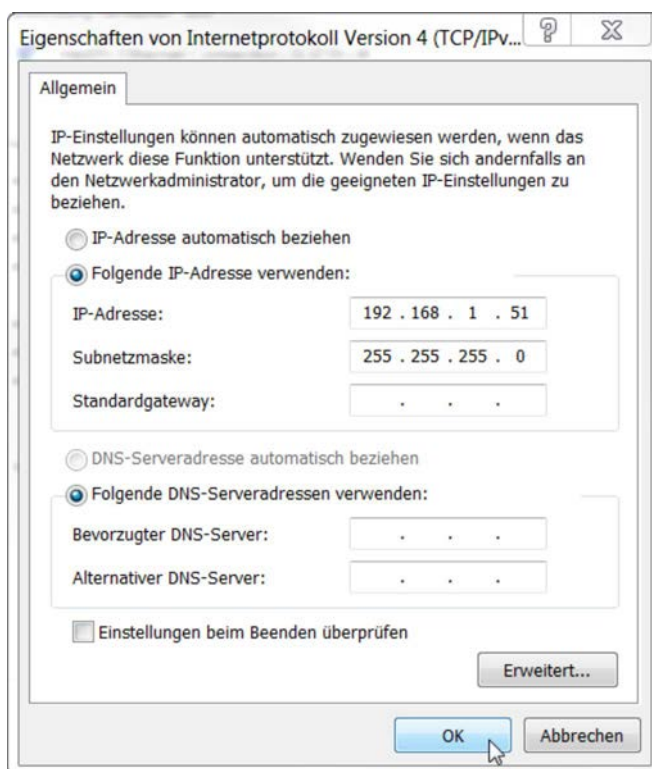
- Adjust the IP address of the host PC if necessary.

### 9.3.3 Adjusting the IP Address of the Host PC

The following procedure describes how to adjust the IP address of the host PC to the IP address of the controller in the Microsoft Windows® operating system.

#### Procedure:

1. Left-click the Windows icon in the bottom left corner of the screen.  
→ The Windows start menu opens.
2. Open *Control Panel > Network and Internet > Network and Sharing Centre*
3. **Select Change Adapter Settings.**  
→ The network connections are called up.
4. Right-click to select the network connection.  
→ The context menu opens.
5. Select **Properties.**  
→ The connection properties are shown.
6. Double-click to select **Internet Protocol Version 4 (TCP/IPv4).**  
→ The Internet Protocol Version 4 (TCP/IPv4) properties are opened.



7. Enable **Use the following IP Address.**
8. Type "192.198.1. xxx" as new IP address of the host PC into the **IP Address** input box.
9. Type "255.255.255.0" into the **Subnet Mask** input box
10. Click **OK**.  
→ Internet Protocol Version 4 (TCP/IPv4) properties are closed.
11. In the connection properties window click **OK**.  
→ Connection properties are closed.  
→ The IP address of the host PC is now changed.

## 9.4 Deactivate / Restart Controller

### Deactivate Controller:

- Power supply:Deactivate.

### Restart Controller:

1. Set the mode switch to RUN or STOP.
2. Press the Reset key (RST) longer than 1 second but less than 8 seconds.  
→ Correct execution is indicated by all LEDs flashing green briefly.

Or

1. Deactivate the controller (switch off power supply).
2. Restart controller.

## 9.5 Reset Functions

Use the mode selector switch to trigger different reset functions.

⇒ Position mode selector switch see *Fig. 5-1*

⇒ Description mode selector switch see chapter 5.5

### 9.5.1 Warm Start Reset

#### ***e!RUNTIME Runtime System***

All *e!RUNTIME* applications are reset with a warm start reset. All global data is set to its initialisation values.

#### **Execute Warm Start Reset:**

1. Move the mode selector switch to reset position and hold it there for longer than 2 seconds but less than 7 seconds.
2. Let the mode selector switch go.  
→ Execution is indicated by the red "RUN" LED going off briefly.

### 9.5.2 Cold Start Reset

#### ***e!RUNTIME Runtime System***

Cold start reset will reset all *e!RUNTIME* applications. All global data as well as the retain-variables will be reset to initialisation values.

#### **Execute Cold Start Reset:**

1. Move the mode selector switch to reset position and hold it there for longer than 7 seconds.  
→ After 7 seconds execution is indicated by the red "RUN" LED going off longer.
2. Let the mode selector switch go.

## 10 Configuration via Web Based Management (WBM)

Web-Based Management (WBM) serves to configure the controller. You can access the WBM using an Internet browser.

NIVUS recommend using Google Chrome.

In the following sections you can find any relevant information for the commissioning of the NivuLink Compact by using WBM.

### 10.1 Basic Instructions

**Should cookies be deactivated in your browser observe the information below:**

You can continue using WBM as long as you move directly within. Once you should reload the website completely (e.g. using F5) the browser has no possibility to save the data of your log-in session. In such a case you need to log in again.

**Observe when executing a CODESYS program:**

Once the controller is busy due to a CODESYS program processing within WBM may slow down. This is why possibly time-out errors may be reported. Therefore, it makes sense to stop the CODESYS application prior to beginning comprehensive configuration works using WBM.

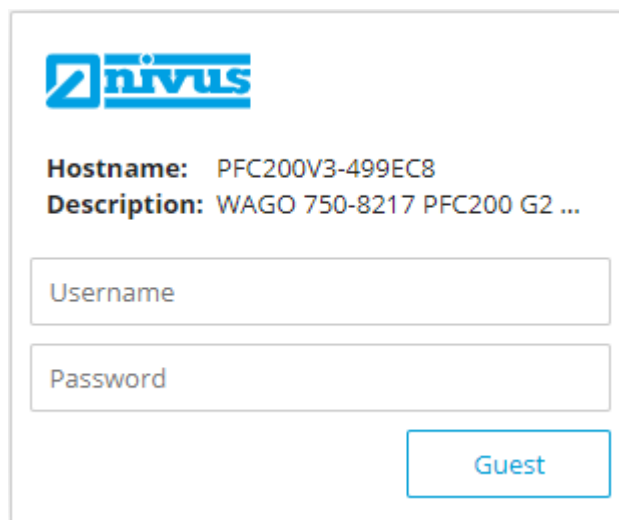
## 10.2 Call Up WBM

### Prerequisite:

- The controller is active (see Chapter 9.2).

### Procedure:

1. Connect the controller to your PC and the ETHERNET network by using ETHERNET interface X1.  
If X1 is occupied (e. g. for NF or DSL router): use a DIN rail switch.
2. Open Internet browser on the PC (recommended: Google Chrome).
3. Type <https://192.168.1.111/> into address line and confirm with **[Enter]**.  
→ If the connection to the controller could be established, then the login window of the WBM opens.

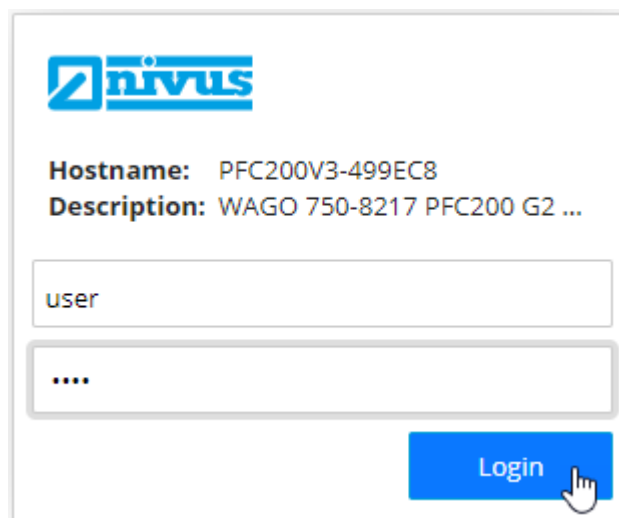


**Username**

**Password**

Guest

4. In the **User name** input field enter "user".
5. In the **Password** input field type in "2718" as password.
6. Click Login.



**user**

....

Login

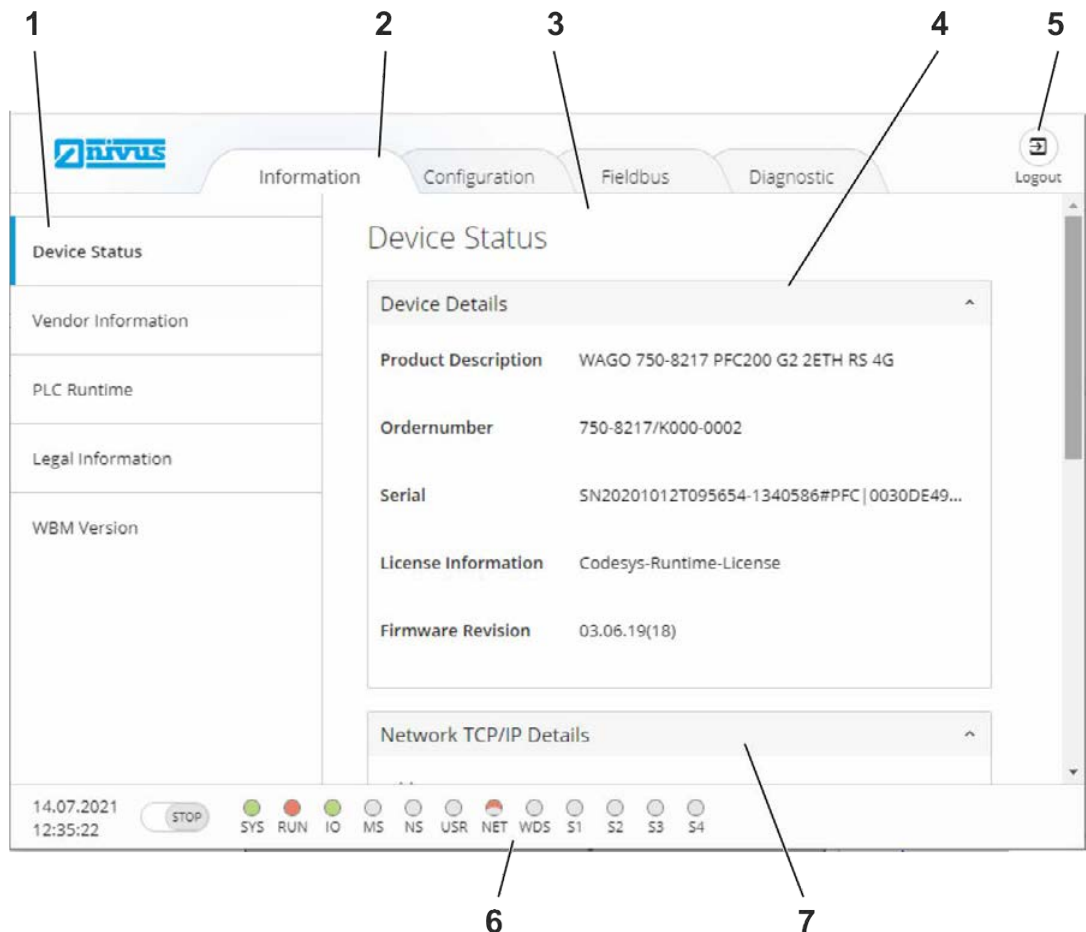
- The WBM is called up. The range of functions depends on your user authorisations.

### If WBM should not start:

- Make sure that your Internet browser settings enable to bypass the proxy server for local addresses.
- Verify whether your PC is within the same subnet as the controller.

## 10.3 WBM Start Screen

The figure below gives an example on the layout of the WBM browser screen.



- 1 Navigation: here all entries and sub-entries of the chosen tab (2) can be selected if required. Entry highlighted blue: selected, entry is shown in information area (3).
- 2 Tabs
- 3 Information Area
- 4 Device Information
- 5 Logout
- 6 Status area: indicates connection and device status
- 7 Connection Information

**Fig. 10-1 WBM start screen**



## 10.4 Change IP-Address of the NivuLink Compact

You can change the pre-set IP address of the NivuLink Compact to that of your existing network if required. In such a case assign a new IP address to the X1 ETHERNET interface.



### Important Note

If you change the IP address of the controller, **communication** with S7 PLCs, NivuFlow transmitters and NivuCam is **not possible**.

### Prerequisites:

- WBM is called up and the connection to the controller is established (see Chapter 10.2).
- You are logged in with WBM.

### Procedure:

1. Open the **Configuration** tab
2. In the navigation select **Networking > TCP/IP Configuration**  
→ The TCP/IP configuration opens. You can find the IP address of ETHERNET interface X1 under **Network Details Bridge 1 (br0)**.
3. Change the IP address in the **Static IP Address** input field.
4. Use **Submit** or **[Enter]** to confirm.  
→ A new IP address is assigned to the X1 ETHERNET interface of the controller.

## 11 Communication with NivuFlow Transmitters

You can use all NLC devices for communication with NivuFlow transmitters. The maximum possible extent of use is optionally

- 3 NivuFlow transmitters with 3 measuring points each
- or 6 NivuFlow transmitters with 1 measuring point each

The values below are transmitted:

- Flow
- Level
- Flow Velocity
- Water Temperature
- Air temperature

Set up communication to NivuFlow:

- Via ETHERNET: use network cable and ETHERNET interface X1 on NivuLink Compact. If X1 is occupied use a DIN rail switch.

In addition, you must configure the following for communication:

- On each NivuFlow: IP address (see Chap. 11.2)
- On NivuLink Compact in the web visualisation: extent of connected NivuFlow transmitters and measuring points (see Chap. 11.3)

You can find more information on this in the following sections.

### 11.1 Default Settings on NivuLink Compact

The settings below are preconfigured and cannot be modified:

	IP Address NivuFlow	Modbus Port
NivuFlow 1	192.168.1.11	502
NivuFlow 2	192.168.1.12	502
NivuFlow 3	192.168.1.13	502
NivuFlow 4	192.168.1.14	502
NivuFlow 5	192.168.1.15	502
NivuFlow 6	192.168.1.16	502

Tab. 11-1 NivuLink Compact: Default settings for NivuFlow transmitters

## 11.2 Setting Parameters NivuFlow

Set the TCP/IP parameters on the NivuFlow transmitters 1 - 6 as follows (for example, see the following illustration):

Device	IP Address	Subnet Mask	Gateway	DNS primary	DNS secondary
NivuFlow 1	192.168.1.11	255.255.255.0	192.168.1.111	192.168.1.111	192.168.1.111
NivuFlow 2	192.168.1.12	255.255.255.0	192.168.1.111	192.168.1.111	192.168.1.111
NivuFlow 3	192.168.1.13	255.255.255.0	192.168.1.111	192.168.1.111	192.168.1.111
NivuFlow 4	192.168.1.14	255.255.255.0	192.168.1.111	192.168.1.111	192.168.1.111
NivuFlow 5	192.168.1.15	255.255.255.0	192.168.1.111	192.168.1.111	192.168.1.111
NivuFlow 6	192.168.1.16	255.255.255.0	192.168.1.111	192.168.1.111	192.168.1.111

Tab. 11-2 Parameter settings NivuFlow transmitters for NLC0CNF0

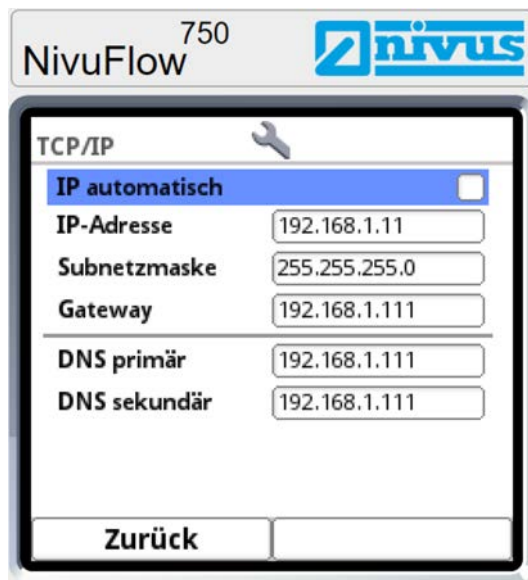


Fig. 11-1 TCP/IP settings in NivuFlow transmitter 1

## 11.3 Configuration NivuLink Compact: Web Visualisation

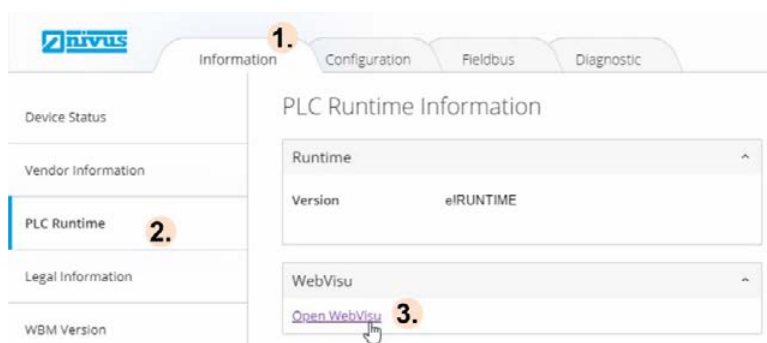
### 11.3.1 Call up the Web Visualisation

**Prerequisites:**

- The controller is active (see Chapter 9.2).
- The controller is connected to your PC via ETHERNET interface X1 and the ETHERNET network.

You have 2 possibilities to call up the web visualisation of an NLC device.

**Option 1: Call up web visualisation in WBM**

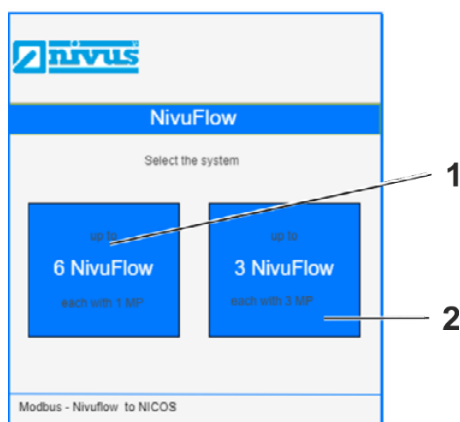


1. In the **Web Based Management (WBM)** open the **Information** tab
  2. Select **PLC Runtime**
  3. Click > **WebVisu** > **Open WebVisu**
- The web visualisation opens in a new browser tab.

**Option 2: Call up web visualisation directly in the Internet browser**

- Enter the following URL in the address bar: *https://[IP address of the controller]/webvisu* (instead of *https* you can use *http* alternatively)

### 11.3.2 Start Screen of the Web Visualisation



- 1 Opens the configuration view for the use of 6 NivuFlow transmitters
- 2 Opens the configuration view for the use of 3 NivuFlow transmitters

**Fig. 11-2 Start screen of the NLC web visualisation**

## 11.3.3 Login

The configuration in the web visualisation is only enabled for logged-in users.

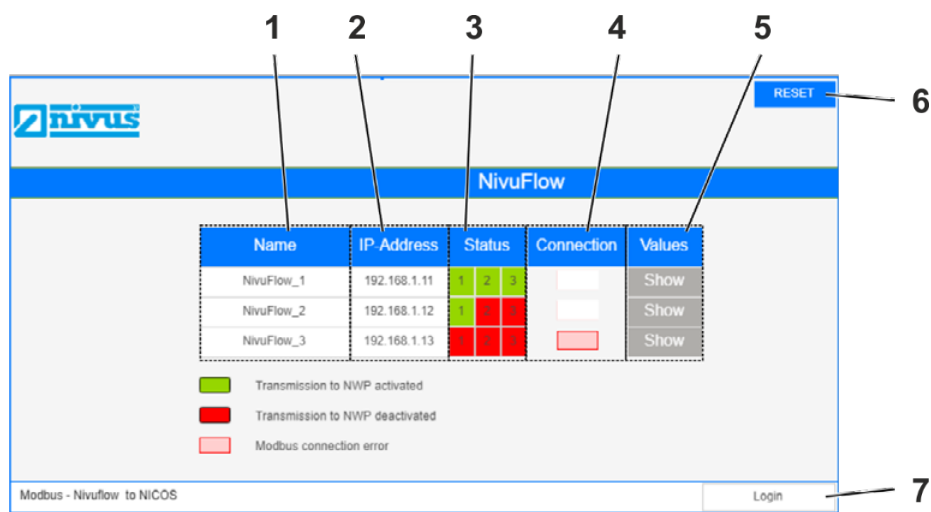
You can log in to the web visualisation with the following data:

- User name: **Service**
- Password: **2718**

## 11.3.4 Configuration View of the Web Visualisation

### Overview

The following illustration shows the configuration view for 3 NivuFlow transmitters. The configuration view for 6 NivuFlow transmitters is structured analogously.



- 1 Name of the NivuFlow transmitter
- 2 IP address of the NivuFlow transmitter, preconfigured and not changeable  
Setting parameters on NivuFlow see Chapter 11.2
- 3 Connection status NivuLink Compact – Nivus WebPortal  
Green = connected, i. e.. should the NLC receive data from the NivuFlow, these data will be forwarded to the NIVUS WebPortal.  
Red = no connection
- 4 Connection Status NivuLink Compact – NivuFlow  
White = connected  
Red = no connection
- 5 **Show**: Opens the unit information with the current measurement data, provided there is a connection to the NivuFlow
- 6 Resets the configuration, i.e. all connections between NLC and NIVUS WebPortal are disconnected
- 7 Opens the login mask

**Fig. 11-3 Configuration view for 3 NivuFlow transmitters**

### Operation

Action	Execution
Unlock configuration	Click <input type="button" value="Login"/> and log in with user name <b>Service</b> and password <b>2718</b>
Change connection status from NLC to the NIVUS WebPortal	Click on <span style="color: red;">■</span> or on <span style="color: green;">■</span> in the <b>Status</b> column at the desired device and, if applicable, at the desired measuring point
Save the modifications	Not necessary, automatic storage
Call up current device values	Click <input type="button" value="Show"/>
Shift configuration view from 3 NF to 6 NF or vice versa	Close the browser tab and re-open the web visualisation
Reset all connections between NLC and NIVUS WebPortal (= disconnect)	Click <input type="button" value="Reset"/>
Finish web visualisation	Close the browser tab



#### **Important Note**

*Data transmission from the NivuFlow to the NIVUS WebPortal is only possible if there is a connection between the NivuLink Compact and the NIVUS WebPortal as well as between the NivuLink Compact and the NivuFlow.*

### 11.3.5 Configure the NLC for the Use of NivuFlow Transmitters

#### **Procedure:**

1. To call up the web visualisation see Chap. 11.3.1  
→ The start screen opens
2. Select the desired option: **3 NivuFlow** or **6 NivuFlow**  
→ The configuration view opens.
3. Log in:
  - c) Click
  - The login mask opens
  - d) Enter the user name **Service**
  - e) Enter the password **2718**
  - f) Confirm with
  - The configuration is enabled.
4. To establish a connection to the NIVUS WebPortal for all desired NivuFlow transmitters and measuring points, click on ■ in the **Status** column  
→ The connection is established, the connection status is ■.
5. To finish the web visualisation close the browser-tab

## 12 NIVUS WebPortal

NIVUS WebPortal is a data management system for storage and provision of measurement data. The measured data are transmitted from NivuLink Compact to the NIVUS WebPortal as standard.

This chapter provides all relevant information required to successfully operate the NivuLink Compact (NLC) in combination with the NIVUS WebPortal.



---

*You can find more information in the NIVUS WebPortal handbook.*


---

### 12.1 Basic Information

**Call up NIVUS WebPortal:** <https://www.nivuswebportal.com/>

**Access data:** Once your project has been created you will receive your access data (user name and password) to the NIVUS WebPortal by e-mail.

#### Download NIVUS WebPortal Handbook:

1. Call up the NIVUS WebPortal
2. Log in to NIVUS WebPortal
3. In the menu bar top right click 



→ The NIVUS WebPortal handbook is saved in the download directory of your browser.

### 12.2 Verify Connection to NIVUS WebPortal

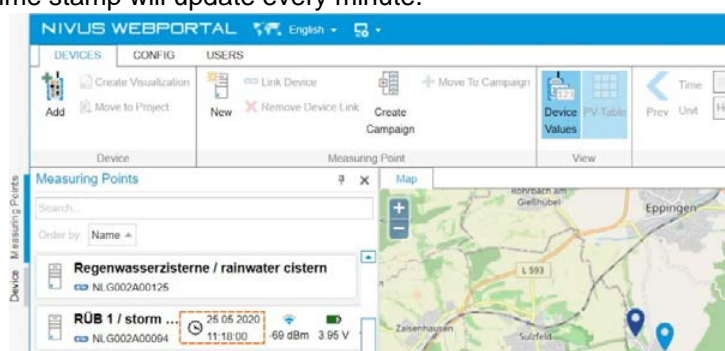
The USR-LED on the NivuLink Compact indicates the status of the connection to the NIVUS WebPortal (see Chap. 5.4.8). The procedure below describes how to determine the connection status in the NIVUS WebPortal.

**Prerequisites:**

- Mobile phone connection is available.
- The SIM card of the NLC is activated.
- An according project is created in the NIVUS WebPortal.

**Procedure:**

1. Call NIVUS WebPortal: type <https://www.nivuswebportal.com/> into the address field of your Internet browser.
  - The start screen of the NIVUS WebPortal is shown.
2. Enter user name and password.
3. Click **Login**
  - This opens the main screen of the NIVUS WebPortal.
  - The connection status of the respective device can be seen from the measuring point overview or from the device overview: the NLC transmits every minute. If the connection between NLC and the NIVUS WebPortal has established the NLC time stamp will update every minute.



### 12.3 Process Variables

Process variables (PV) present the process status in the NIVUS WebPortal. Each process variable represents a process parameter (e.g. filling level). The process variable's value is the process value.

The process variables of the NivuLink Compact are pre-configured for your application per default.

Process variables can be edited. The following sections provide an overview on the configuration options and the basic procedures.



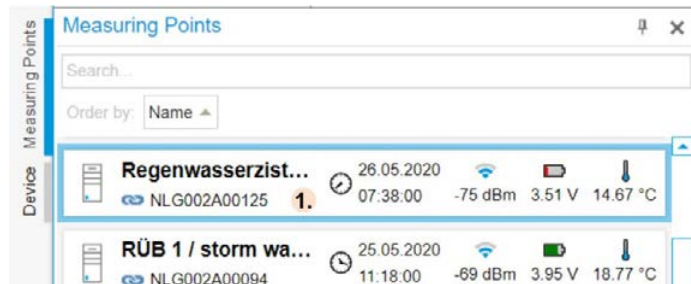
### 12.3.1 Edit Process Variable

#### Prerequisite:

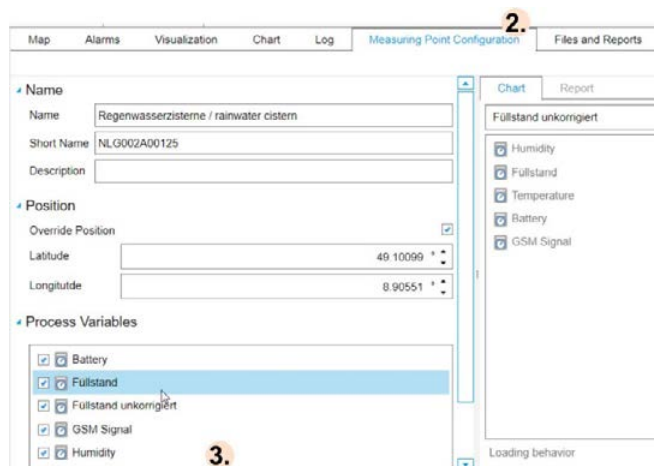
- The NIVUS WebPortal is open and you are logged in as administrator.
- Connection between NLC and NIVUS WebPortal is established.


#### Procedure:

1. In measurement point overview select the measurement point linked with the NLC.
  - Measuring point is highlighted (blue frame).
  - In the workspace all available views are indicated as tabs.




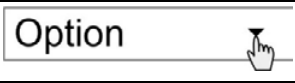


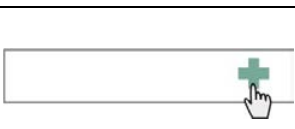


2. In the workspace select the > **Measuring Point Configuration** view.
  - The NLC measuring point configuration is shown in the workspace.
  - In the **Process Variables** group all process variables created for the selected measuring point are shown.



3. Select process variable.
  - The window **Edit Process Variable** is opened.
4. Edit the process variable, configuration options see Chapter 12.3.2
5. Click **Close**.
  - Window is closing, changes have not yet been saved.
6. Click .
  - The changes will be saved.

### 12.3.2 Configuration Options or Process Variables

The configuration options shown in the **Edit Process Variable** window depend on the type of process variable(s). The table below gives an overview on the entry options.

Representation	Function	Entry
	Input field	Enter free text
	Opens a dropdown list	Select option from list
	Opens the calendar	Open calendar, then select date and time <b>or</b> select and overwrite value
	Numeric field	Step value up or down using the arrow keys <b>or</b> select and overwrite
	Opens a selection window	Select option
	Opens a configuration window	Configure value, e.g. limit value
	Deletes selected option	
	Checkbox	Activate or deactivate

Tab. 12-1 NIVUS WebPortal: overview on options to edit process variables

## 13 Accessories and Extensions

### 13.1 NIVUS Accessories and Extensions

The following accessories and extensions can be purchased from NIVUS.

#### Accessories:

Art.-No.	Description
NLC075808790	SD memory card for NivuLink Control, 2 GB
ZUB0ANT01	Antenna GSM & GPRS & LTE, omni-directional, SMA male, bendable
ZUB0ANT02	Round antenna GSM/LTE, for installation in dirt pan or mounting on control cabinets or similar, connection cable 2.5 m, SMA male
ZUB0ANT03	Magnetic base antenna, 4G, cable length 2.5m RG 174, connection SMA plug, 2dBi, antenna length approx. 10cm, preferred antenna for devices: NFX series flow meters; Hybrid N75; Energy Saver NR7; NivuParQ NP8 particle concentration measurement
ZUB0ANT04	Station antenna with rod holder for outside installation, GSM/UMTS/WLAN/LTE antenna, 5 m, LowLoss, SMA plug, rod approx. 193 mm, incl. mounting angle
NLF0KOMBIUSV	Combi UPS switching power adapter 24 V DC / 5 A; AC converter 230 V AC to 24 V DC
NLF0USVAKKU12	Maintenance-free rechargeable lead gel battery 24 / 1.2 Ah for combi UPS switching power adapter
NLF0USVAKKU32	Maintenance-free rechargeable lead gel battery 24 / 3.2 Ah for combi UPS switching power adapter

Tab. 13-1 NIVUS accessories

#### Extensions:

Art.-No.	Description
NLC07504530	Analogue input clamp 4-channel, 0-20 mA
NLC07501405	Digital input clamp 16-channel digital input, 24 V DC, 3 ms
NLC07505520	Analogue output clamp 2-channel, 0-20 mA, 24 V DC
NLC07505300	Digital output clamp 8-channel, 0.5 A, 24 V DC
NLC07506000	Bus terminal clamp

Tab. 13-2 NIVUS extensions

Additional extensions upon request.

## 13.2 WAGO Accessories

The following accessories can be purchased from WAGO.

**WAGO Kontakttechnik GmbH & Co. KG**

Phone: +49 571 887 4433

[orderservice.de@wago.com](mailto:orderservice.de@wago.com)

### End Stops:

Order-No.	Description
249-116	End stop for DIN 35 rail, 6 mm wide
249-117	End stop for DIN 35 rail, 10 mm wide

Tab. 13-3 WAGO accessories: End stops

### Carrier Rails:

Order-No.	Description
210-112	Carrier rail 35 × 7.5; 1 mm; steel; bluish, tinned, chromed; slotted
210-113	Carrier rail 35 × 7.5; 1 mm; steel; bluish, tinned, chromed; without slot
210-197	Carrier rail 35 × 15; 1.5 mm; steel; bluish, tinned, chromed; slotted
210-114	Carrier rail 35 × 15; 1.5 mm; steel; bluish, tinned, chromed; without slot
210-118	Carrier rail 35 × 15; 2.3 mm; steel; bluish, tinned, chromed; without slot
210-198	Carrier rail 35 × 15; 2.3 mm; copper; without slot
210-196	Carrier rail 35 × 8.2; 1.6 mm; aluminium; without slot

Tab. 13-4 WAGO accessories: Carrier rails

### Filter Modules for 24 V Supply:

Order-No.	Name	Description
750-626	Supply Filter	Filter module for system supply and field supply (24 V, 0 V), i. e. for fieldbus coupler/controller and bus power supply (750-613)
750-624	Supply Filter	Filter module for the 24 V field supply (750-602, 750-601, 750-610)

Tab. 13-5 WAGO accessories: filter modules

### 14 Maintenance and Cleaning

---

#### WARNING



#### ***Danger of electric shock***

- *Disconnect the instrument from mains power before you begin maintenance, cleaning and/or repair works (qualified personnel only).*
- 

#### 14.1 Maintenance Interval

The NivuLink Compact is conceived to be virtually free of calibration, maintenance and wear. Nevertheless, NIVUS recommend an **annual check** of the device by the NIVUS customer service. This check includes firmware updates, if new updates are available.

In addition to annual maintenance NIVUS recommend having the measurement system completely be inspected by a member company of the NIVUS group after **10 years the latest**.

Generally the system inspection is a basic measure that contributes to improve operational reliability and to increase the lifetime.

#### 14.2 Cleaning

---

#### CAUTION



#### ***Risk of equipment damage***

*due to improper cleaning.*

- *Clean enclosure and dirty contacts with propanol.*
  - *Do not use contact spray since the spray may impair contact area functionality in connection with contamination.*
- 

#### 14.3 Customer Service Information

For the recommended annual inspection of the entire measurement system and/or the extensive inspection after latest 10 years contact our customer service:

#### **NIVUS GmbH – Customer Service**

Phone +49 7262 9191-922

[customercenter@nivus.com](mailto:customercenter@nivus.com)

### 15 Dismantling

**CAUTION**



**Risk of personal injury**

through sharp-edged blade contacts.

- Handle input terminals and bus terminal clamps carefully.

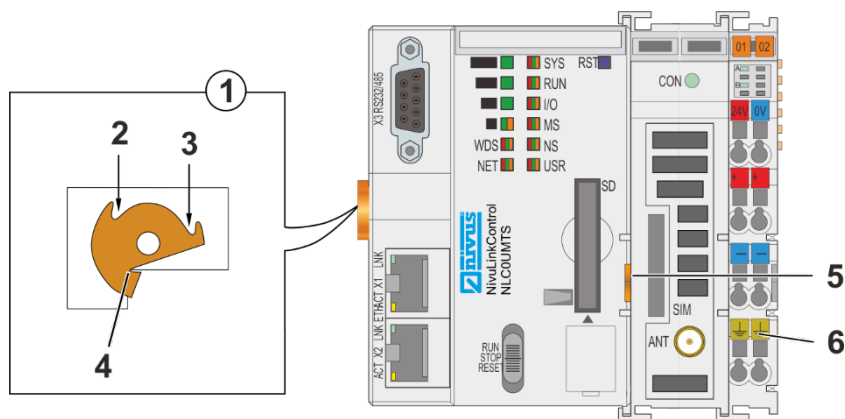
**CAUTION**



**Risk of equipment damage**

due to working on live systems.

- Disconnect equipment from mains power prior to working on the devices.



- 1 Top view locking disc
- 2 Fix lock
- 3 Release lock
- 4 Nose of locking disc
- 5 Releasing strap
- 6 Feed-in section (fixed component of controller, cannot be removed)

**Fig. 15-1 Locking the controller**

**Removing the controller:**

1. Rotate the locking disc using a screwdriver blade until the nose of the locking is no longer latched behind the carrier rail.
2. Use the releasing strap to pull the controller out of the array.
  - By pulling the controller out the electrical connections between data contacts or power contacts and the following input terminals are disconnected again.



**Important Note**

The feed-in section (Fig. 15-1, Pos. 6) is a fixed component of the controller. The enclosure components are firmly connected to each other.

- Do not separate enclosure components from each other.

---

## 16 Disposal

Improper disposal may be harmful to the environment.

Always dispose equipment components and packaging materials according to applicable local regulations on environmental standards for electronic products.



### **EU WEEE Directive**

*This symbol indicates that the requirements of Directive 2012/19/EU on waste electrical and electronic equipment must be observed when disposing of the device. Die NIVUS GmbH support and promote the recycling or environmentally sound, separate collection/disposal of waste electrical and electronic equipment to protect the environments and human health. Observe the local laws and regulations on disposal.*

*NIVUS GmbH is registered with the EAR, therefore public collection and return points in Germany can be used for disposal.*

---

### Index

<b>A</b>	Accessories .....75, 76	<b>I</b>	Installation .....46
	Analogue input clamp.....20, 28		Intended Use .....16
	Analogue output clamp.....20, 29		IP Address
<b>B</b>			Host PC .....58, 59, 60
	Bus terminal clamp.....20		NivuLink Compact..... 58, 65
<b>C</b>		<b>L</b>	
	CAGE CLAMP® connection.....47		LED Indication
	Colour Codes Wire Identification..... 10		Connection status communication hub ... 26
	Commissioning .....56		Fieldbus/System ..... 23
	Communication		Internal data bus status..... 26
	NivuFlow ..... 66		Module status..... 26
	S7 SPS ..... 55		Network status ..... 24
	Controller		PLC Program Status ..... 25
	Deactivate ..... 61		Status..... 23
	Dismantling ..... 78		System status ..... 25
	Lock ..... 45, 78		LED-Indication
	Mounting ..... 45		Data service status ..... 24
	Restart ..... 61		Web-Based Management ..... 64
	Switching on..... 56	<b>M</b>	
	Copyright .....3		Maintenance .....77
	Copyrights and Property Rights .....3		Mode selector switch.....27
	Customer Service.....77		Mounting
<b>D</b>			Controller ..... 45
	Device Versions .....19		Installation position ..... 38
	Digital input clamp .....20, 28		Onto carrier rail ..... 42
	Digital output clamp.....20, 29		Sequence..... 44
	Dimensions.....38		Spacing..... 43
	Analogue input clamp..... 30		Terminals ..... 44
	Analogue output clamp ..... 30	<b>N</b>	
	Controller ..... 30		Names .....3
	Digital input clamp..... 30		Network settings.....58
	Digital output clamp..... 31		NivuFlow
	Disclaimer.....12		Setting up communication..... 66
	Dismantling.....78		NivuLink Compact, Overview .....20
	Disposal.....79		NIVUS WebPortal.....71
	Duties of the Operator .....16		Access Data..... 71
<b>E</b>			Call Up ..... 71
	Equipotential bonding.....49		Download handbook ..... 71
	ETHERNET Interfaces .....65		Process Variables ..... 72
	EU Declarations of Conformity .....82		Verify Connection..... 72
	Extensions .....75	<b>P</b>	
<b>F</b>			Power Supply Concept .....48
	Firmware Update .....77		Precautions.....14
<b>H</b>			Product Specification.....19
	Hotline .....12		Protection of the Electronics Power
			Supply.....48



<b>R</b>			
	Requirements for the Personnel .....	17	
	Reset function		
	Cold Start .....	61	
	Warm Start .....	61	
	Reset Function .....	61	
	Return .....	19	
<b>S</b>			
	S7 PLC		
	Set up communication .....	55	
	Watchdog function .....	55	
	S7 SPS		
	Settings in TIA portal .....	55	
	Scope of Delivery .....	18	
	Screening .....	51	
	Bus line .....	51	
	Signal lines .....	51	
	Security Measures .....	14	
	Specifications .....	30	
	Storage .....	18	
	Support .....	12	
<b>T</b>			
	Technical data		
	Analogue input clamp .....	34	
	Analogue output clamp .....	36	
	Clock .....	32	
	Device data .....	30	
	Digital input clamp .....	35	
	Digital output clamp .....	37	
	Environmental conditions .....	33	
	ETHERNET .....	32	
	Field wiring .....	33	
	Mobile phone modem .....	33	
	Power supply .....	31	
	System data .....	31	
	Terminal - Mounting .....	44	
	Translation .....	3	
	Transport .....	19	
	<b>U</b>		
	UK Declarations of Conformity .....	82	
	<b>W</b>		
	Warranty .....	11	
	Web Based Management .....	62	
	Call up .....	63	
	Start screen .....	64	
	Web visualisation .....	68	
	Web visualisation		
	Calling up .....	68	
	Password .....	69	
	User name .....	69	
	Wiring diagram		
	Analogue inputs .....	49	
	Analogue outputs .....	53	
	Digital inputs .....	53	
	Digital outputs .....	54	

## EU Declarations of Conformity and UK Declarations of Conformity

The EU Declarations of Conformity and the UK Declarations of Conformity in this chapter apply to the NivuLink Compact product family.

Devices, extensions and accessories of the NivuLink Compact family are produced by WAGO Kontakttechnik GmbH & Co. KG, Minden.

The tables below assign the NIVUS article numbers to the according WAGO article numbers.

NIVUS Art.-No.	NIVUS Name	WAGO Art.-No.
NLC0CLOGE0	NivuLink Compact Log	Main component Art. 750-8217
NLC0CLOGEG	NivuLink Compact Log	
NLC0CLOGPE0	NivuLink Compact Plus	
NLC0CLOGPEG	NivuLink Compact Plus	
NLC0CLOGSE0	NivuLink Compact Small	
NLC0CLOGSEG	NivuLink Compact Small	
NLC0CS70E0	NivuLink Compact S7	
NLC0CS70EG	NivuLink Compact S7	
NLC0CNF0E0	NivuLink Compact NF	
NLC0CNF0EG	NivuLink Compact NF	

Tab. 16-1 Assignment NivuLink Compact (Controller) – WAGO Article Number

NIVUS Art.-No.	NIVUS Name	WAGO Art.-No.	NLC0CLOGE0	NLC0CLOGEG	NLC0CLOGPE0	NLC0CLOGPEG	NLC0CLOGSE0	NLC0CLOGSEG	NLC0CS70E0	NLC0CS70EG	NLC0CNF0E0	NLC0CNF0EG
			NLC07504530	Analogue input clamp 4-channel, 0-20 mA	750-0453	x	x	x	x	x	x	
NLC07501405	Digital input clamp 16-channel digital input, 24 V DC, 3 ms	750-1405	x	x	x	x	x	x				
NLC07505520	Analogue output clamp 2-channel, 0-20 mA, 24 V DC	750-552			x	x						
NLC07505300	Digital output clamp 8-channel, 0.5 A, 24 V DC	750-530			x	x						
NLC07506000	Bus terminal clamp	750-600	x	x	x	x	x	x	x	x	x	x
NLC07588790	SD memory card for NivuLink Control, 2 GB	758-0879/0000-0001	x	x	x	x	x	x	x	x	x	x

Tab. 16-2 Overview on WAGO components in NivuLink Compact units

**EU-Konformitätserklärung**  
**EU-Declaration of Conformity**



<b>Artikelnummer:</b> Item number:	<b>750-8217/K000-002</b> <b>0750-8217/K000-0002</b>
<b>Produktbezeichnung:</b> Product designation:	<b>Controller PFC200</b> <b>Controller PFC200</b>

Hersteller / Manufacturer: WAGO Kontakttechnik GmbH & Co. KG  
Hansastraße 27  
32423 Minden  
Germany  
www.wago.com

Die alleinige Verantwortung für die Ausstellung dieser Konformitätserklärung trägt der Hersteller.  
This declaration of conformity is issued under the sole responsibility of the manufacturer.  
Der oben genannte Gegenstand der Erklärung erfüllt die nachfolgend bezeichneten EU-Richtlinien:  
The object of the declaration described above is in conformity with the following EU directives:

Richtlinie / Directive: **2011/65/EU** Richtlinie zur Beschränkung der Verwendung bestimmter gefährlicher Stoffe in Elektro- und Elektronikgeräten (**RoHS**) / Directive relating on the restriction of the use of certain hazardous substances in electrical and electronic equipment (**RoHS**)  
**2014/30/EU** Richtlinie über die elektromagnetische Verträglichkeit (**EMV**) / Directive relating to electromagnetic compatibility (**EMC**)  
**2014/53/EU** Richtlinie über die Bereitstellung von Funkanlagen auf dem Markt (**RED**) / Directive relating to the making available on the market of radio equipment (**RED**)

Folgende harmonisierte Normen und weitere technische Spezifikationen wurden angewandt:  
The following harmonized standards and other technical specifications were applied:

2011/65/EU	2014/30/EU	2014/53/EU
EN IEC 63000:2018	EN 61000-6-2:2005 EN 61000-6-3:2007+A1:2011 EN 61131-2:2007	EN 301 489-1 V2.2.3 EN 301 489-19 V2.1.1 EN 301 489-52 V1.1.0 EN 301 511 V12.5.1 EN 301 908-1 V13.1.1 EN 301 908-13 V13.1.1 EN 301 908-2 V13.1.1 EN 303 413 V1.1.1 EN 55032:2015 EN 55035:2017 EN 62311:2008 EN IEC 61010-2-201:2018

**EU-Konformitätserklärung  
EU-Declaration of Conformity**



---

Ort, Datum /  
Place, date: Minden, 10.06.2021



Unterschrift /  
Signature:

i.A. Marco Henkel  
Head of Business Unit Automation

**Diese Erklärung bescheinigt die Übereinstimmung mit den genannten Richtlinien, beinhaltet jedoch keine Zusicherung von Eigenschaften. Die Sicherheitshinweise der Produktdokumentation sind zu beachten.  
This declaration certifies compliance with the indicated directives but implies no warranty of properties. The safety instructions of the accompanying product documentation shall be observed.**

**EU - Konformitätserklärung  
EU - Declaration of Conformity**



Artikelnummer/ Item number:	750-453 0750-0453
Produktbezeichnung: Product designation:	4AI 4AI

Hersteller / Manufacturer: WAGO Kontakttechnik GmbH & Co. KG  
Hansastraße 27  
32423 Minden  
Germany  
www.wago.com

Die alleinige Verantwortung für die Ausstellung dieser Konformitätserklärung trägt der Hersteller.  
This declaration of conformity is issued under the sole responsibility of the manufacturer.  
Der oben genannte Gegenstand der Erklärung erfüllt die nachfolgend bezeichneten EU-Richtlinien:  
The object of the declaration described above is in conformity with the following EU directives:


- Richtlinie / Directive:
- 2011/65/EU Richtlinie zur Beschränkung der Verwendung bestimmter gefährlicher Stoffe in Elektro- und Elektronikgeräten (RoHS) / Directive relating on the restriction of the use of certain hazardous substances in electrical and electronic equipment (RoHS)
  - 2014/30/EU Richtlinie über die elektromagnetische Verträglichkeit (EMV) / Directive relating to electromagnetic compatibility (EMC)
  - 2014/34/EU Richtlinie für Geräte und Schutzsysteme zur bestimmungsgemäßen Verwendung in explosionsgefährdeten Bereichen (ATEX) / Directive relating to equipment and protective systems intended for use in potentially explosive atmospheres (ATEX)


Folgende harmonisierte Normen wurden angewandt:  
The following harmonized standards were applied:

2011/65/EU	2014/30/EU	2014/34/EU
EN 50581:2012	EN 61000-6-2:2005 EN 61000-6-3:2007+A1:2011	EN 60079-0:2012+A11:2013 EN 60079-15:2010

Ort, Datum /  
Place, date: Minden, 12.07.2019

Unterschrift /  
Signature:

  
i.A. Marcus Redeker  
Head of Product Line Coupler & IO

  
i.A. Thomas Hüttemeier  
Head of Business Unit Automation

Diese Erklärung bescheinigt die Übereinstimmung mit den genannten Richtlinien, beinhaltet jedoch keine Zusicherung von Eigenschaften. Die Sicherheitshinweise der Produktdokumentation sind zu beachten.  
This declaration certifies compliance with the indicated directives but implies no warranty of properties. The safety instructions of the accompanying product documentation shall be observed.

**EU - Konformitätserklärung**  
**EU - Declaration of Conformity**



**Produktbezeichnung:** **0750-1405**  
**Product designation:**

Hersteller / Manufacturer: WAGO Kontakttechnik GmbH & Co. KG  
 HansasträÙe 27  
 32423 Minden  
 Germany  
 www.wago.com

Die alleinige Verantwortung für die Ausstellung dieser Konformitätserklärung trägt der Hersteller.  
 This declaration of conformity is issued under the sole responsibility of the manufacturer.  
 Der oben genannte Gegenstand der Erklärung erfüllt die nachfolgend bezeichneten EU-Richtlinien:  
 The object of the declaration described above is in conformity with the following EU directives:

- Richtlinie / Directive:
- 2011/65/EU** Richtlinie zur Beschränkung der Verwendung bestimmter gefährlicher Stoffe in Elektro- und Elektronikgeräten (RoHS) / Directive relating on the restriction of the use of certain hazardous substances in electrical and electronic equipment (RoHS)
  - 2014/30/EU** Richtlinie über die elektromagnetische Verträglichkeit (EMV) / Directive relating to electromagnetic compatibility (EMC)
  - 2014/34/EU** Richtlinie für Geräte und Schutzsysteme zur bestimmungsgemäÙen Verwendung in explosionsgefährdeten Bereichen (ATEX) / Directive relating to equipment and protective systems intended for use in potentially explosive atmospheres (ATEX)

Folgende harmonisierte Normen wurden angewandt:  
 The following harmonized standards were applied:

2011/65/EU	2014/30/EU	2014/34/EU
EN 50581:2012	EN 61000-6-2:2005 EN 61000-6-3:2007+A1:2011 EN 61131-2:2007	EN 60079-0:2012+A11:2013 EN 60079-15:2010

Ort, Datum / Place, date: Minden, 20.03.2018

Unterschrift / Signature:

*i.A. M. Redeker*  
 Marcus Redeker  
 Head of Product Line

*i.A. T. Hüttemeier*  
 Thomas Hüttemeier  
 Head of Automation

Diese Erklärung bescheinigt die Übereinstimmung mit den genannten Richtlinien, beinhaltet jedoch keine Zusicherung von Eigenschaften. Die Sicherheitshinweise der Produktdokumentation sind zu beachten.  
 This declaration certifies compliance with the indicated directives but implies no warranty of properties. The safety instructions of the accompanying product documentation shall be observed.



**EU - Konformitätserklärung  
EU - Declaration of Conformity**



Artikelnummer/ Item number: 750-552  
0750-0552

Produktbezeichnung: 2AO  
Product designation: 2AO

Hersteller / Manufacturer: WAGO Kontakttechnik GmbH & Co. KG  
Hansastraße 27  
32423 Minden  
Germany  
www.wago.com

Die alleinige Verantwortung für die Ausstellung dieser Konformitätserklärung trägt der Hersteller.  
This declaration of conformity is issued under the sole responsibility of the manufacturer.  
Der oben genannte Gegenstand der Erklärung erfüllt die nachfolgend bezeichneten EU-Richtlinien:  
The object of the declaration described above is in conformity with the following EU directives:

Richtlinie / Directive: **2011/65/EU** Richtlinie zur Beschränkung der Verwendung bestimmter gefährlicher Stoffe in Elektro- und Elektronikgeräten (**RoHS**) / Directive relating on the restriction of the use of certain hazardous substances in electrical and electronic equipment (**RoHS**)

**2014/30/EU** Richtlinie über die elektromagnetische Verträglichkeit (**EMV**) / Directive relating to electromagnetic compatibility (**EMC**)

**2014/34/EU** Richtlinie für Geräte und Schutzsysteme zur bestimmungsgemäßen Verwendung in explosionsgefährdeten Bereichen (**ATEX**) / Directive relating to equipment and protective systems intended for use in potentially explosive atmospheres (**ATEX**)

Folgende harmonisierte Normen wurden angewandt:  
The following harmonized standards were applied:

2011/65/EU	2014/30/EU	2014/34/EU
EN 50581:2012	EN 61000-6-2:2005 EN 61000-6-3:2007+A1:2011	EN 60079-0:2012+A11:2013 EN 60079-15:2010

Ort, Datum /  
Place, date: Minden, 12.07.2019

Unterschrift /  
Signature:

  
i.A. Marcus Redeker  
Head of Product Line Coupler & IO

  
i.A. Thomas Hüttemeier  
Head of Business Unit Automation

Diese Erklärung bescheinigt die Übereinstimmung mit den genannten Richtlinien, beinhaltet jedoch keine Zusicherung von Eigenschaften. Die Sicherheitshinweise der Produktdokumentation sind zu beachten.  
This declaration certifies compliance with the indicated directives but implies no warranty of properties. The safety instructions of the accompanying product documentation shall be observed.

**EU - Konformitätserklärung**  
**EU - Declaration of Conformity**



**Produktbezeichnung:** **0750-0530**  
**Product designation:**

Hersteller / Manufacturer: WAGO Kontakttechnik GmbH & Co. KG  
 Hansastraße 27  
 32423 Minden  
 Germany  
 www.wago.com

Die alleinige Verantwortung für die Ausstellung dieser Konformitätserklärung trägt der Hersteller.  
 This declaration of conformity is issued under the sole responsibility of the manufacturer.  
 Der oben genannte Gegenstand der Erklärung erfüllt die nachfolgend bezeichneten EU-Richtlinien:  
 The object of the declaration described above is in conformity with the following EU directives:

- Richtlinie / Directive:
- 2011/65/EU** Richtlinie zur Beschränkung der Verwendung bestimmter gefährlicher Stoffe in Elektro- und Elektronikgeräten (RoHS) / Directive relating on the restriction of the use of certain hazardous substances in electrical and electronic equipment (RoHS)
  - 2014/30/EU** Richtlinie über die elektromagnetische Verträglichkeit (EMV) / Directive relating to electromagnetic compatibility (EMC)
  - 2014/34/EU** Richtlinie für Geräte und Schutzsysteme zur bestimmungsgemäßen Verwendung in explosionsgefährdeten Bereichen (ATEX) / Directive relating to equipment and protective systems intended for use in potentially explosive atmospheres (ATEX)

Folgende harmonisierte Normen wurden angewandt:  
 The following harmonized standards were applied:

2011/65/EU	2014/30/EU	2014/34/EU
EN 50581:2012	EN 61000-6-2:2005 EN 61000-6-4:2007+A1:2011 EN 61131-2:2007	EN 60079-0:2012+A11:2013 EN 60079-15:2010

Ort, Datum / Place, date: Minden, 20.03.2018

Unterschrift / Signature:

  
 Marcus Redeker  
 Head of Product Line

  
 Thomas Hüttemeier  
 Head of Automation

Diese Erklärung bescheinigt die Übereinstimmung mit den genannten Richtlinien, beinhaltet jedoch keine Zusicherung von Eigenschaften. Die Sicherheitshinweise der Produktdokumentation sind zu beachten.  
 This declaration certifies compliance with the indicated directives but implies no warranty of properties. The safety instructions of the accompanying product documentation shall be observed.



**EU - Konformitätserklärung  
EU - Declaration of Conformity**



**Produktbezeichnung:  
Product designation:** **0750-0600**

**Hersteller / Manufacturer:** WAGO Kontakttechnik GmbH & Co. KG  
Hansastraße 27  
32423 Minden  
Germany  
www.wago.com

**Die alleinige Verantwortung für die Ausstellung dieser Konformitätserklärung trägt der Hersteller.  
This declaration of conformity is issued under the sole responsibility of the manufacturer.  
Der oben genannte Gegenstand der Erklärung erfüllt die nachfolgend bezeichneten EU-Richtlinien:  
The object of the declaration described above is in conformity with the following EU directives:**

**Richtlinie / Directive:**

- 2011/65/EU** Richtlinie zur Beschränkung der Verwendung bestimmter gefährlicher Stoffe in Elektro- und Elektronikgeräten (RoHS) / Directive relating on the restriction of the use of certain hazardous substances in electrical and electronic equipment (RoHS)
- 2014/30/EU** Richtlinie über die elektromagnetische Verträglichkeit (EMV) / Directive relating to electromagnetic compatibility (EMC)
- 2014/34/EU** Richtlinie für Geräte und Schutzsysteme zur bestimmungsgemäßen Verwendung in explosionsgefährdeten Bereichen (ATEX) / Directive relating to equipment and protective systems intended for use in potentially explosive atmospheres (ATEX)

**Folgende harmonisierte Normen wurden angewandt:  
The following harmonized standards were applied:**

2011/65/EU	2014/30/EU	2014/34/EU
EN 50581:2012	EN 61000-6-2:2005 EN 61000-6-3:2007+A1:2011	EN 60079-0:2012+A11:2013 EN 60079-15:2010

**Ort, Datum / Place, date:** Minden, 23.04.2018

**Unterschrift / Signature:**

  
Marcus Redeker  
Head of Product Line Coupler & IO

  
Thomas Hüttemeier  
Head of Automation

**Diese Erklärung bescheinigt die Übereinstimmung mit den genannten Richtlinien, beinhaltet jedoch keine Zusicherung von Eigenschaften. Die Sicherheitshinweise der Produktdokumentation sind zu beachten.  
This declaration certifies compliance with the indicated directives but implies no warranty of properties. The safety instructions of the accompanying product documentation shall be observed.**

EU - Konformitätserklärung  
EU - Declaration of Conformity



Artikelnummer/ Item number: 758-879/000-001  
0758-0879/0000-0001

Produktbezeichnung: Memory Card SD  
Product designation: Memory Card SD

Hersteller / Manufacturer: WAGO Kontakttechnik GmbH & Co. KG  
Hansastraße 27  
32423 Minden  
Germany  
www.wago.com

Die alleinige Verantwortung für die Ausstellung dieser Konformitätserklärung trägt der Hersteller.  
This declaration of conformity is issued under the sole responsibility of the manufacturer.  
Der oben genannte Gegenstand der Erklärung erfüllt die nachfolgend bezeichneten EU-Richtlinien:  
The object of the declaration described above is in conformity with the following EU directives:

Richtlinie / Directive: 2011/65/EU Richtlinie zur Beschränkung der Verwendung bestimmter gefährlicher Stoffe in Elektro- und Elektronikgeräten (RoHS) / Directive relating on the restriction of the use of certain hazardous substances in electrical and electronic equipment (RoHS)  
2014/30/EU Richtlinie über die elektromagnetische Verträglichkeit (EMV) / Directive relating to electromagnetic compatibility (EMC)

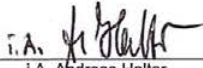
Folgende harmonisierte Normen wurden angewandt:  
The following harmonized standards were applied:


2011/65/EU  
EN 50581:2012

2014/30/EU  
EN 55024:2010+A1:2015  
EN 55032:2015

Ort, Datum /  
Place, date: Minden, 19.07.2019

Unterschrift /  
Signature:

  
i.A. Andreas Haller  
Head of Product Line Controller & HMI

  
i.A. Thomas Hüttemeier  
Head of Business Unit Automation

Diese Erklärung bescheinigt die Übereinstimmung mit den genannten Richtlinien, beinhaltet jedoch keine  
Zusicherung von Eigenschaften. Die Sicherheitshinweise der Produktdokumentation sind zu beachten.  
This declaration certifies compliance with the indicated directives but implies no warranty of properties. The safety  
instructions of the accompanying product documentation shall be observed.

## UK-Declaration of Conformity



<b>Item number:</b>	<b>750-8217</b> <b>0750-8217</b>
---------------------	-------------------------------------

<b>Product designation:</b>	<b>Controller PFC200</b>
-----------------------------	--------------------------

Manufacturer: WAGO GmbH & Co. KG  
Hansastraße 27  
32423 Minden  
Germany  
www.wago.com

**This attestation of conformity is issued under the sole responsibility of the manufacturer.  
The object of the attestation described above is in conformity with the following UK regulations:**

Regulations: **S.I. 2012/3032** The Restriction of the Use of Certain Hazardous Substances in Electrical and Electronic Equipment Regulations 2012  
**S.I. 2016/1091** Electromagnetic Compatibility Regulations 2016  
**S.I. 2017/1206** Radio Equipment Regulations 2017

**The following designated standards and other technical specifications were applied:**

S.I. 2012/3032	S.I. 2016/1091	S.I. 2017/1206
EN IEC 63000:2018	EN 61000-6-2:2005 EN 61000-6-3:2007+A1:2011 EN 61131-2:2007 EN IEC 61000-6-2:2019 EN IEC 61000-6-3:2021	EN 301 489-1 V2.2.3 EN 301 489-52 V1.1.2 EN 301 511 V12.5.1 EN 301 908-1 V13.1.1 EN 301 908-13 V13.1.1 EN 301 908-2 V13.1.1 EN 303 413 V1.1.1 EN 50665:2017 EN 55032:2015+A11:2020 EN 55035:2017+A11:2020 EN 62311:2008 EN IEC 61010-2-201:2018 EN IEC 62311:2020

## UK-Declaration of Conformity



---

Place, date: Minden, 09.08.2022



Signature:

i.A. Sascha Krietenstein  
Head of Development Services

**This declaration certifies compliance with the indicated regulations but implies no warranty of properties. The safety instructions of the accompanying product documentation shall be observed.**

## UK-Declaration of Conformity



**Item number:** 750-453  
0750-0453

**Product designation:** 4-channel analog input

**Manufacturer:** WAGO GmbH & Co. KG  
Hansastraße 27  
32423 Minden  
Germany  
www.wago.com

**This attestation of conformity is issued under the sole responsibility of the manufacturer.  
The object of the attestation described above is in conformity with the following UK regulations:**

**Regulations:** **S.I. 2012/3032** The Restriction of the Use of Certain Hazardous Substances in Electrical and Electronic Equipment Regulations 2012  
**S.I. 2016/1091** Electromagnetic Compatibility Regulations 2016  
**S.I. 2016/1107** Equipment and Protective Systems Intended for use in Potentially Explosive Atmospheres Regulations 2016

**The following designated standards and other technical specifications were applied:**

S.I. 2012/3032	S.I. 2016/1091	S.I. 2016/1107
EN IEC 63000:2018	EN 61000-6-2:2005 EN 61000-6-3:2007+A1:2011 EN IEC 61000-6-2:2019 EN IEC 61000-6-3:2021	EN IEC 60079-0:2018 EN IEC 60079-7:2015+A1:2018

**Place, date:** Minden, 25.07.2022

**Signature:**

  
i.A. Sascha Krietenstein  
Head of Development Services

**This declaration certifies compliance with the indicated regulations but implies no warranty of properties. The safety instructions of the accompanying product documentation shall be observed.**



## UK-Declaration of Conformity



**Item number:** 750-1405  
0750-1405

**Product designation:** 16-channel digital input

**Manufacturer:** WAGO GmbH & Co. KG  
Hansastraße 27  
32423 Minden  
Germany  
www.wago.com

**This attestation of conformity is issued under the sole responsibility of the manufacturer.  
The object of the attestation described above is in conformity with the following UK regulations:**

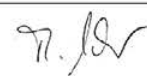
**Regulations:** **S.I. 2012/3032** The Restriction of the Use of Certain Hazardous Substances in Electrical and Electronic Equipment Regulations 2012  
**S.I. 2016/1091** Electromagnetic Compatibility Regulations 2016  
**S.I. 2016/1107** Equipment and Protective Systems Intended for use in Potentially Explosive Atmospheres Regulations 2016

**The following designated standards and other technical specifications were applied:**

S.I. 2012/3032	S.I. 2016/1091	S.I. 2016/1107
EN IEC 63000:2018	EN 61000-6-2:2005 EN 61000-6-3:2007+A1:2011 EN 61131-2:2007 EN IEC 61000-6-2:2019	EN IEC 60079-0:2018 EN IEC 60079-7:2015+A1:2018

Place, date: Minden, 06.05.2022

Signature:



i.A. Thomas Maschler  
Head of System

**This declaration certifies compliance with the indicated regulations but implies no warranty of properties. The safety instructions of the accompanying product documentation shall be observed.**

## UK-Declaration of Conformity



Item number: 750-552  
0750-0552

Product designation: 2-channel analog output

Manufacturer: WAGO GmbH & Co. KG  
Hansastraße 27  
32423 Minden  
Germany  
www.wago.com

**This attestation of conformity is issued under the sole responsibility of the manufacturer.  
The object of the attestation described above is in conformity with the following UK regulations:**


Regulations: **S.I. 2012/3032** The Restriction of the Use of Certain Hazardous Substances in Electrical and Electronic Equipment Regulations 2012  
**S.I. 2016/1091** Electromagnetic Compatibility Regulations 2016  
**S.I. 2016/1107** Equipment and Protective Systems Intended for use in Potentially Explosive Atmospheres Regulations 2016

**The following designated standards and other technical specifications were applied:**

S.I. 2012/3032	S.I. 2016/1091	S.I. 2016/1107
EN IEC 63000:2018	EN 61000-6-2:2005 EN 61000-6-3:2007+A1:2011 EN IEC 61000-6-2:2019	EN IEC 60079-0:2018 EN IEC 60079-7:2015+A1:2018

Place, date: Minden, 11.04.2022

Signature:



i.A. Thomas Maschler  
Head of System

**This declaration certifies compliance with the indicated regulations but implies no warranty of properties. The safety instructions of the accompanying product documentation shall be observed.**

## UK-Declaration of Conformity



Item number: 750-530  
0750-0530

Product designation: 8-channel digital output

Manufacturer: WAGO GmbH & Co. KG  
Hansastraße 27  
32423 Minden  
Germany  
www.wago.com

This attestation of conformity is issued under the sole responsibility of the manufacturer.  
The object of the attestation described above is in conformity with the following UK regulations:

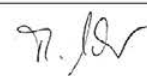
Regulations: **S.I. 2012/3032** The Restriction of the Use of Certain Hazardous Substances in Electrical and Electronic Equipment Regulations 2012  
**S.I. 2016/1091** Electromagnetic Compatibility Regulations 2016  
**S.I. 2016/1107** Equipment and Protective Systems Intended for use in Potentially Explosive Atmospheres Regulations 2016

The following designated standards and other technical specifications were applied:

S.I. 2012/3032	S.I. 2016/1091	S.I. 2016/1107
EN IEC 63000:2018	EN 61000-6-2:2005 EN 61000-6-3:2007+A1:2011 EN 61131-2:2007 EN IEC 61000-6-2:2019	EN IEC 60079-0:2018 EN IEC 60079-7:2015+A1:2018

Place, date: Minden, 30.05.2022

Signature:



i.A. Thomas Maschler  
Head of System

This declaration certifies compliance with the indicated regulations but implies no warranty of properties. The safety instructions of the accompanying product documentation shall be observed.



## UK-Declaration of Conformity



Item number: 750-600  
0750-0600

Product designation: End module

Manufacturer: WAGO GmbH & Co. KG  
Hansastraße 27  
32423 Minden  
Germany  
www.wago.com

**This attestation of conformity is issued under the sole responsibility of the manufacturer.  
The object of the attestation described above is in conformity with the following UK regulations:**

Regulations: **S.I. 2012/3032** The Restriction of the Use of Certain Hazardous Substances in Electrical and Electronic Equipment Regulations 2012  
**S.I. 2016/1091** Electromagnetic Compatibility Regulations 2016  
**S.I. 2016/1107** Equipment and Protective Systems Intended for use in Potentially Explosive Atmospheres Regulations 2016

**The following designated standards and other technical specifications were applied:**

S.I. 2012/3032	S.I. 2016/1091	S.I. 2016/1107
EN IEC 63000:2018	EN 61000-6-2:2005 EN 61000-6-3:2007+A1:2011 EN 61131-2:2007 EN IEC 61000-6-2:2019	EN IEC 60079-0:2018 EN IEC 60079-7:2015+A1:2018

Place, date: Minden, 03.05.2022

Signature:



i.A. Thomas Maschler  
Head of System

**This declaration certifies compliance with the indicated regulations but implies no warranty of properties. The safety instructions of the accompanying product documentation shall be observed.**