

## Instruction Manual

### Data Logger NivuLink Micro II / NivuLink Micro II Ex



Firmware Version: 1.1.x

**Revised Instruction Manual**

Document Revision 06 / 11.07.2022

Original Instruction Manual: German / Rev. 06 / 22.06.2022

measure analyse optimise

**NIVUS AG**

Burgstrasse 28  
8750 Glarus, Switzerland  
Phone +41 55 6452066  
Fax +41 55 6452014  
swiss@nivus.com  
www.nivus.com

**NIVUS Austria**

Mühlbergstraße 33B  
3382 Loosdorf, Austria  
Phone +43 2754 5676321  
Fax +43 2754 5676320  
austria@nivus.com  
www.nivus.com

**NIVUS Sp. z o.o.**

ul. Hutnicza 3 / B-18  
81-212 Gdynia, Poland  
Phone +48 58 7602015  
Fax +48 58 7602014  
biuro@nivus.pl  
www.nivus.pl

**NIVUS France**

12 rue Principale  
67870 Bischoffsheim, France  
Phone +33 388 999284  
info@nivus.fr  
www.nivus.fr

**NIVUS Ltd., United Kingdom**

Furzen Hill Farm  
Coventry Road, Cubbington  
Royal Leamington Spa  
CV32 7UJ, Warwickshire  
Phone +44 8445 332883  
nivusUK@nivus.com  
www.nivus.com

**NIVUS Middle East (FZE)**

Building Q 1-1 ap. 055  
P.O. Box: 9217  
Sharjah Airport International  
Free Zone  
Phone +971 6 5578224  
Fax +971 6 5578225  
middle-east@nivus.com  
www.nivus.com

**NIVUS Korea Co. Ltd.**

#2301 M-Dong Technopark IT Center,  
32 Songdogwahak-ro, Yeonsu-gu,  
INCHEON, Korea 21984  
Phone +82 32 2098588  
Fax +82 32 2098590  
jhwon@nivuskorea.com  
www.nivuskorea.com

**NIVUS Vietnam**

238/78 Phan Trung Street,  
Tan Tien Ward, Bin Hoa City,  
Dong Nai Province, Vietnam  
Phone +84 94 2623979  
jhwon@nivuskorea.com  
www.nivus.com

## Copyrights and Property Rights

The contents of this document including tables and drawings are proprietary to NIVUS GmbH and are not to be reproduced or copied without express written permission.

Violations oblige to compensation.



---

### **Copyright**

*This instruction manual - even in parts - may exclusively be copied or translated in any other way with the express written consent of NIVUS GmbH.*

---

### **Translation**

If the device is sold to a country in the European Economic Area this instruction manual must be translated into the language of the country in which the device is to be used.

Should the translated text be unclear, the original instruction manual (German) must be consulted or a member company of the NIVUS group must be contacted for clarification.

### **Copyright**

No part of this publication may be reproduced, transmitted, sold or disclosed without prior permission. All rights reserved.

### **Names**

The use of general descriptive names, trade names, trademarks and the like in this manual does not entitle the reader to assume they may be used freely by everyone. They are often protected registered trademarks even if not marked as such.

## Revision History

Rev.	Modifications	Responsible Editor	Date
06	Revision of the entire manual due to the transformation of the NivuLink Micro into the 2 <sup>nd</sup> generation: NivuLink Micro II	MoG	11.07.2022
01...05	Revision of the manual for the 1 <sup>st</sup> generation	KG	various
00	New creation of the manual for the 1 <sup>st</sup> generation	KG	25.10.2018

## Table of Contents

<b><u>Copyrights and Property Rights</u></b>	<b>3</b>
<b><u>Revision History</u></b>	<b>4</b>
<b><u>Table of Contents</u></b>	<b>5</b>
<b><u>General</u></b>	<b>9</b>
1 About this Manual.....	9
1.1 Applicable Documentation .....	9
1.2 Signs and Definitions used .....	9
1.3 Abbreviations used.....	10
1.3.1 Colour code for wires and single conductors .....	10
1.3.2 Abbreviations, common .....	10
2 Connections and Control Elements.....	10
2.1 Power Supply .....	10
2.1.1 Data Logger .....	10
2.1.2 Batteries .....	11
2.2 Control Elements of the NivuLink Micro II .....	11
2.3 Interfaces .....	12
<b><u>Safety Instructions</u></b>	<b>13</b>
3 Used Symbols and Signal Words.....	13
3.1 Information on the Valuation of Accident Levels.....	13
3.2 Warning Notices on the Device (optional).....	14
3.2.1 Common.....	14
3.2.2 Special/type-related (Ex-relevant, battery, cleaning) .....	14
4 Special safety and Precautionary Measures.....	14
5 Warranty.....	16
6 Disclaimer.....	16
7 Intended Use .....	17
8 Ex Protection .....	17
9 Duties of the Operator .....	18
10 Requirements for the Personnel .....	18
<b><u>Delivery, Storage and Transport</u></b>	<b>19</b>
11 Scope of Delivery .....	19
12 Inspection upon Receipt.....	19
13 Storage.....	19
14 Transport.....	19
15 Return.....	20
<b><u>Product Description</u></b>	<b>21</b>
16 Product Construction and Overview.....	21
16.1 Enclosure dimensions .....	22
16.2 Connectable Sensors/Probes .....	23
17 Device ID.....	23
17.1 Nameplates NivuLink Micro II .....	23

18 Specifications .....	24
18.1 NivuLink Micro II.....	24
18.2 Sensors .....	25
19 Equipment/Device Versions .....	26
19.1 Product Structure .....	26
19.2 Add-On Function Licences.....	26
<b>Function Description</b> .....	<b>27</b>
20 Functional Principle .....	27
<b>Installation and Connection</b> .....	<b>28</b>
21 General Installation Information .....	28
21.1 Mounting Place .....	28
21.2 Gaskets .....	28
21.3 Cable Glands .....	29
22 Open / Close the Data Logger Enclosure .....	29
23 Fastening the Data Logger.....	30
24 Prepare, insert / change SIM card .....	33
24.1 Activate PIN .....	33
24.2 Insert / change SIM card in the data logger .....	33
25 Antenna Installation.....	34
26 Electrical Installation/Power Supply .....	34
26.1 General Information on the Power Supply.....	34
26.2 Removing/installing the batteries .....	35
27 Installation of Sensors.....	36
27.1 Sensor Installation Principles.....	36
28 Connection of Sensors / the Rain Gauge .....	36
28.1 Terminal Wiring.....	36
28.2 Cable for Sensor Connection.....	37
28.3 Connecting Sensors.....	37
28.4 Connecting the Rain Gauge.....	38
<b>Commissioning</b> .....	<b>40</b>
29 Notes to the User .....	40
30 Lighting System of the Status LED on NivuLink Micro II.....	41
31 Connection Setup.....	43
31.1 Common.....	43
31.2 Windows Operating System.....	43
32 Menu Control/Overview.....	45
32.1 Overview Display .....	45
32.2 Save Parameters .....	46
32.3 Menus.....	47
<b>Main Screen</b> .....	<b>48</b>
33 Functions of the Main Screen .....	48
34 General Overview.....	48
35 Display Fields .....	50
35.1 Display fields input 1..4.....	50

<b>Setting Parameters</b>	<b>51</b>
36 General Programming .....	51
36.1 Save Parameters .....	51
36.2 Change User Name .....	51
36.3 Change Password.....	52
36.4 Loss of the Password.....	52
37 Parameter Functions.....	53
37.1 Main Menu .....	53
37.2 Functions of the first Menu Level .....	53
37.2.1 Menu - Application .....	53
37.2.2 Menu - Data .....	54
37.2.3 Menu - System .....	54
37.2.4 Menu - Communication.....	55
37.2.5 Menu - Battery.....	56
37.2.6 Menu - Alarm.....	56
38 Parameter Menu Application.....	57
38.1 Menu Measurement Place .....	57
38.2 Menu Inputs .....	58
38.3 Menu Digital Output .....	61
38.4 Menu Diagnostics.....	62
39 Parameter Menu Data.....	64
39.1 Menu Trend.....	65
39.2 Menu Data Memory.....	66
40 Parameter Menu System .....	68
40.1 Menu Information .....	68
40.2 Menu Country Settings.....	69
40.2.1 (Operating) Language.....	69
40.2.2 Date Format .....	69
40.2.3 Units .....	69
40.2.4 Data Units .....	70
40.3 Menu Time/Date.....	71
40.4 Menu Error Messages.....	72
40.5 Menu Service .....	73
40.5.1 Service Level.....	73
40.5.2 Restart.....	73
40.5.3 Powerdown .....	73
40.5.4 Parameter Reset .....	73
40.5.5 Feature Unlock.....	74
40.5.6 Update NivuLink Micro II.....	76
40.6 Menu Operating Mode .....	77
41 Parameter Menu Communication .....	79
41.1 Menu Data Transmission .....	80
41.1.1 Provider.....	80
41.1.2 Modem State.....	80
41.1.3 GPS.....	81
41.1.4 SIM Card .....	81
41.1.5 DNS.....	81
41.1.6 Ping .....	81
41.1.7 MQTT .....	81
41.1.8 FTP (only with licence).....	82

41.1.9 E-Mail (only with licence) .....	84
41.1.10 Preparing the device for data transmission .....	85
41.2 Modbus.....	86
41.3 HTTP .....	88
42 Parameter Menu Battery .....	88
43 Parameter Menu Alarm .....	89
43.1 Menu >Alarm< / >Battery (12V)< .....	89
43.2 Menu >Alarm< / >Temperature<.....	90
43.3 Menu >Alarm< / >Input x< .....	90
<b>Maintenance and Cleaning</b> .....	<b>92</b>
44 Maintenance.....	92
44.1 Maintenance Interval.....	92
44.2 Maintenance Tasks.....	93
44.2.1 Clean, check and replace Seals .....	93
44.2.2 Replace batteries .....	93
44.3 Customer Service Information .....	94
45 Cleaning .....	94
45.1 Data Logger .....	94
45.2 Sensors .....	94
46 Dismantling/Disposal.....	94
47 Installation of Spare Parts and Wearing Parts .....	95
47.1 Battery Replacement.....	95
48 Accessories .....	96
<b>Index</b> .....	<b>98</b>
<b>Credits and Licenses</b> .....	<b>100</b>
49 List of Sources of the Licences and Codes used.....	100
<b>Approvals and Certificates</b> .....	<b>101</b>



## General

### 1 About this Manual



#### **Important**

*READ CAREFULLY BEFORE USE.*

*KEEP IN A SAFE PLACE FOR LATER REFERENCE.*

This instruction manual is for the NivuLink Micro II data logger and serves its intended use. This instruction manual is oriented exclusively to qualified expert personnel.

Read this instruction manual carefully and completely prior to installation or connection since it contains relevant information on this product. Observe the notes and particularly follow the warning notes and safety instructions.

If you should have problems to understand information contained within this instruction manual either contact a member company of the NIVUS group or one of the distributors for further support. The member companies of the NIVUS group cannot be held responsible for damage to persons or material due to incorrectly understood information in this instruction.




#### 1.1 Applicable Documentation

For the installation and operation of the complete system extra instruction manuals or technical descriptions may be required apart from this manual.

- Instruction manuals for intelligent i-Series sensors
- Instruction manual(s) for pressure and level probes: NivuBar Plus II, NivuBar G II, NivuBar H III, HydroBar G II, UniBar E II, AquaBar BA, AquaBar II
- Instruction manual measurement device Rain Gauge Type RM 200 / 202

These manuals are provided with the auxiliary units or sensors and/or are available as download on the NIVUS homepage.

#### 1.2 Signs and Definitions used

Representation	Meaning	Remarks
	(Action) Step	Execute action steps. Should action steps be numbered observe the specified order of the steps.
	Cross-reference	Refers to further or more detailed information.
>Text<	Parameter or menu	Indicates a parameter or a menu that is to be selected or is described.
	Refers to a documentation	Refers to an accompanying documentation.

Tab. 1 Structural elements within the manual

## 1.3 Abbreviations used

### 1.3.1 Colour code for wires and single conductors

The abbreviations of colours for wire and single conductor labelling follow the international colour code according IEC 60757.

BK	Black	BN	Brown	RD	Red
OG	Orange	YE	Yellow	GN	Green
BU	Blue	VT	Violet	GY	Grey
WH	White	PK	Pink	TQ	Turquoise
GNYE	Green/Yellow	GD	Gold	SR	Silver

### 1.3.2 Abbreviations, common

The following device/subject-related abbreviations are used within the document:

NLG02 NivuLink Micro II

## 2 Connections and Control Elements

### 2.1 Power Supply

#### 2.1.1 Data Logger

The NivuLink Micro II (Fig. 2-1) is powered via the batteries.

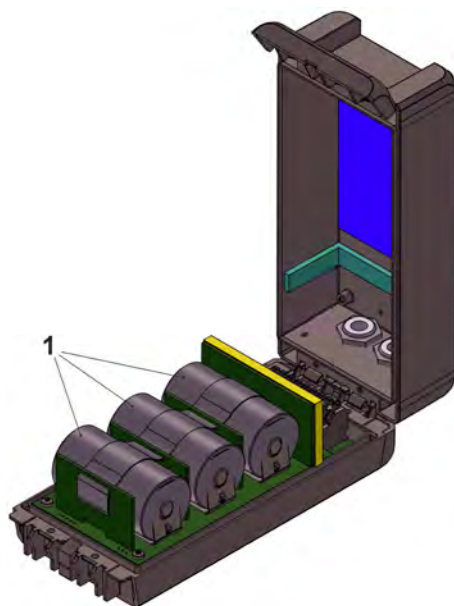


Fig. 2-1 Power supply by batteries

## 2.1.2 Batteries

The data logger is designed to operate with three batteries.

The batteries can be purchased from a supplier other than NIVUS. However, only batteries approved by NIVUS are permitted (see Chap. "18 Specifications" and "47 Installation of Spare Parts and Wearing Parts").

The battery life depends not only on the operating mode and the battery capacity, but also on the ambient temperature, any battery batch tolerances, the reception quality at the installation site, etc.



### **Standard batteries are not rechargeable**

The batteries **cannot** be recharged.



### **Storage tips for the batteries**

*By basically storing and using the batteries at non-critical temperatures (such as room temperature) and storing them dust-free, clean and dry, their capacity can be maintained for longer.*

*This means that even remote data transmission can often still work well at values in the lower capacity range.*

## 2.2 Control Elements of the NivuLink Micro II

The NivuLink Micro II is activated by the reed contact (status LED) on the front. This is done by the enclosed ring magnet *ZUBO NFM MAGNET* (Fig. 2-2).

Beyond that, the NivuLink Micro II has no other control elements. The entire operation and the parameterisation are carried out via notebook or PC (using the NIVUS WebPortal if necessary).



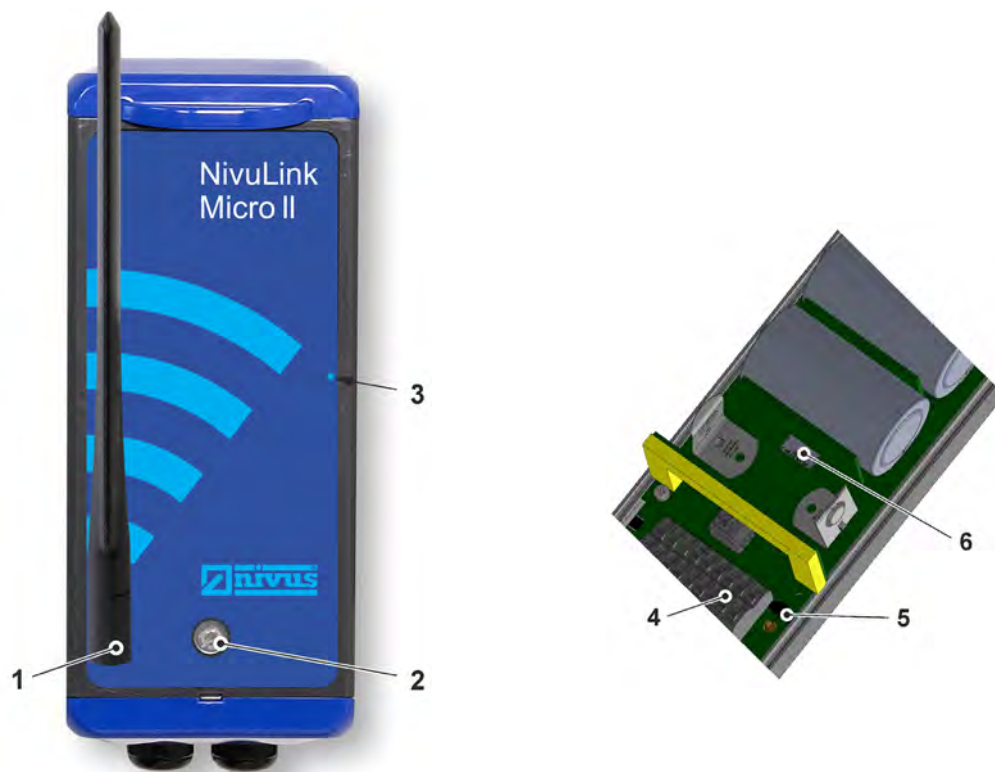
Also observe the instruction manuals for the notebook or PC you are using.



**Fig. 2-2** Ring magnet

## 2.3 Interfaces

The data logger is equipped with several interfaces. These are on the front of the enclosure or inside the unit respectively (requires to open the flap).



- 1 SMA antenna socket (for 2G/3G/4G antenna)
- 2 LED (status display)
- 3 Reed contact (wake-up via magnet)
- 4 Terminal block (RS485 interface, universal inputs and digital output)  
(see also Fig. 28-1; with open enclosure flap)
- 5 Micro-USB interface (with open enclosure flap)
- 6 2G/3G/4G SIM card slot (in connection with 2G/3G/4G antenna; with open enclosure flap)

**Fig. 2-3 Available interfaces**

## Safety Instructions

### 3 Used Symbols and Signal Words

#### 3.1 Information on the Valuation of Accident Levels



The general warning symbol indicates the risk of personal injuries or death. In the text section the general warning symbol is used in combination with the signal words described below.

**DANGER**



**Warning in high degree of risk**

Indicates a high-risk, **imminently** hazardous situation which will result in death or serious injury if not avoided.

**WARNING**



**Warning in medium degree of risk and personal injury**

Indicates a **possible** danger with medium risk which may result in a life-threatening situation or (severe) bodily injury if not avoided.

**CAUTION**



**Warning in personal injury or property damage**

Indicates a possible danger with moderate risk which may result in minor or moderate personal injury or property damage if not avoided.

**WARNING**



**Danger by electric voltage**

Indicates a medium-risk, **imminently** hazardous situation caused by electric shock which will result in death or (serious) injury if not avoided.



**Important Note**

Contains information that needs to be highlighted. Indicates a potentially harmful situation that may damage the product or something in its environment if not avoided.



**Note**

Contains tips or information.

## 3.2 Warning Notices on the Device (optional)

### 3.2.1 Common



#### **General Warning Notice**

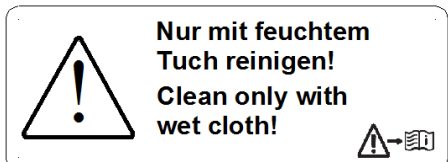
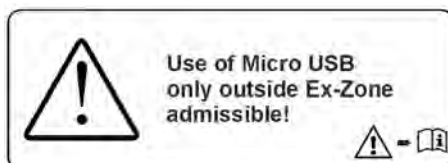
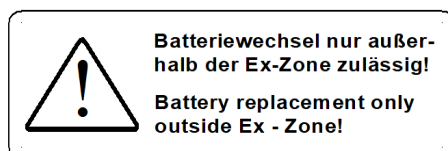
*This symbol refers the operator or user to content in this manual. Consideration of the information contained herein is necessary to maintain the protection provided by the unit for installation and in operation.*



#### **Protective earth connection**

*This symbol refers to the protective conductor terminal of the device. Depending on the type of installation, the unit may only be operated with a suitable protective earth connection in accordance with applicable laws and regulations.*

### 3.2.2 Special/type-related (Ex-relevant, battery, cleaning)



## 4 Special safety and Precautionary Measures

When working with the NIVUS equipment, the following safety and precautionary measures must be observed and followed generally and at all times. These warnings and notes are not repeated for each description within the document.

### **WARNING**



#### **Check danger due to explosive gases**

*Before starting assembly, installation and maintenance work, be sure to check that all regulations on safety at work have been observed and that there is no possible risk of explosive gases. Use a gas warner for the check.*

*When working in the sewer system, make sure that no electrostatic charge can occur:*

- *Avoid unnecessary movements to reduce the building-up of static charges.*
- *Discharge any static electricity present on your body before you start installing the sensor.*

*Disregarding may result in personal injury or damage to the system.*

**WARNING**



**Open the device only out of Ex areas**

*Do not open, service or repair in an area where an explosive atmosphere is present.*

---

**WARNING**



**Germ Contamination**

*Due to the frequent use of the sensors in the waste water sector, parts can be contaminated with dangerous germs. Therefore, appropriate precautions must be taken when coming into contact with cables and sensors.*

*Wear protective clothing.*

---

**WARNING**



**Observe Occupational Safety Regulations!**

*Before and during mounting works, compliance with all work safety regulations must always be ensured.*

*Disregarding may lead to personal injury.*

---

**WARNING**



**Do not disable Safety Devices!**

*It is strictly forbidden to disable the safety devices or to change their mode of operation.*

*Disregarding may result in personal injury or damage to the system.*

---

**WARNING**



**Disconnect the System from Mains Power**

*Disconnect the instrument from mains power (if connected) before you begin maintenance, cleaning and/or repair works (qualified personnel only).*

*Disregarding may lead to electric shock.*

---



**Commissioning only by qualified Personnel**

*The entire measuring system may only be installed and commissioned by qualified personnel.*

**Special conditions for outdoor use**

*The products of the NIVUS GmbH for outdoor use have extensive protection against the ingress of dust and moisture. If these products are connected to the power supply or to the sensors / actuators by cables with plugs instead of permanently installed wiring, then there is a risk of dirt, dust and moisture penetrating the plug and socket. It is the operator's responsibility to protect the plug and socket from the ingress of dirt, dust and moisture and to comply with local safety regulations.*

---

## 5 Warranty

The device was functionally tested prior to shipping. When used for the intended purpose (see Chap. "7 Intended Use") and in compliance with the instruction manual, the applicable (see Chap. "1.1 Applicable Documentation") and the safety information and instructions contained therein, no functional restrictions are to be expected and flawless operation should be possible.



Please also refer to the following chapter "6 Disclaimer".



---

### **Limitation of Warranty**

*In case of disregarding the safety notes and instructions in this document, the companies of the NIVUS-Group reserve the right to limit the warranty.*

---

## 6 Disclaimer

### **The companies of the NIVUS-Group assume no liability**

- for consequential damages resulting from a change in this document. The companies of the NIVUS-Group reserve the right to change the contents of the document including this disclaimer without prior notice.
- for personal injury or damage to property resulting from **failure to comply** with the **applicable regulations**. For connection, commissioning and operation of the devices, all information and higher-level legal regulations of the country (in Germany e.g. the VDE regulations), such as valid Ex regulations as well as the safety and accident prevention regulations applicable to the respective individual case shall be observed.
- for personal injury or damage to property resulting from **improper handling**. For safety and warranty reasons, all work on the equipment that goes beyond the installation and connection measures may only be carried out by NIVUS personnel or by persons or companies authorised by NIVUS.
- for personal injury or damage to property resulting from the operation of the equipment in a **technically faulty** condition.
- for personal injury or damage to property resulting from **improper use**.
- for personal injury or damage to property resulting from **failure to observe the safety instructions** in this instruction manual.
- for missing or incorrect readings due to **improper installation** and for any consequential damage resulting therefrom.



---

### **No liability for data loss**

*If the device should be damaged and the data is not saved correctly, the companies of the NIVUS group of companies are not liable for data loss of any kind. The risk is the sole responsibility of the operator.*

---



## 7 Intended Use



### Note

*The device is intended exclusively for the purpose mentioned below. Any other use beyond this, any conversion or modification of the instrument without written agreement with the companies of the NIVUS-Group is considered improper use. The companies of the NIVUS-Group are not liable for any damage resulting from this. The operator alone bears the risk.*

The data logger NivuLink Micro II incl. associated sensors is intended for the cyclical or event-based determination of measurement data, the storage of the collected values and the remote transmission to (among others) a central server.

The NivuLink Micro II is designed and produced according to the current state of the art and the recognised safety rules at the time of publication of this document. Nevertheless, risks of personal injury or damage to property cannot be completely ruled out.

The permissible maximum limit values in Chapter "18 Specifications" must be observed. All cases of use deviating from these limit values, which have not been approved by NIVUS GmbH in writing, are excluded from the liability of the NIVUS-Group.

## 8 Ex Protection

The (portable) data logger NivuLink Micro II incl. associated sensors is designed for use in areas with explosive atmospheres of zone 1.

The following conditions must be observed:

- The enclosure of the data logger may only be opened **outside** the Ex area.
- Maintenance and repair shall only be carried out **outside** the Ex area.
- Batteries may only be removed/installed and charged **outside** the Ex area.
- In general, only batteries approved by NIVUS may be used **within** the Ex area.
- The Micro-USB interface is only permitted to be used **outside** the Ex area.
- The SIM card may only be exchanged **outside** the Ex area.

### Approval for Data Logger

➡ See Chap. "18 Specifications".



### Validity of the Ex Approval

*The Ex approval is only valid in conjunction with the corresponding marking on the nameplate of data logger and the sensors.*



### Declarations of Conformity and Test Certificates

*For installation and commissioning, the EU declarations of conformity and test certificates of the approving body must be strictly observed.*



### Ex Approval for Sensors

*The Ex approvals of the sensors are included with the "Instruction Manual for intelligent i-Series Sensors" or the "Instruction Manuals for Pressure and Level Probes: NivuBar Plus II, NivuBar G II, NivuBar H III, HydroBar G II, UniBar E II, AquaBar".*

## 9 Duties of the Operator



### **Important Note**

*In the EEA (European Economic Area), the national transposition of the Framework Directive (89/391/EEC) as well as the associated individual directives and, in particular, the Directive (2009/104/EC) concerning the minimum safety and health requirements for the use of work equipment by workers at work, as amended, must be observed and complied with.*

*In Germany, the Ordinance on Industrial Safety and Health must be complied with.*

Obtain the local operating licence and observe the associated conditions. In addition, you must comply with environmental protection requirements and local legal requirements for the following:

- Safety of personnel (accident prevention regulations)
- Safety of work equipment (protective equipment and maintenance)
- Product Disposal (Waste Management Act)
- Materials Disposal (Waste Management Act)
- Cleaning (Cleaning Agents and Disposal)

### **Connections**

As the operator, before activating the device, make sure that the local regulations (e.g. for the electrical connection) have been observed during installation and commissioning.

### **Keep the Instruction Manual for future Reference**

Keep the instruction manual in a safe place and ensure that it is always available and can be consulted by the user of the product.

### **Hand over the Instruction Manual**

When selling the data logger, this instruction manual must be handed over with it. The manual is part of the standard delivery.

## 10 Requirements for the Personnel

Installation, commissioning and maintenance may only be carried out by personnel who fulfil the following conditions:

- Qualified personnel with appropriate training
- Authorisation by plant operator



### **Qualified Personnel**

*in the sense of these instructions or the warnings on the product itself are persons who are familiar with the installation, assembly, commissioning and operation of the product and who have the qualifications appropriate to their job, such as*

- I. training and instruction or authorisation to switch circuits and devices/systems on and off, to earth and to label them in accordance with the standards of safety technology.*
- II. Training or instruction in accordance with safety technology standards in maintenance and use of appropriate safety equipment.*
- III. First Aid Training*

## Delivery, Storage and Transport

### 11 Scope of Delivery

The standard delivery of the NivuLink Micro II comprises:

- Data logger NivuLink Micro II (possibly incl. three inserted batteries) (variant/version according to delivery documents)
- Rod antenna (bendable) *NLFO ANTENNE*
- Ring magnet *ZUB0 NFM MAGNET* (Fig. 2-2)
- Jumper (short circuit bridge) (use only when connecting a Rain Gauge *RMT0*)
- 2x locking bolts (diameter 9 mm) (inserted into the screw connections on delivery)
- Instruction manual (with EU declaration of conformity) including all the necessary information for operating the NivuLink Micro II (printed or as a link to the NIVUS download centre)

Check additional accessories according to the order against the delivery note.

### 12 Inspection upon Receipt

Check the delivery for completeness and apparent intactness immediately after receipt. Report any transport damage immediately to the delivering carrier. Also send a written report to NIVUS GmbH in Eppingen.

Incomplete deliveries must be addressed in writing within two weeks to your responsible representative or directly to the head office in Eppingen.



***Observe the two-week deadline***

*Complaints received later will not be recognised.*

---

### 13 Storage

Observe the minimum and maximum values for external conditions such as temperature and humidity according to Chapter "18 Specifications".

Protect the instrument from corrosive or organic solvent vapours, radioactive radiation and strong electromagnetic radiation.

Store the device in the original packaging.

- ➡ To store the device, remove the batteries.

### 14 Transport

Protect the NivuLink Micro II from strong impacts, blows, shocks or vibrations by using appropriate safety measures.

Transport the device in the original packaging.

Otherwise, the same conditions apply with regard to external influences as for storage (see Chap. "13 Storage").

## 15 Return

In the event of a return, send the unit to NIVUS GmbH in Eppingen carriage paid and in the original packaging.

Items that have not been sufficiently franked will not be accepted!

In general, a return note (incl. RMA return number) must be requested from the NIVUS customer service before returning the goods. Without this RMA number, the incoming goods cannot be assigned accordingly.

⇒ See Chap. "44.3 Customer Service Information".

---

### CAUTION



***Returning the data logger with inserted/defective LiSOCl<sub>2</sub> batteries is not permitted***

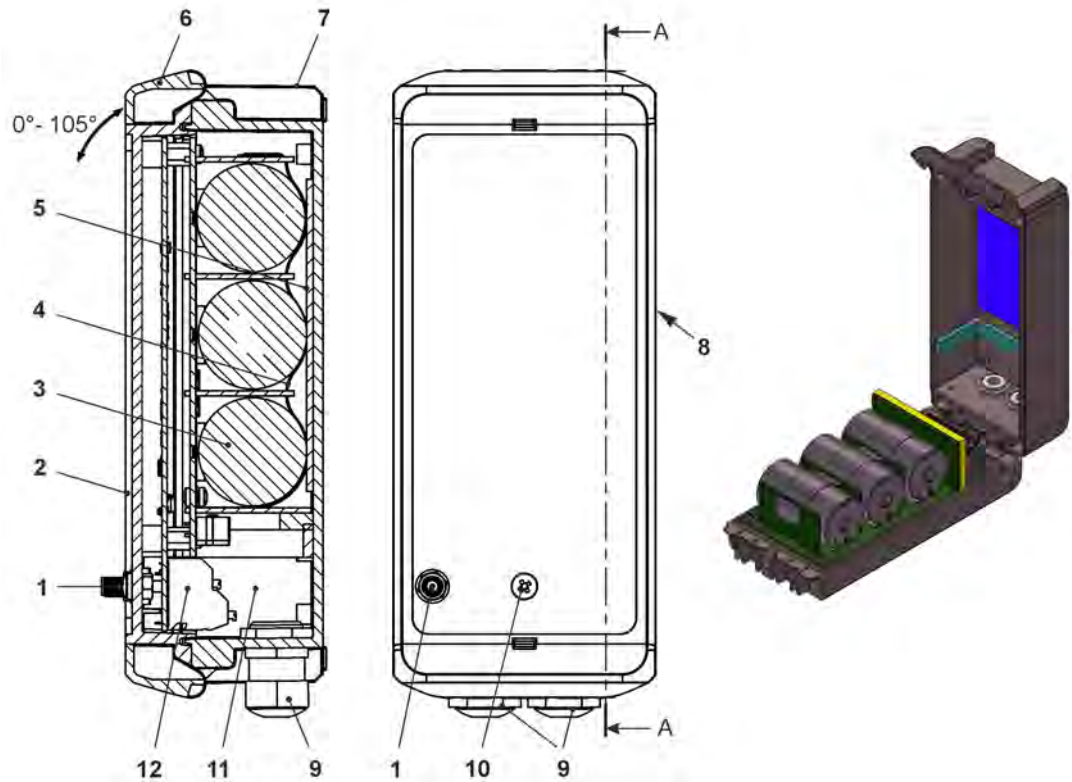
*If the data logger is to be sent to NIVUS for inspection, then only without batteries. Remove the batteries from the battery holder beforehand.*

*As a general rule, defective batteries must not be shipped individually or in a battery holder in accordance with the Dangerous Goods Regulations (DGR) 61st edition 2020 UN 3090 / 3091 Lithium Metal Batteries A154.*

---

## Product Description

### 16 Product Construction and Overview



- 1 2G/3G/4G Antenna socket
- 2 Enclosure flap (max. opening angle 105°)
- 3 Batteries (3 pcs.)
- 4 Eyelet strap for securing the batteries (when the enclosure flap is open)
- 5 Sponge rubber, soft
- 6 Enclosure lock
- 7 Enclosure (IP68 with closed enclosure flap)
- 8 Reed contact (wake-up via magnet)
- 9 Cable gland M16 (2x)
- 10 LED (status display)
- 11 Terminal compartment
- 12 Terminal block 18 poles

**Fig. 16-1 Device construction NivuLink Micro II with enclosure**

### 16.1 Enclosure dimensions

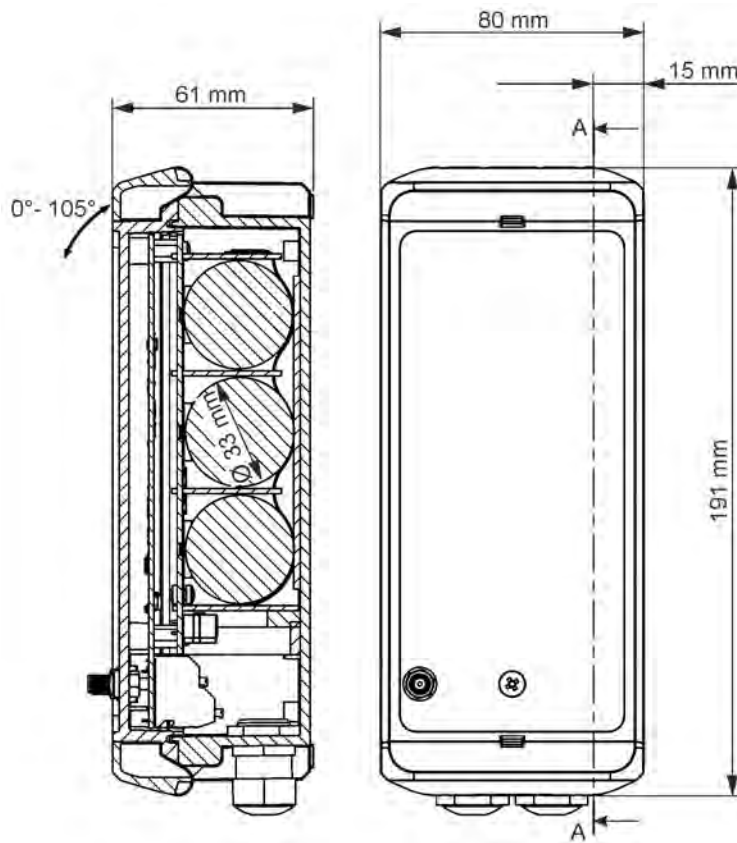


Fig. 16-2 Standard enclosure

## 16.2 Connectable Sensors/Probes

In the following illustration you will find an overview of the connectable level sensors/probes.



- 1 NivuBar Plus II
- 2 NivuBar G II
- 3 NivuBar H III
- 4 HydroBar G II
- 5 AquaBar II
- 6 AquaBar BS
- 7 UniBar E II (with display)
- 8 UniBar E II
- 9 i-Series i-15
- 10 i-Series i-10
- 11 i-Series i-6
- 12 i-Series i-3

**Fig. 16-3 Connectable Sensors/Probes**

## 17 Device ID

### 17.1 Nameplates NivuLink Micro II

The information in this instruction manual only applies to the device indicated on the title page. The nameplates are attached to the side of the enclosure and contain the following information:

- Name and address of NIVUS GmbH
- CE label
- Marking of the series and type with article number and serial number
- Year of manufacture: the first four digits of the serial number refer to the year of manufacture and the week number (2218.....)
- Ex Protection Label
- Ambient conditions in operation

It is important for all queries and spare parts orders that the article number and serial number of the respective device are specified correctly. This is the only way to ensure proper and fast processing.



Fig. 17-1 Nameplate (Part 1) NivuLink Micro II (Example Ex Device)



Fig. 17-2 Nameplate (Part 2, only for Ex Devices) NivuLink Micro II





**Check nameplates**

Check by means of the nameplates whether the supplied device corresponds with your order.

➡ The EU Declaration(s) of Conformity and the EU Type Examination Certificate can be found at the end of this instruction manual.

## 18 Specifications

### 18.1 NivuLink Micro II

<b>Measurement Principles</b>	4-channel data logger (4x universal input)
<b>Power Supply</b>	- Internal: 3x battery Li-SOCl <sub>2</sub> , 3.6 V, size D (s. a. Chap. "47.1 Battery Replacement") - External (only non-Ex device): 5...15 V DC
<b>Enclosure</b>	- Material: Polycarbonate (PC) - Weight: approx. 350 g (incl. batteries) - Protection: IP68 closed / IP67 with open enclosure flap - Dimensions see Chap. "16.1 Enclosure dimensions"
<b>Ex Approvals / other Approvals</b>	ATEX: TÜV xx ATEX xxxxx X  II 2G Ex eb ib [ib] mb IIB T4 Gb  IECEX: TUNxx.xxxxx  Ex eb ib [ib] mb IIB T4 Gb
<b>Operation Temperature</b>	Non-Ex device: -20...+80 °C (device without batteries) Ex Device: -20 °C ≤ T <sub>a</sub> ≤ +50 °C It is essential to observe the corresponding instructions/recommendations of the manufacturers of the batteries used.



<b>Storage Temperature</b>	-30...+80 °C (device without batteries)
<b>Max. Humidity</b>	90 %, non-condensing
<b>Indication</b>	Status LED (RGB) for indicating the operating status
<b>Operation</b>	Magnetic switch for starting a time-limited online connection; via Micro-USB with notebook or PC
<b>Inputs</b>	4x 0...20 mA / 0...10 V / digital universal input  Connection values see Chap. "28.1 Terminal Wiring"
<b>Outputs</b>	1x Micro-USB for read-out of measurement values via Micro-USB cable 1x Relay output 100 mA / 26 V  Connection values see Chap. "28.1 Terminal Wiring"
<b>Storage Cycle</b>	1 min. to 24 hrs., time-cyclical or event-dependent; the possible transmission cycles may differ; details in the respective chapters
<b>Data Memory</b>	Internal; 182,398 measurement cycles
<b>Interfaces</b>	RS485 / Modbus RTU / HART
<b>Data Transmission/ Communication</b>	- Direct connection to notebook/PC via plug-in Micro-USB cable - Via 2G/3G/4G

**Tab. 2 Specifications NivuLink Micro II**

## 18.2 Sensors

The structure and description of the associated sensors as well as their technical data can be found in the corresponding instructions or technical descriptions.

## 19 Equipment/Device Versions

### 19.1 Product Structure

The portable data logger is manufactured in different versions. The table below provides an overview on the currently available different versions.

The version determines the article number. The article number can be found on the name-plate.

Conversely, the exact equipment/device version can be specified on the basis of the article number.

<b>NLG02</b>	NivuLink Micro II					
	Telecontrol gateway with 2G/3G/4G module for transmitting and storing analogue and digital signals; switchable sensor supply; counter function in sleep mode; integrated temperature sensor, incl. rod antenna					
	<b>Number of inputs</b>					
	<b>1</b>	1 Input				
	<b>4</b>	4 Inputs				
	<b>Remote Data Transmission</b>					
	<b>G</b>	With internal modem; modem card Global <sup>*1</sup>				
	<b>Power Supply</b>					
	<b>B</b>	Batteries (in battery holder)				
	<b>O</b>	None (empty battery holder, for customer batteries) (planned)				
<b>Version/Enclosure</b>						
<b>S</b>	Standard Enclosure					
<b>ATEX Approval</b>						
<b>E</b>	Ex zone 1					
<b>0</b>	None					
<b>Options</b>						
<b>00</b>	None					
<b>NLG02</b>						

<sup>\*1</sup> Areas of use: Global

**Tab. 3 Product Structure**



Accessories see Chapter "48 Accessories".

### 19.2 Add-On Function Licences

The data logger can be equipped with supplementary functions at extra charge. The following function extensions are currently available as (software) licences:

- FTP/SMTP client for data transmission via FTP server (*NFM LIZENZ FTP*), see Chap. "41.1.8 FTP (only with licence)" and "41.1.9 / E-Mail (only with licence)"
- Data transmission extended to determine the data depth (*NFM LIZENZ ERW*) see Chap. "39.2 Menu Data Memory": **>Data Depth<**
- Data transmission expert to determine the data depth (*NFM LIZENZ EXP*) see Chap. "39.2 Menu Data Memory": **>Data Depth<**



The functions are activated according to Chap. "40.5.5 Feature Unlock".

## Function Description

### 20 Functional Principle

The NivuLink Micro II is a compact, portable device for detecting, processing, storing and transmitting analogue or digital signals captured via various industrial interfaces. Up to four universal inputs are available, which can be operated in different analogue or digital modes. The measurement data of the inputs are temporarily stored in an internal data memory together with the states of the outputs. The stored data is transmitted wirelessly (2G/3G/4G) to a central server such as the NIVUS WebPortal at a freely selectable interval.

This server can be accessed directly with a client on which a web browser is installed.

The integration of higher-level control systems, supplementary data sources such as geoinformation or analysis systems as well as operating software for billing purposes are realised via NIVUS DataKiosk.

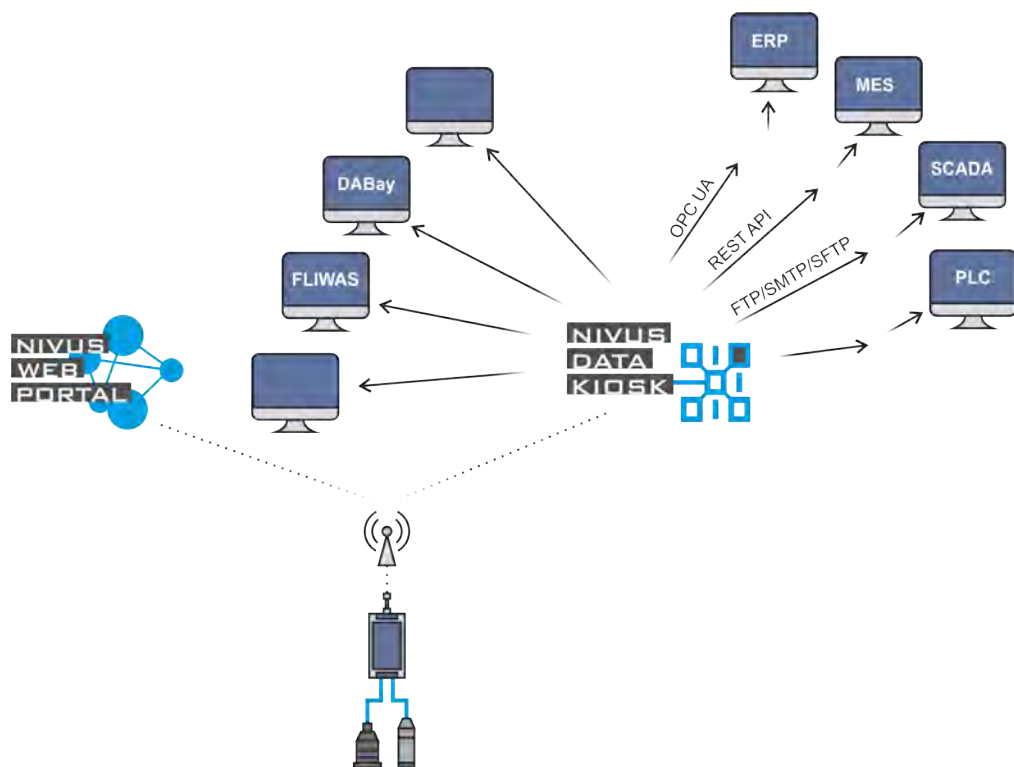


Fig. 20-1 Functional principle of the NivuLink Micro II

## Installation and Connection

### 21 General Installation Information

---

**WARNING****Check danger due to explosive gases**

Before starting assembly, installation and maintenance work, be sure to check that all regulations on safety at work have been observed and that there is no possible risk of explosive gases. Use a gas warner for the check.

When working in the sewer system, make sure that no electrostatic charge can occur:

- Avoid unnecessary movements to reduce the building-up of static charges.
- Discharge any static electricity present on your body before you start installing the sensor.

Disregarding may result in personal injury or damage to the system.

---

#### 21.1 Mounting Place

The following precautions must be taken at the mounting place for safe installation:

- ➡ Protect the data logger from direct sunlight. If necessary install a sunshade.
- ➡ Observe the permissible ambient temperature (see Chap. "18 Specifications").
- ➡ Do not expose the data logger and the connected sensors to strong vibrations or mechanical shocks.

**Necessarily avoid when selecting the mounting place:**

- Corrosive chemicals or gases
- Radioactive radiation
- Installation close to footpaths or travel ways

#### 21.2 Gaskets

- ➡ Check the gaskets on the enclosure flap.  
Before closing the enclosure flap, always make absolutely sure that the gasket is clean and undamaged. Therefore:
  - Remove foreign bodies and dirt.
  - Replace defective gaskets.
  - Treat the seals with silicone grease if necessary.

**Gaskets**

Damage to equipment caused by leaking or defective gaskets shall be excluded from the liability of the companies of NIVUS GmbH.

---

- ➡ See also Chap. "44.2 Maintenance Tasks".

## 21.3 Cable Glands

- Close open, unused cable glands on the underside of the data logger with the sealing plugs to protect against dirt or penetrating liquids before installation.

The protection class of the closed device is IP68.

Damaged or lost sealing plugs can be reordered from NIVUS at extra costs.

## 22 Open / Close the Data Logger Enclosure



Fig. 22-1 Open / close enclosure

- Procedure to **open** the enclosure:

### CAUTION



#### **Equipment damage due to water**

*If you open the enclosure flap in the rain or in a location with potential water ingress from above, be sure to **protect** the NivuLink Micro II in a suitable manner against the ingress of moisture.*

1. If the NivuLink Micro II is supplied with external voltage, disconnect it.
2. Release lock (Fig. 22-1 Pos. 1).
3. Carefully fold down the housing flap (Fig. 22-1 Pos. 2) to protect the hinge (do not drop it).

- Procedure to **close** the enclosure:

1. Check the enclosure gaskets according to chapter "21.2 Gaskets" and clean if necessary.
2. Fold up the enclosure flap (Fig. 22-1 Pos. 2) and close the lock (Fig. 22-1 Pos. 1).
3. If necessary, switch on the external power supply again.

## 23 Fastening the Data Logger

The following variants are possible for fastening the NivuLink Micro II:

- Enclosure rear panel mounted on a mounting plate (3 mm thick); mounting plate screwed to a flat surface (wall or similar) (drilling pattern see Fig. 23-1 Pos. 1)
- Directly screwed to a flat surface (wall or similar) with the rear panel of the enclosure (drilling pattern see Fig. 23-1 Pos. 2)
- Enclosure rear panel mounted on a mounting plate (3 mm thick); mounting plate fixed to a mast (see Fig. 23-2) with clamps (openings see Fig. 23-2 Pos. 1)
- Enclosure rear panel mounted on a mounting plate (3 mm thick) with bracket for hanging on the step iron in a shaft (see Fig. 23-3)

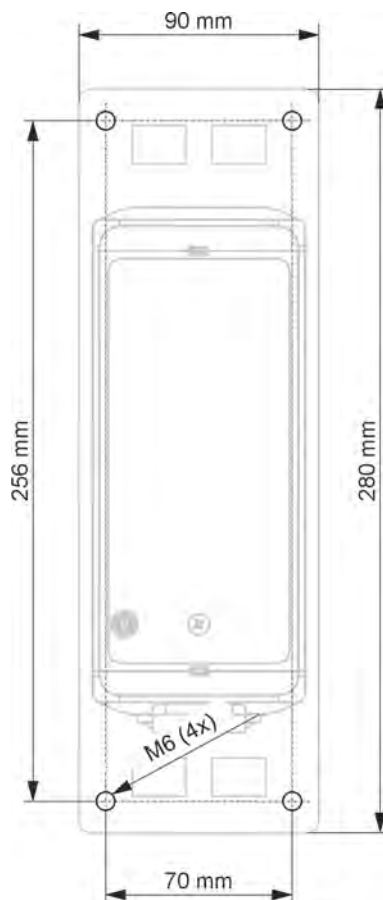
➡ See also Chap. "48 Accessories".



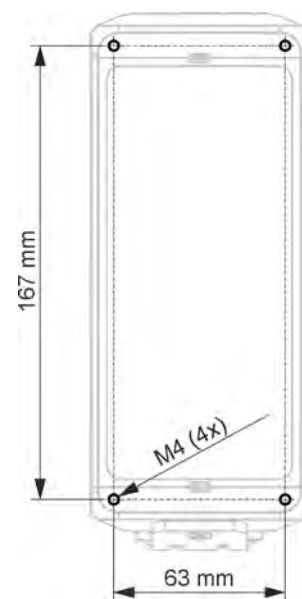
### Note

*Tools and fastening materials are not included in the delivery.*

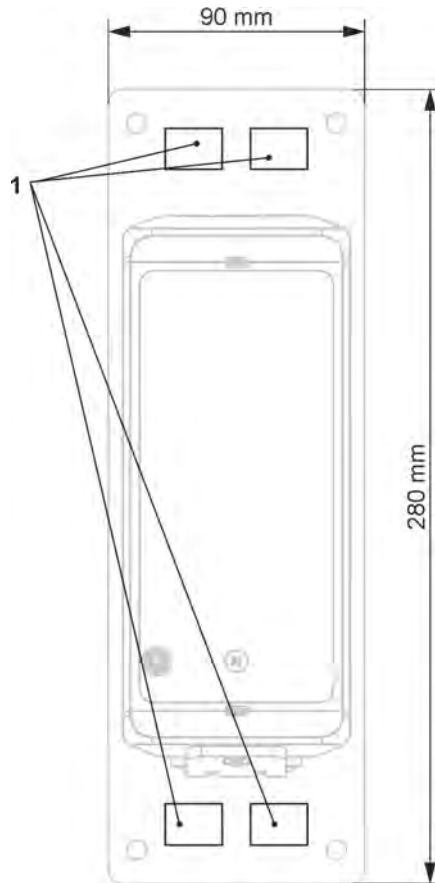
**Fastening with Mounting Plate**



**Fastening directly on a Wall**

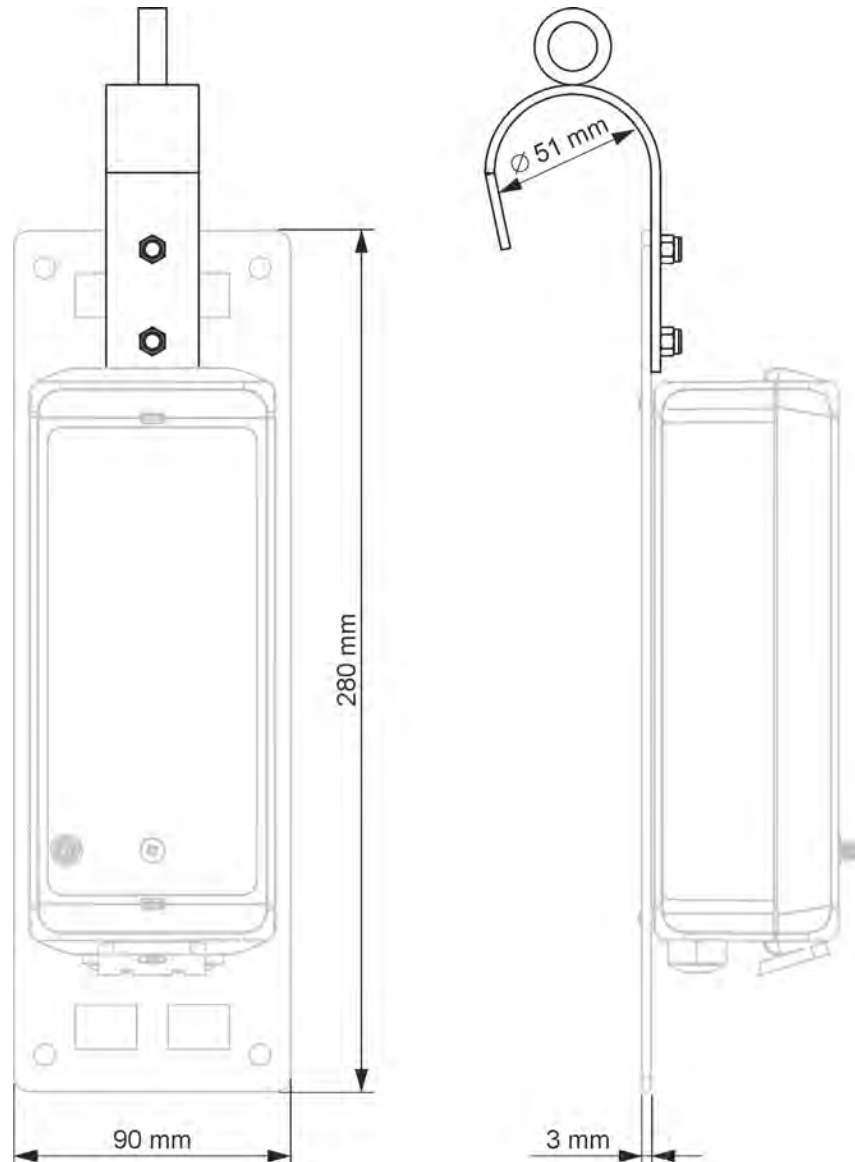


**Fig. 23-1 Fastening drilling patterns**



---

**Fig. 23-2** Fastening on a mast using clamps



**Fig. 23-3 Fastening with bracket on step iron**



**Allow enough space for antenna and cable connections**

*Before final fixing, be sure to allow sufficient space/clearance for the mounting of the antenna (front of the device) and the cable connections (below at least 15 cm).*

➤ Procedure:

1. Outside the Ex area, insert the SIM card as described in Chapter "24 Prepare, insert / change SIM card".
2. Outside the Ex area, screw on the antenna as described in Chapter "25 Antenna Installation".
3. For wall mounting, transfer the respective drilling pattern (see Fig. 23-1) to the wall and drill the holes.
4. If necessary, open the enclosure according to chapter "22 Open / Close the Data Logger Enclosure" (flap downwards to the front).



5. Screw the enclosure to the wall or fasten the data logger to the mounting plate (if necessary, also the bracket; Fig. 23-3).
6. Connect sensors according to Chap. "27 Installation of Sensors" and "28 Connection of Sensors" through the cable glands.
7. If one of the cable glands was not needed, close it with a suitable sealing plug to ensure the protection class of the data logger.
8. Close the enclosure according to Chap. "22 Open / Close the Data Logger Enclosure".
9. If necessary, attach the holder to the mast with clamps or hang it on the step iron in the shaft.

## 24 Prepare, insert / change SIM card

### 24.1 Activate PIN

Optionally, you can activate the PIN of the SIM card before inserting it into the data logger.



#### **Preventing unauthorised use**

*Activate PIN to prevent unauthorised use of the SIM card in case of theft.*

➡ Procedure:

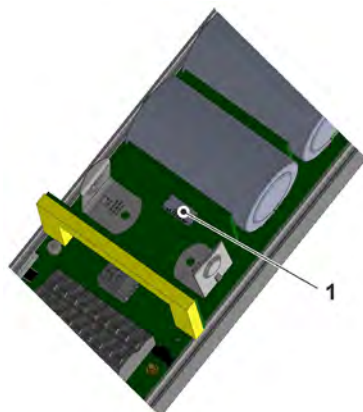
1. Insert the SIM card into a mobile phone.
2. Activate PIN.
3. Remove the SIM card from the mobile phone.  
The PIN is activated and is required for parameterisation.

### 24.2 Insert / change SIM card in the data logger

**The SIM card must be inserted into the data logger outside the Ex area, as the batteries must be removed for this and this is not permitted in the Ex area.**

➡ Procedure:

1. Open the NivuLink Micro II enclosure according to Chap. "22 Open / Close the Data Logger Enclosure".
2. Remove the batteries from the battery holder according to Chap. "47.1 Battery Replacement".  
The SIM card slot (Fig. 24-1 Pos. 1) is accessible.



**Fig. 24-1 SIM card slot**

3. If present, remove the previous SIM card.
4. Insert the SIM card into the card holder so that its contacts face the board.
5. Insert the batteries according to Chap. "47.1 Battery Replacement".
6. Close the enclosure according to Chap. "22 Open / Close the Data Logger Enclosure".

## 25 Antenna Installation



**Please note:**

*Only install antennas approved / recommended by NIVUS.*

*The mobile phone antenna must be positioned to ensure that no person is permanently (longer than 6 minutes) at a distance of less than 25 cm from the antenna.*

*When the device is operating normally, there is usually no health risk even at smaller distances, as the device only transmits for a short time on the mobile radio interface, but this distance should still be observed as a precautionary measure.*

*The antenna must not extend beyond the lightning-protected area of buildings and must be protected against lightning strikes.*

The antenna is simply screwed onto the front of the NivuLink Micro II.

## 26 Electrical Installation/Power Supply

### 26.1 General Information on the Power Supply

**WARNING**



**Danger by electric voltage**

*Remove the batteries from the device.*

*If the data logger currently is connected to the mains, disconnect it.*

*When working on the electrical connections, there is a risk of electric shock. Observe the electrical data given on the nameplate.*

*Disregarding may lead to personal injury.*

**CAUTION**



**Equipment damage due to weather influences**

*If water enters the enclosure, the data logger may be **damaged**.*

*If you open the enclosure flap in the rain or in a location with potential water ingress from above, be sure to **protect** the NivuLink Micro II in a suitable manner against the ingress of moisture.*

*Do **not** operate the data logger with the enclosure flap open.*



**Note**

*Observe the national installation instructions.*

➡ Make sure that the following requirements are met:

1. Please note that installation may only be carried out by qualified personnel.
2. For the electrical installation, comply with the legal regulations of the respective country (such as VDE 0100 in Germany).

3. Follow further (country-specific) legal standards, regulations and technical codes.
4. Complete the installation of the data logger and the sensors before applying the operating voltage. Check whether the installation is correct.

⇒ You can find a description on how to connect the sensors starting on page 36.

---

## CAUTION



### **Do not loosen screws**

*Do not loosen any screws inside the data logger!*

**Keep the enclosure flap closed during operation.**

---

## 26.2 Removing/installing the batteries

---

### WARNING



### **Risk of explosion when removing/installing the batteries in Ex areas**

*Batteries may only be removed/installed and charged **only outside** the Ex area. **Never within** Ex areas.*

*When the batteries are removed, make sure that the poles are not short-circuited by an external object. This could cause very high short-circuit currents to flow, which could lead to excessive heat or fire and destruction of the batteries.*

*Observe the specifications on the batteries.*

---



### **Installation of Spare Parts / Wearing Parts**


*The use of spare/wear parts (e.g. batteries) that are not approved by NIVUS is generally not permitted.*

*Non-compliance may have negative consequences in terms of warranty and liability. See Chap. "5 Warranty" and "6 Disclaimer".*

---



### **The following applies to the use of batteries:**

- *All batteries used at the same time must be date stamped together by the manufacturer and must be new.*
  - *The replacement of individual batteries is not permitted.*
  - *Strict attention must be paid to the correct orientation of the batteries when inserting them.*
  - *All batteries must bear the  mark.*
- 

⇒ Procedure for removal/installation see Chap. "47.1 Battery Replacement" starting on page 95.

⇒ Batteries are available from NIVUS at extra costs (see Chap. "48 Accessories").

## 27 Installation of Sensors

This chapter describes the sensors that can be used and their usual locations. The exact description for mounting the sensors is included in the relevant (mounting) instructions.



### Note

*During assembly work, ensure that all work safety regulations are observed.*

### 27.1 Sensor Installation Principles

The placement of the sensors on the system is decisive for the reliability of the measurement results. Therefore, care must be taken to ensure good hydraulic conditions and a sufficient calming section at the installation site. The sensor types and their mounting must be determined individually, depending on the measuring point.



The conditions for selecting a calming section and mounting the sensors are described in the respective (mounting) instructions.

The measurement place or the inputs must be parameterised **before installation**. The corresponding preparation of the measurement place and its dimensions/key data can be taken from the documents of the respective facility or can be requested from the facility operator.

### WARNING



### **Danger of explosion when opening the unit and plugging in the USB cable**

*The device may be opened **only outside** the Ex area.  
**Never within** Ex areas.*

*This also means that the USB cable for parameterising the NivuLink Micro II cannot be plugged in and the parameterisation cannot be carried out.*

## 28 Connection of Sensors / the Rain Gauge

### 28.1 Terminal Wiring

X1	1	2	3	4	5	6	7	8	9
	NO	COM	Rx+	PWR CH0	IN CH0	GND	PWR CH1	IN CH1	GND
	NC	GND	Rx-	PWR CH2	IN CH2	GND	PWR CH3	IN CH3	GND
	10	11	12	13	14	15	16	17	18

Fig. 28-1 Terminal wiring X1 on NivuLink Micro II

Name	Connection pin	Connection values
Relay - Output	X1.1 (Rel-NO), X1.2 (Rel-COM), X1.10 (Rel-NC)	$U_i = 26 \text{ V}$ ; $I_i = 100 \text{ mA}$ ; $P_i = 2.6 \text{ W}$ $C_i = 0$ ; $L_i = 0$

RS485 Interface	X1.3 (RxTx+), X1.11 (GND), X1.12 (RxTx-)	U <sub>o</sub> = 5.88 V; I <sub>o</sub> = 150.1 mA; P <sub>o</sub> = 221.9 mW Characteristic: linear  U <sub>i</sub> = 7.21 V; I <sub>i</sub> = 176 mA; P <sub>i</sub> = 317.24 mW C <sub>i</sub> = 0; L <sub>i</sub> = 0
Universal input 0	X1.4 (CH0_PWR) X1.5 (CH0_IN) X1.6 (GND)	U <sub>o</sub> = 25.09 V; I <sub>o</sub> = 90.9 mA; P <sub>o</sub> = 570 mW Characteristic: linear
Universal input 1	X1.7 (CH1_PWR) X1.8 (CH1_IN) X1.9 (GND)	U <sub>o</sub> = 25.09 V; I <sub>o</sub> = 90.9 mA; P <sub>o</sub> = 570 mW Characteristic: linear
Universal input 2	X1.13 (CH2_PWR) X1.14 (CH2_IN) X1.15 (GND)	U <sub>o</sub> = 25.09 V; I <sub>o</sub> = 90.9 mA; P <sub>o</sub> = 570 mW Characteristic: linear
Universal input 3	X1.16 (CH3_PWR) X1.17 (CH3_IN) X1.18 (GND)	U <sub>o</sub> = 25.09 V; I <sub>o</sub> = 90.9 mA; P <sub>o</sub> = 570 mW Characteristic: linear

**Tab. 4 Connection values of clamps on NivuLink Micro II**

## 28.2 Cable for Sensor Connection

The sensors are supplied with permanently connected cables. On the data logger side with open cable ends. Depending on the sensor, these are connected directly to the terminal block of the data logger.

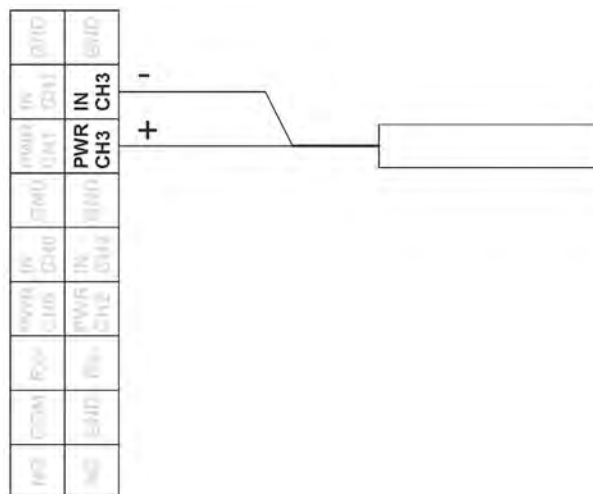
The sensors can be ordered with cables of different lengths.

## 28.3 Connecting Sensors

List of connectable sensors see Chapter "16.2 Connectable Sensors/Probes".

The sensors are connected to terminal block X1 inside the data logger. To do this, insert the cables into the enclosure through the cable glands on the underside of the NivuLink Micro II.

### Wiring Examples:

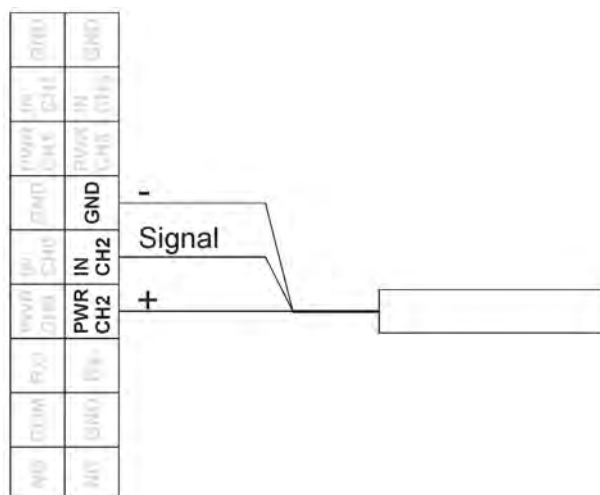


**Fig. 28-2 Connecting a 2-wire sensor**

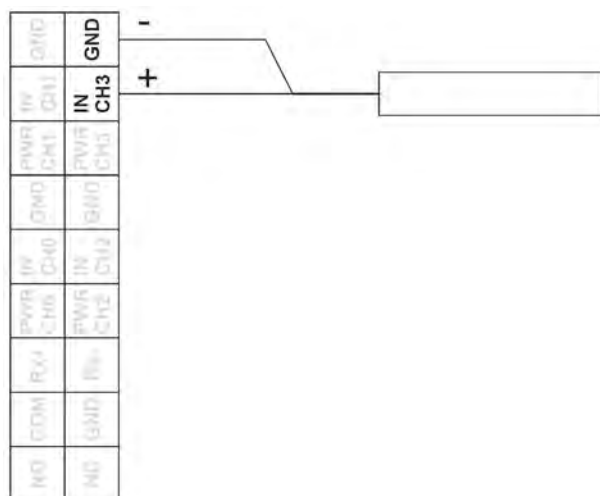


**HART Functionality available**

The CH2 connection (for input 3) also has HART functionality for i-Series sensors by NIVUS.



**Fig. 28-3 Connecting a 3-wire sensor**



**Fig. 28-4 Connecting an active or passive signal transmitter**

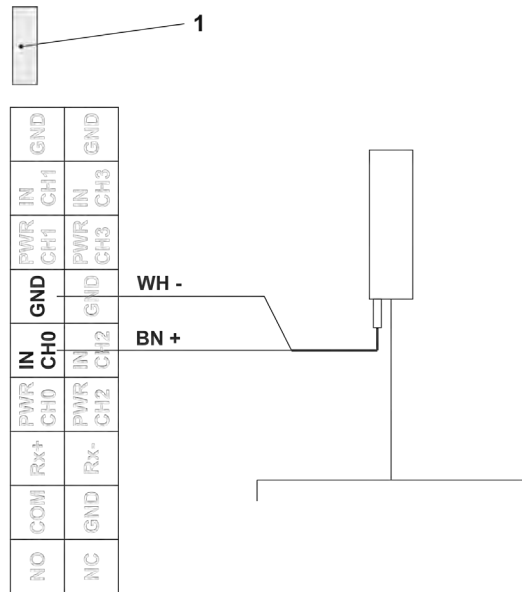
## 28.4 Connecting the Rain Gauge

To connect the NivuLink Micro II to a rain gauge RMT0, use the cable *ZUB0 KAB RM NLG* (one side with plug, other side with open cable ends).

The Rain Gauge is connected to terminal block X1 inside the data logger. To do this, insert the cable into the enclosure through the cable glands on the underside of the NivuLink Micro II.

 Procedure:

1. Plug the enclosed jumper (short circuit bridge) (Fig. 28-5 Pos. 1) onto the two empty pins next to the terminal strip.
2. Connect the brown and white wires to the terminal strip according to Fig. 28-5. The two remaining wires (green and yellow) are not used.



**Fig. 28-5 Connecting a Rain Gauge**

3. Insert the plug of the cable on the Rain Gauge and screw it tight.



For parameterisation for using the rain gauge, see Chap. "38.2 Menu Inputs":  
**Impulse Counter.**

## Commissioning

### 29 Notes to the User

Before connecting and operating the NivuLink Micro II the instructions below shall be followed.

This instruction manual contains all information required for parameterisation and use of the data logger. The instruction manual is intended for qualified expert personnel. Appropriate knowledge in the areas of measurement systems, automation technology, control engineering, information technology and wastewater hydraulics are preconditions for putting the NivuLink Micro II into operation.

Read this instruction manual carefully to ensure proper functioning of the NivuLink Micro II. Connect the NivuLink Micro II according to Chapter "28.3 Connecting Sensors".

If you have any questions regarding installation, connection or parameter setting, please contact our hotline at:

- +49 7262 9191-955

#### General Principles

Commissioning of the measurement system shall not be carried out before installation has been finished and verified.

The measurement place or the inputs must be parameterised **before the installation** of the data logger.

#### WARNING



#### ***Danger of explosion when opening the unit and plugging in the USB cable***

*The device may only be opened **only outside** the Ex area.  
**Never within** Ex areas.*

*This also means that the USB cable for parameterising the NivuLink Micro II cannot be plugged in and the parameterisation must be carried out before the installation of the data logger.*

Observe the information in this instruction manual to prevent incorrect or faulty or parameterisation. Familiarise yourself with the operation of the data logger before you start with the parameterisation.

To set the parameters of the measurement place, in most cases it is sufficient to enter:

- Definition of inputs (type)
- Display units
- Operation mode settings

The user interface of the NivuLink Micro II is easy to understand. You can quickly make the basic settings yourself.



### 30 Lighting System of the Status LED on NivuLink Micro II

The status LED (Fig. 30-1) on the front of the NivuLink Micro II lights up during operation according to a predefined system that allows conclusions to be drawn about the current status of the device.



**Fig. 30-1 LED on the front of the NivuLink Micro II**

A distinction is made here primarily according to the operating condition. When the data logger is "awake", it acts differently than in shutdown mode.


















































- **Awake:**

The sequence consists of a total of twelve light segments.

First there is a long (1.5 s) coloured light of the LED indicating the status of the modem, then a short (0.5 s) pause followed by a short (0.5 s) coloured light for each of the four inputs and for the entire system (i.e. a total of five short pauses/lighting phases). After a long pause (1.5 s), the sequence starts again.

**Explanation** of the following table of possible light combinations:

- LED oval means 1.5 s active (on or off)
- LED round means 0.5 s active (on or off)
- Green stands for "Correct" (everything is in order)
- Red stands for "Error" (the affected element does not work as it should)
- Magenta/pink, blue or yellow stands for a special message
- Grey is a placeholder for one of the other colours and must be considered individually in the overall sequence, as not all possible variants are shown in the table below.

Modem		Input 1		Input 2		Input 3		Input 4		System	
											
ok		ok		ok		ok		ok		ok	
											
Err.		Err.		Err.		Err.		Err.		Err.	
											
Going online		ok / Err.		ok / Err.		ok / Err.		ok / Err.		ok / Err.	
											
Online		ok / Err.		ok / Err.		ok / Err.		ok / Err.		ok / Err.	
		Test transmission triggered <sup>1)</sup>									

<sup>1)</sup> Hold the magnet against the reed contact for approx. 10 s to trigger a test transmission; note that the online mode is started after approx. 15 s; if this is not desired, remove the magnet in good time before the 15 s have elapsed

**Tab. 5 Lighting system of the status LED in the awake condition**

















- **Shutdown mode:**

This sequence consists of a total of four light segments.

First there is a short (0.5 s) coloured light of the LED indicating the status of the system/modem, then a short (0.5 s) pause each time followed by a short (0.5 s) coloured light for the status of the events. After a short pause (0.5 s), the sequence starts again.

**Explanation** of the following table of possible light combinations:

- LED round means 0.5 s active (on or off)
- Green stands for "Correct" (everything is in order)
- Red stands for "Error" (the affected element does not work as it should)
- Magenta/pink, blue or yellow each stand for a special message
- Grey is a placeholder for one of the other colours and must be considered individually in the overall sequence, as not all possible variants are shown in the table below.

System / Modem	Event		
 ok		 No event	
 Err.		 Event	
 Going online		 Event / no event	
 Online		 Event / no event	

Tab. 6 Lighting system of the status LED in shutdown mode

## 31 Connection Setup

### 31.1 Common

The entire operation of the NivuLink Micro II is carried out via notebook or PC (using the NIVUS WebPortal if necessary).

The procedure for establishing a connection for the Windows operating systems is described below.

### 31.2 Windows Operating System

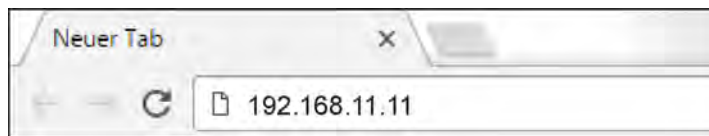
➡ Procedure:

1. Start the notebook or PC.
2. Ensure power supply at the NivuLink Micro II.
3. Open the NivuLink Micro II enclosure according to Chap. "22 Open / Close the Data Logger Enclosure".
4. Plug the USB cable into the NLG02 and the notebook/PC.
5. "Wake up" the NLG02: To do this, hold the supplied magnet in front of the reed contact (Fig. 31-1 Pos. 1; at the front of the NLG02) until the LED (Fig. 31-1 Pos. 2) lights up.



**Fig. 31-1 Waking up the NivuLink Micro II**

6. Start Internet browser.



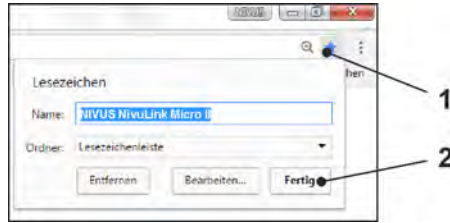
**Fig. 31-2 Address field**

7. Enter the IP address "192.168.11.11" in the address field (Fig. 31-2) and open.
8. Enter user name and password (see sticker enclosed ex works)  
After successful connection the display of the NivuLink Micro II (Fig. 31-3) is shown.



**Fig. 31-3 Indication of NLG02 display in the browser**

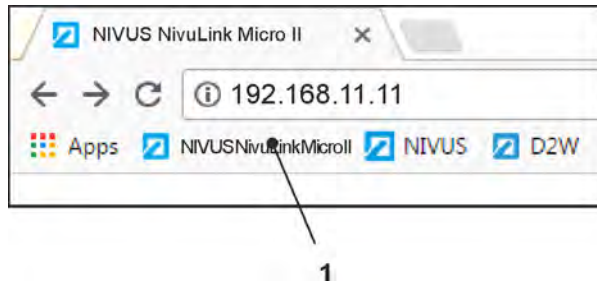
9. To set up a favourite in the browser (for direct access), tap the star for "Favourites" (Fig. 31-4 Pos. 1) (Google Chrome is used as an example) and confirm with "Done" (Fig. 31-4 Pos. 2).



**Fig. 31-4 Setting up favourite**

The bookmark appears on the bookmark bar (Fig. 31-5 Pos. 1) and can be used for immediate access by simply selecting it without entering the IP address.

This link can also be used with any other NivuLink Micro II unit after the respective selection in the WLAN list.



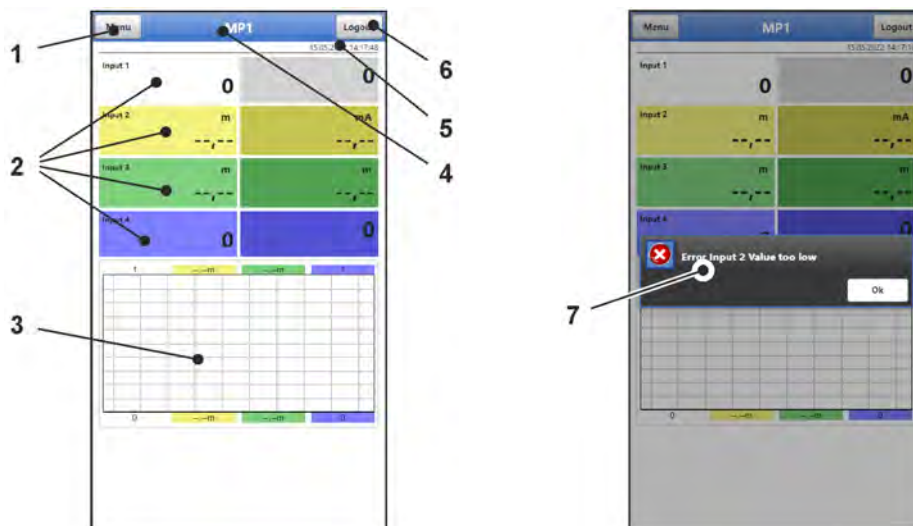
**Fig. 31-5 Link in the bookmarks bar**

## 32 Menu Control/Overview

### 32.1 Overview Display

Via the NIVUS display you can see at any time where you are in the menu and which entries you are currently editing.

➡ See also Chap. "Main Screen" starting on page 48.



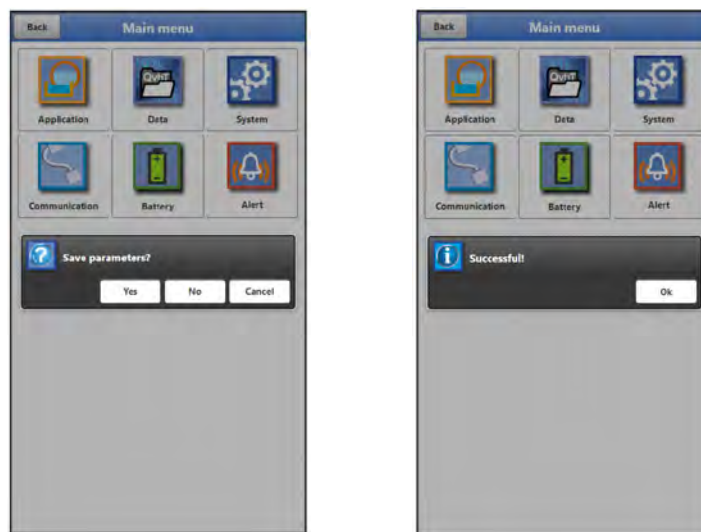
- 1 Menu / Back (depending on the display view)
- 2 Display area (output field 4...8 for input 1...4)
- 3 Display area 3 (trend hydrograph of input 1...4)
- 4 Name of the measurement place
- 5 Date and Time

- 6 Logout (disconnecting the notebook/PC from the data logger; the data logger continues to run with the last saved settings)
- 7 Possible error message, information or display for active service mode (one-time display, directly after opening as a separate window in the centre of the display; close with "Ok")

**Fig. 32-1 Display view**

## 32.2 Save Parameters

After changing parameters and scrolling back via the menu field, the changed parameters must be saved before the changes take effect. After saving, the status message "Successful" appears (Fig. 32-2).



**Fig. 32-2 Save parameters**

- ➡ Procedure for saving see Chapter "36.1 Save Parameters".

### 32.3 Menus

All menus are described in a logical programming sequence in chapter "Setting Parameters" starting on page 51.

There are six basic menus available in the main menu. These become visible and selectable by selecting the "Menu" field (from the main display) or the "Back" field (from within the sub-menus).

In detail these are:

<b>Application</b>	Guides commissioning personnel through the complete parameterisation of inputs, digital output and diagnostics
<b>Data</b>	<ul style="list-style-type: none"> <li>- Graphical representation of the measurement values history</li> <li>- Saving of data</li> <li>- Saving and loading of parameters</li> </ul>
<b>System</b>	<ul style="list-style-type: none"> <li>- Retrieval of basic information (serial number, version, item number, etc.) on the data logger (required for queries with NIVUS GmbH)</li> <li>- Setting the language and date format under &gt;Country Settings&lt;</li> <li>- Setting the system time, time zones and time server under &gt;Time/Date&lt;</li> <li>- Indicating and deleting error messages under &gt;Error Messages&lt;</li> <li>- Service Levels</li> <li>- Restarting the data logger</li> <li>- Shut Down Device (Powerdown)</li> <li>- Parameter Reset</li> <li>- Feature Unlock</li> <li>- Setting the operation mode</li> <li>- etc.</li> </ul>
<b>Communication</b>	Setting parameters for the communication interfaces of the NivuLink Micro II
<b>Battery</b>	Display of the available battery voltage
<b>Alarm</b>	Activate the alarm for errors and set the upper and lower limits/thresholds at which an alarm is sent by e-mail via the NIVUS WebPortal

Tab. 7 Menu overview

## Main Screen

### 33 Functions of the Main Screen

#### Quick Access

In addition to displaying the values themselves, the main screen also allows for direct access to the most important setting parameters.

The quick access enables to directly jump to important individual menus without having to go through the (sub)menus of the parameterisation. It is thus used for a quick and uncomplicated check of the inputs/outputs.

Via the quick access, a quick diagnosis, an uncomplicated parameter adjustment as well as changes in the settings are possible. Direct queries for basic device data such as serial and article number as well as the firmware version of the data logger are also possible in just a few steps.

### 34 General Overview

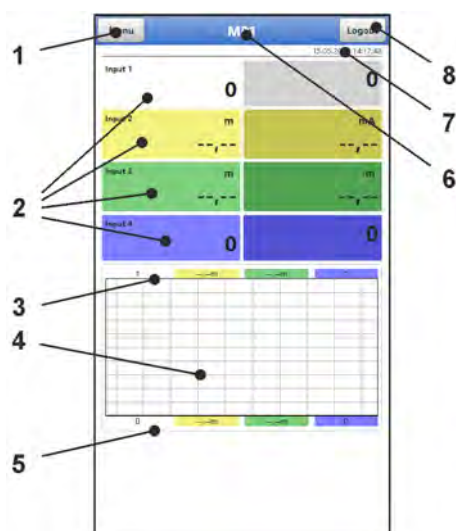
The following information is provided in the **top area** of the display:

- Menu and Logout Icons
- Name of the measurement place
- Date and Time

In operation mode the NivuLink Micro II displays the following important measured values in the **main area**:

- Inputs 1...4

A diagram for the calculated values of inputs 1...4 is shown in the **lower area** of the display (see also Chap. "35.1 Display fields input 1...4").



- 1 Button to open the main menu
- 2 Output fields for the values of inputs 1...4
- 3 Upper scaling range for the diagram
- 4 Diagram for the display of inputs 1...4
- 5 Lower scaling range for the diagram
- 6 Name of the measurement place
- 7 Date and Time



8 Button to log out the notebook/PC

**Fig. 34-1 Main screen overview (example without measurement values)**

A pop-up menu with the most important settings and information can be accessed directly via the fields of the main display with a mouse click (left button). A further mouse click on the selection opens the respective pages and offers the possibility to parameterise or view current states.



**Fig. 34-2 Pop-up menus**



### **Save Parameters**

*After changing system-specific parameters, the changes must be saved for them to take effect.*

## 35 Display Fields

### 35.1 Display fields input 1...4

Two current values are displayed next to each other for all four inputs (depending on the assignment of the inputs). The right field shows the measured raw value, the left field the value calculated from it.

When clicking on the pop-up menus, the data logger opens the following pages (identical on the right and left):

- Settings: >Application< / >Inputs< (always exactly suitable for the corresponding input); see Chapter "38.2 Menu Inputs"
- Diagnostics: >Application< / >Diagnostics< / >Inputs<; see Chapter "38.4 Menu Diagnostics"
- Error Messages: >System< / >Error Messages< / >Active Error Messages<; see Chapter "40.4 Menu Error Messages"

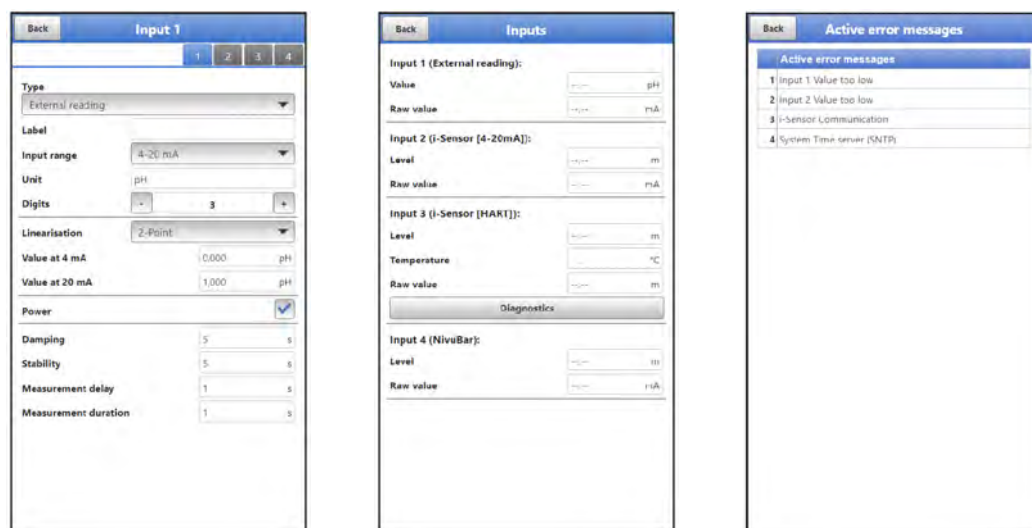


Fig. 35-1 Opened display fields with input 1 – 4 (using input 1 as example)

## Setting Parameters

### 36 General Programming



#### **Setting parameters using the Micro-USB interface**

Both parameterisation and diagnostics can be carried out directly on site with the USB connection cable connected between the data logger and notebook/PC.

To do this, open the enclosure as described in chapter "22 Open / Close the Data Logger Enclosure" and plug the USB cable into the Micro-USB interface (Fig. 2-3 Pos. 5).

In principle, changed parameters do not become effective before they have been saved. When exiting all menus via the "Back" field, the data logger checks whether parameters have been changed. Finally, you are asked whether the parameters should be saved.

- >Yes<: the changed parameter setting is accepted and saved.
- >No<: the changes to the parameters are discarded and the device exits the menus.
- >Cancel<: You exit the query. The parameters remain changed, but are not yet effective and not saved.



#### **Tip for repeated measurement of the same measurement places**

If measuring points are not only measured once but repeatedly, it is recommended to save the parameterisation of the measuring point and, if necessary, also the measurement data on the notebook/PC. During the next measurement at the measuring point in question, these can then be quickly transmitted onto the data logger and there is no need for renewed parameterisation.

See Chapter "39.2 Menu Data Memory" starting on page 66.

#### 36.1 Save Parameters

After entering all necessary (measurement place) parameters, these must be saved to become effective.

➡ Procedure:

1. Select "Back" repeatedly until a window opens with the message >Save Parameters?<. Confirm with >Yes< \*.
- The message "Successful!" indicates the completed saving of the parameters.

\* >Yes< saves the new parameters; >No< cancels the saving process and the last saved parameters are active again; >Cancel< cancels the saving process, the last changed parameters remain active and the initialisation process can be continued.

#### 36.2 Change User Name

The user name is set to "admin" **per default**.

This factory-assigned user name can be changed as described below. The new SSID must have between 8 and 32 characters.

➡ Procedure:

1. Open the main menu via "Menu".
2. Open the >Communication< menu.
3. Open the >HTTP< menu.
4. Select the field >User Name<.
5. Enter the new name and confirm.

### 36.3 Change Password

The password is set **per default** to an individually determined identifier for the device. This password is enclosed with the data logger as a sticker (inside the enclosure) and can be affixed by the user at a location to be determined by him/herself (inside the unit or elsewhere). This factory-assigned password can be changed as described below. The new password must have between 8 and 32 characters.

➤ Procedure:

1. Open the main menu via "Menu".
2. Open the >Communication< menu.
3. Open the >HTTP< menu.
4. Select the >Password< field.
5. Enter the new password and confirm.

Only one user at a time can access the data logger and its parameterisation when using the Micro-USB cable. If several users access the modem at the same time, it is essential to ensure that changes in the parameterisation are made in consultation and that there is no simultaneous access. The last saved parameter is always valid.



---

**Keep your password safe**

*Only give the password to authorised persons.*

*If you write down the password, keep it in a safe place.*

---

### 36.4 Loss of the Password

Each NivuLink Micro II is delivered with a PUK ("Personal Unblocking Key" or also Super PIN). This allows the unit to be reactivated if the password is forgotten and a new password can be assigned.

This PUK is identical to the default password which is attached as a sticker (inside the enclosure). If this sticker cannot be found later, the factory-assigned password can be requested from NIVUS by stating the device serial number.

➤ Procedure:

1. Open the enclosure flap according to Chap. "22 Open / Close the Data Logger Enclosure".
2. Remove the batteries outside the Ex area according to Chap. "47.1 Battery Replacement".
3. If a Micro-USB cable is plugged in, unplug it.
4. Hold the supplied magnet to the Reed contact.
5. Plug in the Micro-USB cable to change the password afterwards.
6. As soon as the LED flashes in the normal rhythm (i.e. as soon as the boot process is completed), the factory-supplied password works again.
7. Enter the new password according to Chapter "36.3 Change Password".
8. If no further parameterisation/diagnostics are to be carried out, disconnect the Micro-USB cable again.
9. Reinsert the batteries.
10. Close the enclosure flap.

## 37 Parameter Functions

### 37.1 Main Menu

The NivuLink Micro II is parameterised via the total of six settings menus.

The individual menus are explained in greater detail starting with Chapter "38 Parameter Menu Application". In the main menu there are six icons with the functions described below:



Fig. 37-1 Overview Main Menu

### 37.2 Functions of the first Menu Level

#### 37.2.1 Menu - Application



Fig. 37-2 Menu Application

The application menu includes four submenus.

The measuring point name is entered here and the inputs as well as the digital output are defined:

- Input Types
- Input Ranges
- Units
- And others

Within this menu there is the possibility of diagnosing the inputs and the digital output.  
Possible entries or changes within this menu:

- Damping of signal evaluation/output
- Stability of signal evaluation/output
- Measurement delay and measurement duration

### 37.2.2 Menu - Data

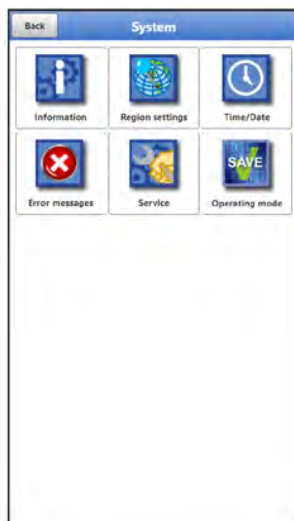


**Fig. 37-3 Menu Data**

The data menu includes all internally saved measurement values.  
The following functions are available:

- Graphic representation of the measurement values
- Communication and transmission options of internal files
- Transfer of set parameters from and to notebook/PC
- Setting and deleting options of the internal data memory

### 37.2.3 Menu - System



**Fig. 37-4 Menu System**

This menu contains information on the data logger:

- Serial Number

- Article Number
- Firmware version
- Information on battery voltage and credits/licences

In addition, the following settings are possible:

- Language
- Units
- Correction of date and time
- Show active error messages
- Delete error memory
- Start device again (Restart) oder shut down (Powerdown)
- Execute parameter reset
- Unlock licenced functions
- Carry out firmware updates
- Configure operation mode and storage cycle

## 37.2.4 Menu - Communication



**Fig. 37-5 Menu Communication**

This menu contains the setting options for communication with other systems as well as for adjustment of user name and password:

- Data Transmission
- Modbus
- HTTP

### 37.2.5 Menu - Battery



**Fig. 37-6 Menu Battery**

The battery voltage present is displayed in the battery menu.

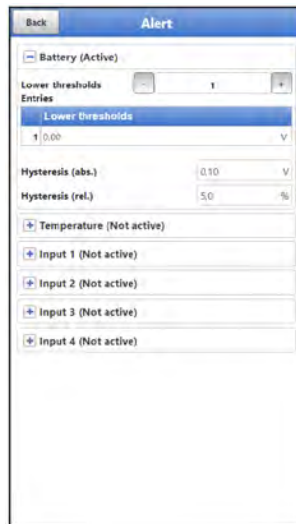


#### **Storage tips for the batteries**

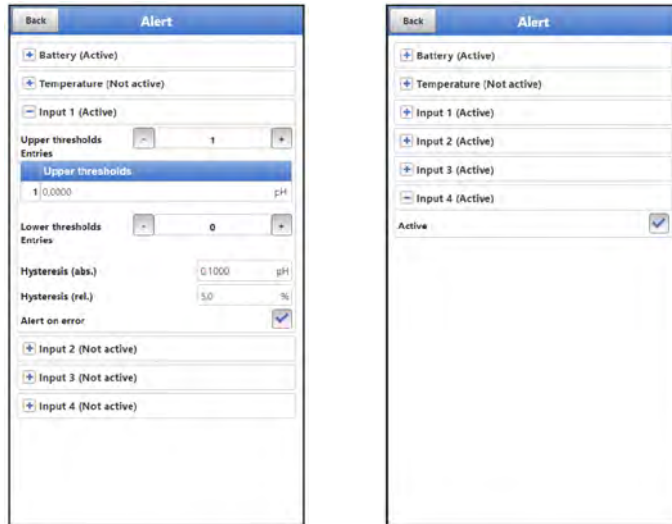
*By basically storing and using the batteries at non-critical temperatures (such as room temperature) and storing them dust-free, clean and dry, their capacity can be maintained for longer.*

*This means that even remote data transmission can often still work well at values in the lower capacity range.*

### 37.2.6 Menu - Alarm







**Fig. 37-7 Menu Alarm**

The Alarm menu consists of up to six sub-items, depending on the parameterisation of the data logger: >Battery<, >Temperature<, >Input 1<, >Input 2<, >Input 3< and >Input 4<. The upper and lower limit values/thresholds and error messages can be set here. When these are reached or occur, the data logger sends an alarm e-mail to the pre-set e-mail address via the NIVUS WebPortal.

## 38 Parameter Menu Application



**Fig. 38-1 Menu Application**

The general parameterisation is described below.

### 38.1 Menu Measurement Place

The name of the measurement place to be parameterised is entered under Measurement Place.

- Open menu >Measurement Place< via "Menu" and >Application<.

When initialising the measurement place name, the default name is automatically deleted after the first letter or number is selected.

- Write the desired measurement place name in the text field and confirm with "Enter". The measurement place name is transferred to the main menu and displayed there.

## 38.2 Menu Inputs

In this menu, the functions of the inputs are defined.

➤ Open menu >Inputs< via "Menu" and >Application<.

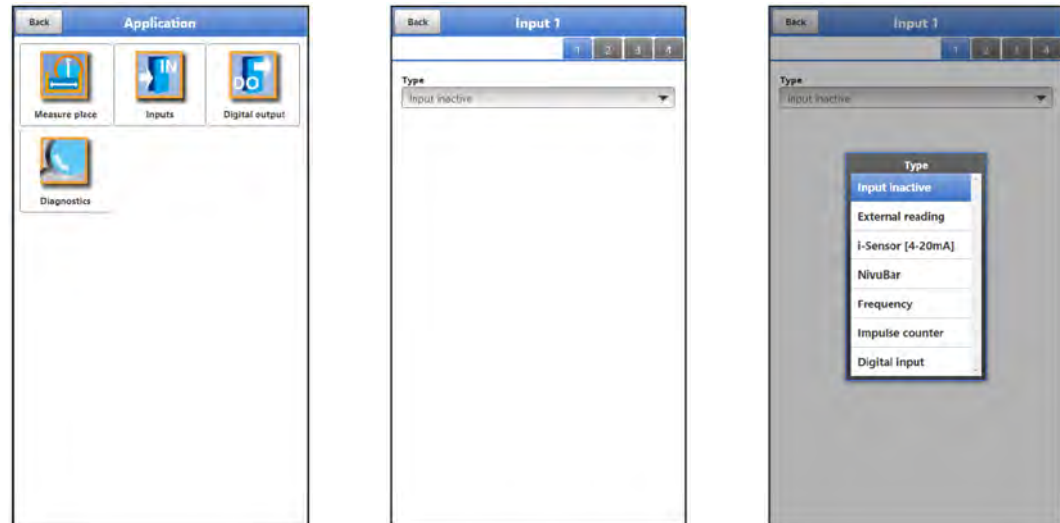


Fig. 38-2 Menu Inputs

The data logger is equipped with four inputs. These are shown in the top right corner of the display and can be selected individually. The selected input is highlighted in colour and the name in the title bar is highlighted with input 1 or 2 or 3 or 4.

The parameters of each input can be set individually. Select the type by using the pop-up menu and then set the parameters.

**Default setting:** Input inactive

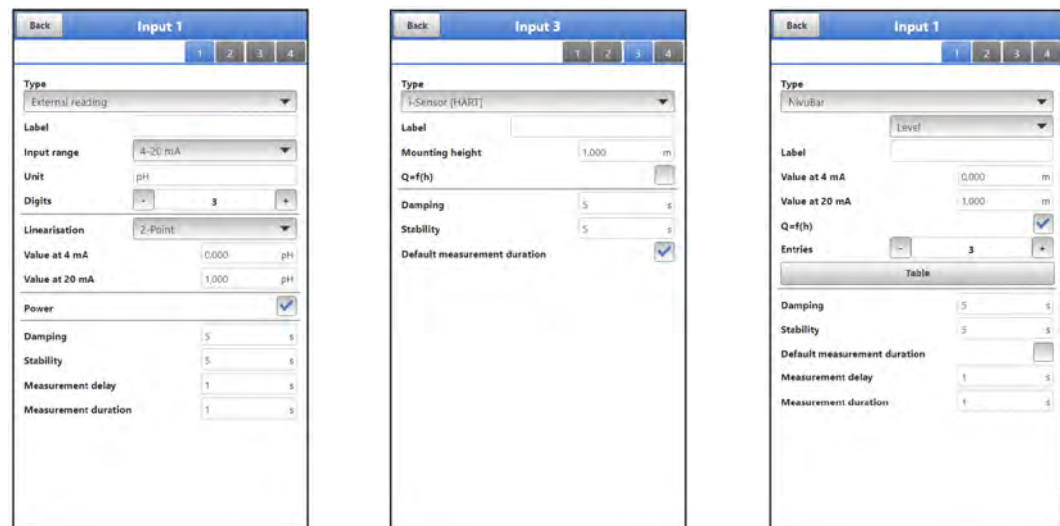


Fig. 38-3 Input as External Measurement Value / i-Sensor (HART) / NivuBar

- **External Measurement Value**
  - Selection/input options:  
Designation: manual input  
Input range: >0-20 mA< oder >4-20 mA< oder >0-10 V<  
Unit: manual input  
Decimal digits: input of the number using the "+" and "-" keys (0...5 possible depending on selected unit)  
Linearisation: >2-Point< or >Table<

- For >2-Point< linearisation: manual input of the values for 4 or 20 mA or 0 or 10 V
- For >Table< linearisation: enter the number of >Entries< via the "+" and "-" keys (max. 32 possible), then select >Table<, fill in and confirm
- Supply: check if required
- Checked: the sensor supply is activated during the measurement cycle
- Unchecked: no further settings required
- Damping: manual entry in seconds
- Stability: manual entry in seconds
- Measurement delay: manual entry in seconds
- Measurement duration: manual entry in seconds

- **i-Sensor (HART) (only for Input 3)**

- Selection/input options:
  - Designation: manual input
  - Mounting height: manual input
  - Q=f(h): check if required
  - Checked: enter the number of >Entries< via the "+" and "-" keys (max. 32 possible), then select >Table<, fill in and confirm
  - Unchecked: no further settings required
  - Damping: manual entry in seconds
  - Stability: manual entry in seconds
  - Standard measurement duration: check if required
  - Checked: no further settings required
  - Unchecked: manual entry of measurement delay and measurement duration in seconds

- **i-Sensor (4-20 mA)**

- Selection/input options:
  - Designation: manual input
  - Value at 4 mA: manual input
  - Value at 20 mA: manual input
  - Q=f(h): check if required
  - Checked: enter the number of >Entries< via the "+" and "-" keys (max. 32 possible), then select >Table<, fill in and confirm
  - Unchecked: no further settings required
  - Damping: manual entry in seconds
  - Stability: manual entry in seconds
  - Standard measurement duration: check if required
  - Checked: no further settings required
  - Unchecked: manual entry of measurement delay and measurement duration in seconds

- **NivuBar**

- Selection/input options:
  - Select the type: >Level< or >Pressure<
  - Designation: manual input
  - Value at 4 mA: manual input
  - Value at 20 mA: manual input
  - Q=f(h) (only for type >Level<): check if required
  - Checked: enter the number of >Entries< via the "+" and "-" keys (max. 32 possible), then select >Table<, fill in and confirm
  - Unchecked: no further settings required
  - Damping: manual entry in seconds
  - Stability: manual entry in seconds
  - Standard measurement duration: check if required
  - Checked: no further settings required
  - Unchecked: manual entry of measurement delay and measurement duration in seconds

- **Frequency (only for Input 1)**
  - Selection/input options:  
Designation: manual input  
Minimum: manual input  
Maximum: manual input  
Unit: manual input  
Decimal digits: input of the number using the "+" and "-" keys (0...5 possible depending on selected unit)  
Linearisation: >2-Point< or >Table<
    - For >2-Point< linearisation: manual input of the values for "Minimum" or "Maximum" (as defined previously)
    - For >Table< linearisation: enter the number of >Entries< via the "+" and "-" keys (max. 32 possible), then select >Table<, fill in and confirmSupply: check if required
    - Checked: the sensor supply is activated during the measurement cycle
    - Unchecked: no further settings requiredPullup: check if required
    - Checked: if a connected unit does not report "0" / "1" but "0" / "nothing", enables pullup internal recognition/discrimination of the input signal
    - Unchecked: no further settings requiredDamping: manual entry in seconds  
Stability: manual entry in seconds  
Standard measurement duration: check if required
    - Checked: no further settings required
    - Unchecked: manual input of measurement delay and measurement duration in seconds
  
- **Impulse Counter (only for Input 1) (e. g. for Rain Gauge RMT0)**
  - Selection/input options:  
Designation: manual input  
Unit: manual input  
Decimal digits: input of the number using the "+" and "-" keys (0...5 possible depending on selected unit)  
Increment: manual input  
Absolute counter: check if required (for Rain Gauge RMT0 uncheck)
    - Checked: the determined values are specified relatively
    - Unchecked: the determined values are specified absolutelyEdge: >falling< or >rising<  
Filter: manual input in milliseconds  
Supply: check if required
    - Checked: the sensor supply is activated during the measurement cycle
    - Unchecked: no further settings requiredPullup: check if required  
(uncheck if the jumper (short circuit bridge) is plugged to reduce power consumption)
    - Checked: if a connected unit does not report "0" / "1" but "0" / "nothing", enables pullup internal recognition/discrimination of the input signal
    - Unchecked: no further settings required
  
- **Digital Input**
  - Selection/input options:  
Designation: manual input  
Logic: >not inverted< or >inverted<  
Filter: manual input in milliseconds  
Supply: check if required
    - Checked: the sensor supply is activated during the measurement cycle
    - Unchecked: no further settings requiredPullup: check if required
    - Checked: if a connected unit does not report "0" / "1" but "0" / "nothing",

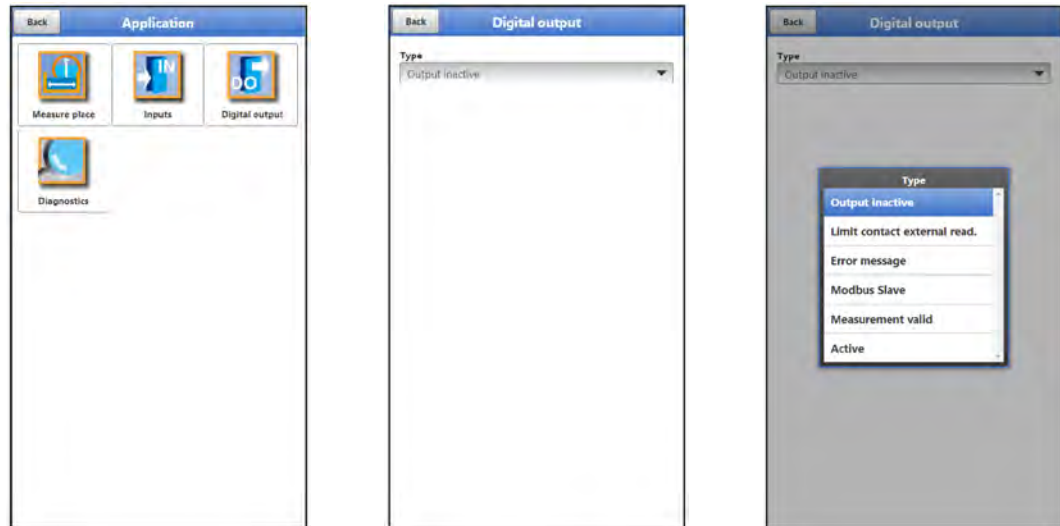
enables pullup internal recognition/discrimination of the input signal  
 - Unchecked: no further settings required

## 38.3 Menu Digital Output

The data logger is equipped with one digital output.

**Default setting:** Output inactive

The following different functions can be assigned to the digital output.



**Fig. 38-4 Menu Digital Output**

- **Limit Contact external Reading**  
 A digital signal is output when the entered high external reading limit value is exceeded. If the flow falls below the low external reading limit value, this digital signal is reset = hysteresis function to prevent fluttering outputs.
  - Selection/input options:  
 Logic: >Normally open< or >Normally closed<  
 Analogue input: >Input 1< or >Input 2< or >Input 3 or >Input 4<  
 Threshold On: manual input  
 Threshold Off: manual input  
 Amount: check if required (no further settings required)  
 Value at error: >On< or >Off< or >Hold Value<  
 Delay: manual input  
 Hold: manual input
- **Error Message**  
 By activating the individual selection fields (check box) using the push button, the individual error types to be output can be assigned to the digital output. Furthermore, the output logic can be changed between normally closed and normally open function.
  - Selection/input options:  
 Logic: >Normally open< or >Normally closed<  
 Error mask:  
 - External reading: check if required (no further settings required)  
 - System: check if required (no further settings required)
- **Modbus Slave**  
 The digital input can be controlled by an external Modbus master.
  - Selection/input options:  
 Logic: >Normally open< or >Normally closed<

- **Measurement invalid**  
If the NLG02 takes measurements as a Modbus slave for a Modbus master, it goes back to sleep mode after the measurement. In this condition, the Modbus master cannot address it. With the help of this function, the digital output of the NLG02 is used to signal the Modbus master: "The measurement is finished". For the duration of the defined hold time, the NLG02 then remains awake so that the Modbus master can contact it if necessary.
  - Selection/input options:  
Logic: >Normally open< or >Normally closed<  
Hold: manual input
- **Active**  
As soon as the data logger "wakes up" from sleep mode, the digital output is switched; when switching to sleep mode, the digital output is also switched off again. With this switching on/off, the signal is sent to the external system/sensor that the measurement can/should now take place.
  - Selection/input options:  
Logic: >Normally open< or >Normally closed<

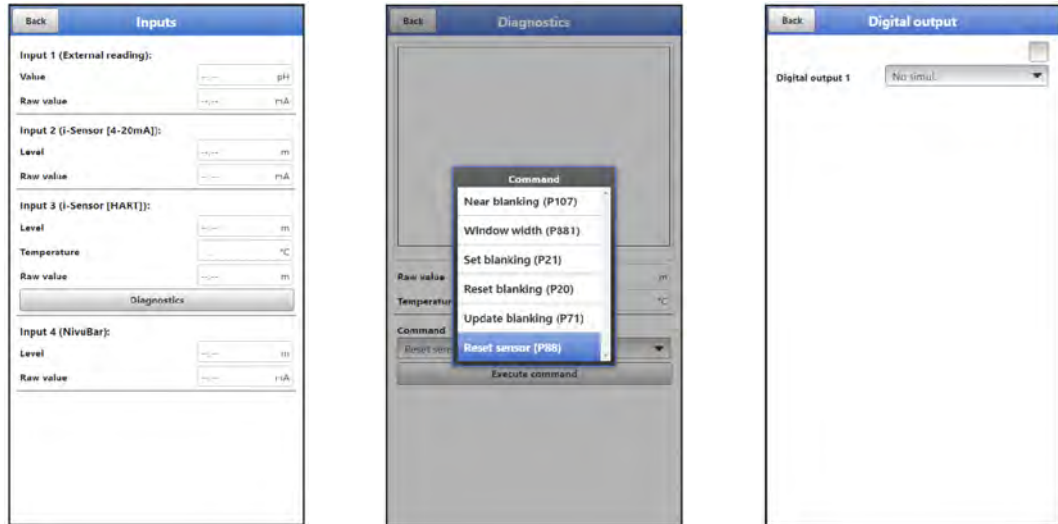
### 38.4 Menu Diagnostics



**Fig. 38-5 Menu Diagnostics**

The menu >Diagnostics< can be found in the >Application< menu.

In the Diagnostics menu and the two submenus, current settings of the inputs and the digital input can be displayed.



**Fig. 38-6 Diagnostics inputs / digital output**

Depending on the previous parameterisation under >Application< / >Inputs<, different data and values are displayed.

Shown for the >Inputs<:

- **>External Reading<:**  
Value: output calculated value  
Raw value: value actually measured
- **>i-Sensor (HART)<:**  
Level: output calculated level  
Temperature: actual medium temperature  
Raw value: actual measured value  
In addition, various commands can be sent to the i-Sensor here (see Fig. 38-6 centre figure): "Near Blanking (P107)", "Window Width (P881)", "Set Blanking (P21)", "Reset Blanking (P20)", "Update Blanking (P71)" and "Reset Sensor (P88)".



### **Expert knowledge required**

*These settings require extensive expert knowledge and require the use of NIVUS commissioning personnel or an authorised specialist company.*



Observe also the instruction manual for i-Series sensors and HART PC software.

- **>i-Sensor (4-20mA)<:**  
Level: output calculated level  
Raw value: value actually measured
- **>NivuBar<:**  
Level: output calculated level  
Raw value: value actually measured
- **>Frequency<:**  
Value: output calculated value  
Raw value: value actually measured

- **>Impulse Counter<:**  
Value: output calculated value  
Raw value: value actually measured
- **>Digital Input<:**  
Check for value if required: output calculated value  
Check for raw value if required: value actually measured

For **>Digital Output<**,

- the actual parameter status is displayed per default setting:
  - Checked: digital input active
  - Unchecked: digital input not active
- a simulation of the digital output is activated by:
  - **>Simulation On<**: box is checked and thus an active digital input is simulated (independent of the actual parameterisation)
  - **>Simulation Off<**: box is not checked and thus an inactive digital input is simulated (independent of the actual parameterisation).
  - **>No Simul.<**: ends the simulation and displays the actual parameterisation situation again

### 39 Parameter Menu Data

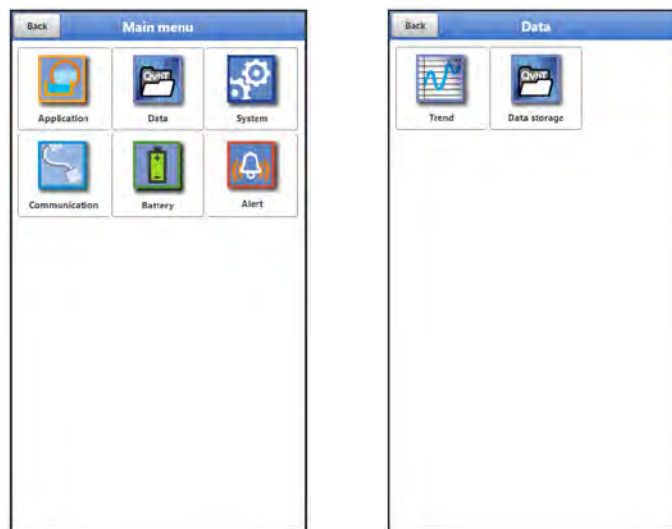
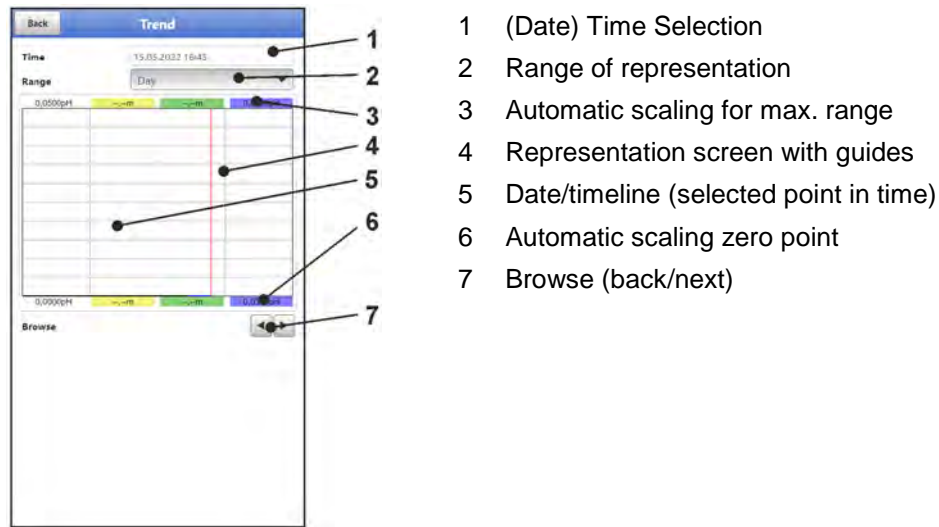


Fig. 39-1 Menu – Data



## 39.1 Menu Trend

The trend display is a visualising recorder function. When the trend display is selected, current and previously stored (historical) measurement data can be accessed.



**Fig. 39-2 Representation Trend Graph**

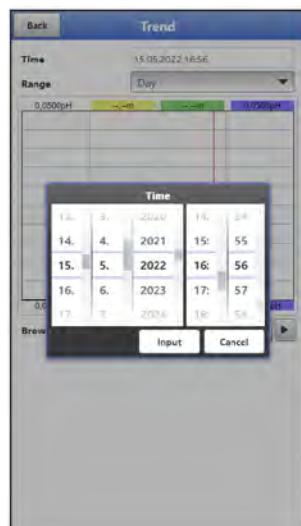
### Current Measurement Data

➡ Procedure for the representation of current readings:

1. Select the desired range (range of representation; Fig. 39-2 Pos. 2). The selected range is displayed.
2. If necessary, use the arrows (Fig. 39-2 Pos. 7) to scroll forwards and backwards with the same basic display setting.
3. Back to the main screen via "Back" (3x).

### >Time<

When the Trend menu is opened, the current date and time are displayed. If historical measurement data or a specific point in time is to be displayed, this can be set via the date/time selection (Fig. 39-2 Pos. 1). The selection mask shown below opens here (Fig. 39-3). If a start date is selected, (depending on the range set) the measurement data is shown in the display area below.



**Fig. 39-3 Selecting Date/Time**

**>Range (Period of representation)<**

The selection of the range determines which period is to be displayed in the display area.

Selection	Representation in the Display Area		
	Left Margin	Right Margin	Guides
Hour	0 Minutes	59 Minutes	15 Minutes each
4 Hours	0/4/8/12/16/20 o'clock, depending on the set time	4 Hours later	1 Hour each
Day	0 o'clock	24 o'clock	6 Hours each
Week	Monday, 0 o'clock	Sunday, 24 o'clock	1 Day each
4 Weeks	Monday, 0 o'clock	4 Weeks later, Sunday, 24 o'clock	1 Week each, time reference point for the start: 01.01.1970, 0 o'clock

**Tab. 8 Explanation of the periods displayed**

Below the display you can find the **>Browse<** function.

- ➡ Browse forwards or backwards using the arrow symbols: by one selected period unit (Hour, 4 Hours, Day, Week or 4 Weeks) each time the button is pressed.

## 39.2 Menu Data Memory



**Fig. 39-4 Menu Data Memory**

The data logger has an internal data memory (max. 182,398 measuring cycles, after which it is overwritten). The data and parameters stored in it can be transferred partially or completely to a file or to a USB stick.

The parameters can be (re)transmitted back to the data logger, but the (measurement) data cannot.



***Use of the USB interface is only permitted outside the Ex area.***

## Procedure:

1. Open the enclosure flap according to Chap. "22 Open / Close the Data Logger Enclosure".
2. Insert the corresponding USB cable into the Micro-USB interface.
3. Connect the NLG02 to the notebook/PC via USB cable.
4. Transmit data with >Load Parameters< or >Save Parameters<.
5. Disconnect the USB cable and close the enclosure flap.



Fig. 39-5 Set start/end time

- **>from< / >to<**  
Sets the start and end time of the period from which the data to be transmitted originates. The selection is made in a kind of calendar (Fig. 39-5).  
Per default, the data logger offers the transmission period since the last data transmission up to the current time.
- **>File Format<**  
>csv< or >txt<
- **>Data Depth<**  
The data depth is divided into three areas. The respective contents are highly dependent on the measurement place and are therefore not listed in detail here.
  - **>Standard<**  
This memory format is sufficient for most applications and corresponds with the default setting.
  - **>Extended<**  
The stored data records contain extended information.
  - **>Expert<**  
In this software version, the data depth >Expert< is identical to the data depth >Extended<. As part of the usual further development of the devices, subsequent software versions may well contain other functions and data.  
Such data sets should only be activated by specially trained service personnel or developers of the NIVUS GmbH. These data sets can quickly become very large. If necessary contact NIVUS.
- **>Download<**  
With this function, the measured values of the predefined period can be saved to a file on the operating device (notebook, PC etc.). The storage format is either "csv" or "txt" depending on the previous selection.

- **>Delete Memory<**

The complete data of the internal data memory can be deleted here. After selecting, you will be asked whether you want to delete. After confirming with >Yes< the data is deleted, with >No< the process is cancelled.



**Important Note**

*Deleted data cannot be restored!*

- **>Load Parameters<**

With this function a previously saved parameter file can be loaded from notebook/PC to the data logger.

- **>Save Parameters<**

Here the set parameterisation of the measurement place can be loaded to the notebook or PC. Here two files are created and saved.

The files have the following formats:

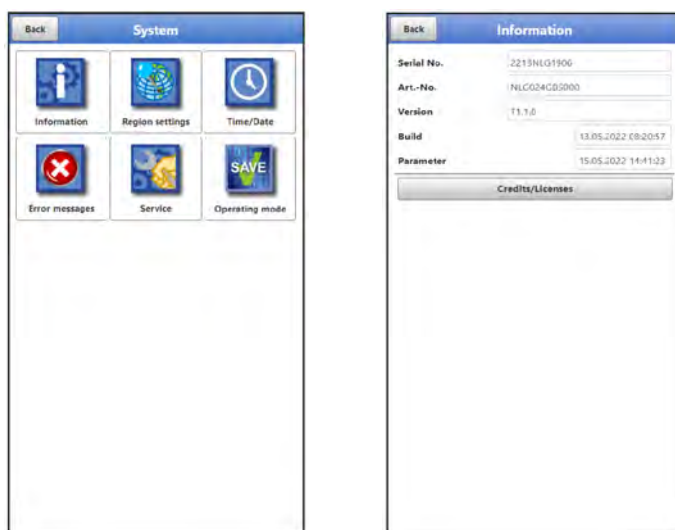
- **XXXX\_DOC\_AABBCCDDEE.pdf**  
This file is for documentation purposes and contains basic settings and parameter changes made.
- **XXXX\_PAR\_AABBCCDDEE.xmz**  
This file contains the complete parameter set of the data logger. It is used to save the parameterisation that has been set and can be reloaded in this format by using >Load Parameters<.

**Information on File Naming:**

XXXX = Programmed name of the measurement place  
 AO = Year  
 BB = Month  
 CC = Day  
 DD = Hour  
 EE = Minute

## 40 Parameter Menu System

### 40.1 Menu Information



**Fig. 40-1 Menu - System - Information**

The menu >Information< is a display menu. It contains the following information on the device:

- Serial number and article number
- Firmware version of the data logger
- Date of the last software update (firmware) and the last parameter storage
- Information on credits and licences

## 40.2 Menu Country Settings

In this menu you can make the following settings:

- (Operating) Language
- Date Format
- Units of the measurement values  
Here it is possible to distinguish between displayed and stored measured values.

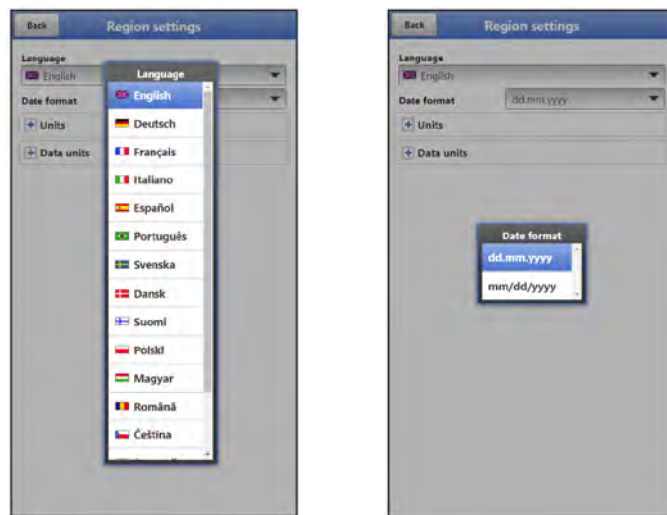


Fig. 40-2 Country Setting - Language - Date Format

### 40.2.1 (Operating) Language

All listed languages (Fig. 40-2) provide texts in the national language or the substitute language English.

### 40.2.2 Date Format

The following date formats can be set:

- DD.MM.YYYY (Day/Month/Year)
- MM/DD/YYYY (Month/Day/Year)

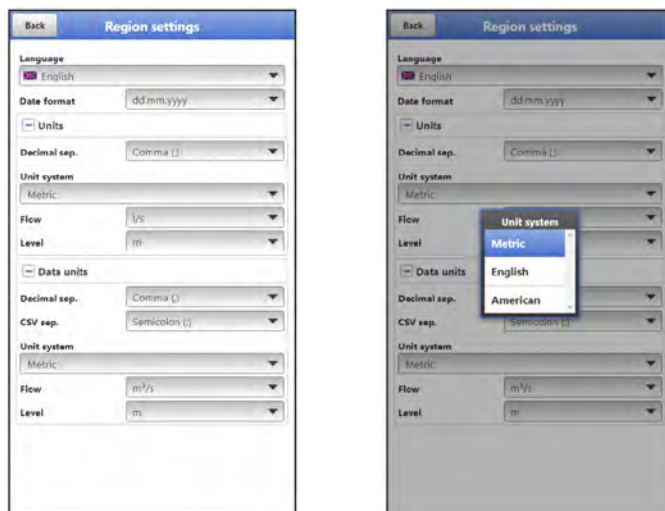
### 40.2.3 Units

At this point, various country-specific and unit system-dependent settings for the measurement values can be set.

>Decimal Separator<

- Dot
- Comma

The decimal separators entered here are only used for the display of the notebook/PC.



**Fig. 40-3 Units system**

### >Units System<

The choices are:

- Metric
- English
- American

The **adjustable units** depend on the previous selection of the unit system:

- In metric systems: mm, cm, l/min, m<sup>3</sup>/h etc.
- In the English system: ft<sup>3</sup>/s, Mgal/d, gal/s, in, yd, °C, °F etc.
- In the American system: gps, cfd, in, ft etc.

### Units for the representation in the display for

- Flow
- Level
- Temperature (only in unit system "English")

## 40.2.4 Data Units

The settings >Data Units< are analogous to the settings of the >Units<.

In >Data Units< the recorded measurement values are **converted and stored** according to the selected unit.

### >Decimal Separator<

- Dot
- Comma

The specification of the decimal separators is important for the correct reading of the data. This is especially important when evaluating the measurement data with a software in a different language (e.g. English Excel), that the decimal separators are correctly selected.

### >CSV Separator<

- Comma (,)
- Semicolon (;)

This selection determines how the individual data are separated in the .csv file when reading out the data.

## >Units System<

The choices are:

- Metric
- English
- American

## Units for the Storage

- In the metric system: l/s, m<sup>3</sup>/s, m<sup>3</sup>/d, cm/s etc.
- In the English system: ft<sup>3</sup>/s, in, gal/min, Mgal/d, in/s, yd/s etc.
- In the American system: gps, gpm, cfs, cfm, cfh, cfd, mgd etc.

## Units for the Storage of Measurement Data for

- Flow
- Level
- Temperature (only in unit system "English")

### 40.3 Menu Time/Date

In this submenu, the current date and the system time of the data logger can be changed manually. The system time is based on the coordinated universal time UTC (en.: "Universal Time Coordinated"). The time zones are defined by "plus" or "minus" hours compared to UTC.

**NIVUS** strongly **recommends** keeping the system time of the data logger and defining the respective time zone and also summer/winter times by the >Time Zone (UTC)<.

With >**Change System Time**< the manually changed system time and the time zone are applied.

Via >**Synchronise System Time**< the system time and time zone are automatically synchronised with the connected computer.

Using the >Time/Date< menu may be necessary for the time changeover from summer time to winter time, after a battery-free period of approx. 6 hours (max. buffer time of the internal buffer capacitor) or after a power failure.

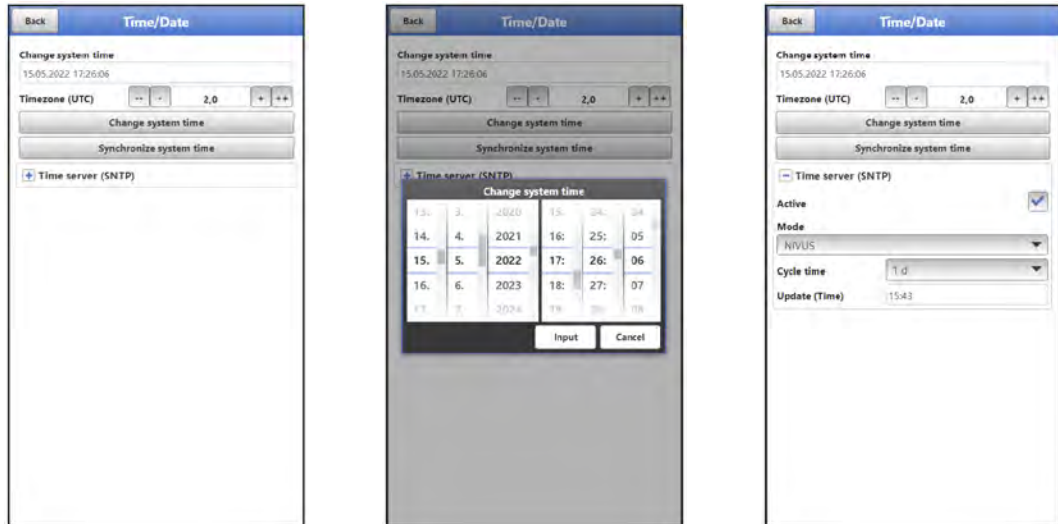
If the data logger is operated for a longer period of time, the internal clock may deviate. These deviations can be corrected here.



#### **Effects of a System Time Change**

*Changing the system time affects the storage of the data. If data storage is activated, duplicate data or data gaps may occur after system time changes.*

---



**Fig. 40-4 Change system time: automatically and manually**

The current system time is set via the selection menu (Fig. 40-4).

The time deviation (UTC or GMT) from the prime meridian is done via the "+" and "-" fields:

- = Decrease by 1 hour each
- = Decrease by ½ hour each
- + = Increase by ½ hour each
- ++ = Increase by 1 hour each

If **>Time Server (SNTP)<** is activated, the data logger is automatically synchronised with a time server. The SNTP protocol is used for this.

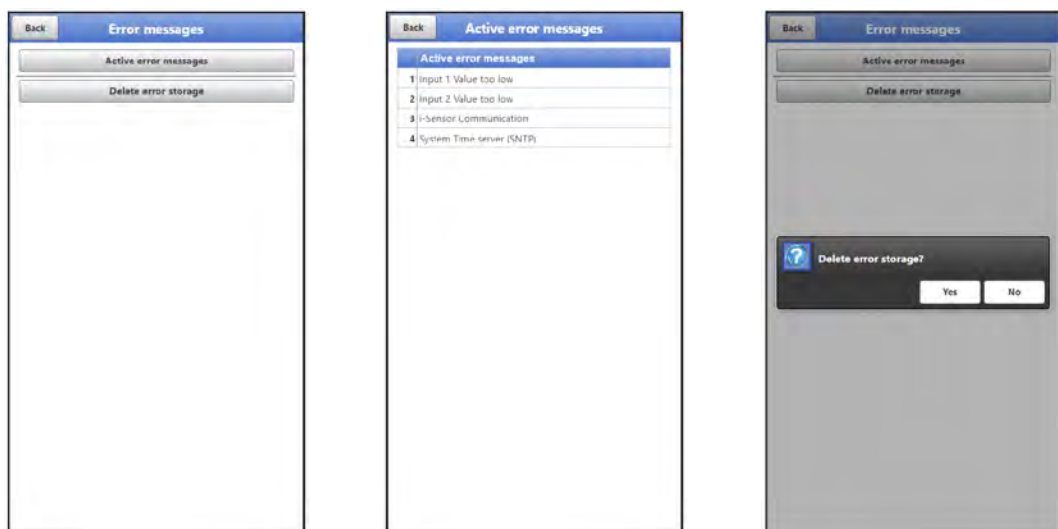
For this purpose, the **>Mode<** is selected here (NIVUS or User defined), the **>Cycle Time<** is defined (1 d, 2 d, 3 d, 4 d or 7 d) and the time for the respective **>Update (Time)<**.

In **>Mode<** "User defined", the server path must also be entered.

## 40.4 Menu Error Messages

In this menu, the current pending error messages can be called up and the error memory can be erased.

The data is password protected to prevent accidental deletion.



**Fig. 40-5 Error messages**



## 40.5 Menu Service

This submenu contains the following functions:

- Service levels (secured with passwords); the service levels are exclusively reserved for the NIVUS service
- Restart (of system)
- Powerdown (switching off the data logger to energy-saving mode)
- Parameter reset (back to default settings)
- Feature Unlock
- Update NivuLink Micro II



**Fig. 40-6 Service NivuLink Micro II**

### 40.5.1 Service Level

The service levels are divided into different access levels and protected accordingly with passwords.

The settings possible there and the information stored require extensive specialist knowledge and are not required for the usual applications. Therefore, they are reserved exclusively for NIVUS service personnel.

### 40.5.2 Restart

A restart of the data logger interrupts the current measurement process.

The system boots using the set (saved) parameters. After booting, the system behaves as when it is switched on (analogous to the PC).

This menu point replaces switching the system off and on again. All saved parameters, counters and stored data are retained.

### 40.5.3 Powerdown

The >Powerdown< function switches the data logger into a energy-saving mode. The unit will not resume its measuring function until it is "woken up".

### 40.5.4 Parameter Reset

During parameter reset, all parameters are reset to the default settings. Counter readings, changed passwords and stored measurement data are retained in the system.

The actual resetting of the parameters is only carried out after exiting the service menu (back to the main menu) and confirming the storage. The process can still be cancelled at this point.

### 40.5.5 Feature Unlock

Special (optionally available) functions can be enabled via the feature unlock, provided these have been ordered from NIVUS.

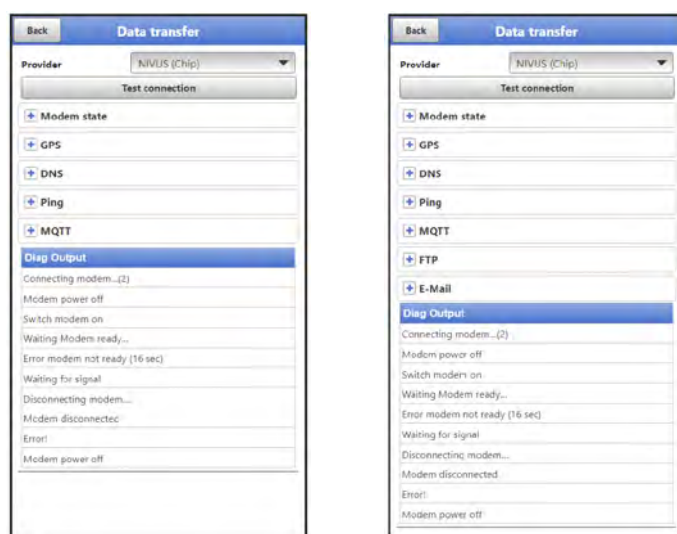
*Info:*

*The following is an example of the procedure for activating the licence "FTP/SMTP Client" (NFM LIZENZ FTP). The procedure for all other optionally available functions is similar.*

#### Function Description "FTP/SMTP Client"

The remote data transmission can be transmitted via different channels. Basically possible:

- Via MQTT to the NIVUS WebPortal or to a customer system via NIVUS DataKiosk
- Via FTP to the NIVUS D2W data portal to a customer FTP server
- Via e-mail to a pre-defined address



**Fig. 40-7 Menu Communication: without licences / with licences**

All NivuLink Micro II data loggers are delivered in the basic version with the version for "MQTT Data Transmission". This variant is automatically activated and available immediately after the initial commissioning and corresponding activation of MQTT.

Data transfer via FTP and e-mail is additionally available via a combined licence and can either be ordered when placing the order or subsequently at any time.

The link to the NIVUS WebPortal (for the activation of this licence) will be sent by e-mail to the customer or the responsible country representative \*<sup>1</sup>) after dispatch of the ordered device or following the subsequent licence order. Manual activation is carried out by the user \*<sup>1</sup>) (see Chap. "Activation of the Licence"). As soon as the NivuLink Micro II is parameterised accordingly, the data transmission variant can be selected and the data transmission started.



Parameter settings see Chap. "41 Parameter Menu Communication" (for the described example).

**One licence** is only valid for exactly **one device** and is permanently assigned to it through the **serial number**.

\*<sup>1</sup>) *Depending on the recipient country, the licence is activated by the responsible country representative even before the unit is shipped to the customer; all ordered features are then immediately available to the customer.*

## Activation of the Licence

➡ Procedure for **ordering a device with a licence** using the example of "FTP/e-mail data transfer":

1. Place order for NivuLink Micro II device with the respective licence(s) for remote data transmission.  
Internally at NIVUS, processes are started which, on the one hand, concern the production of the NLG02 device and, on the other hand, initiate the licensing process.
2. After receiving the NLG02 device, log in to the NIVUS WebPortal and open the "Licences" tab. The access data was sent in advance by NIVUS via e-mail to an agreed e-mail address.

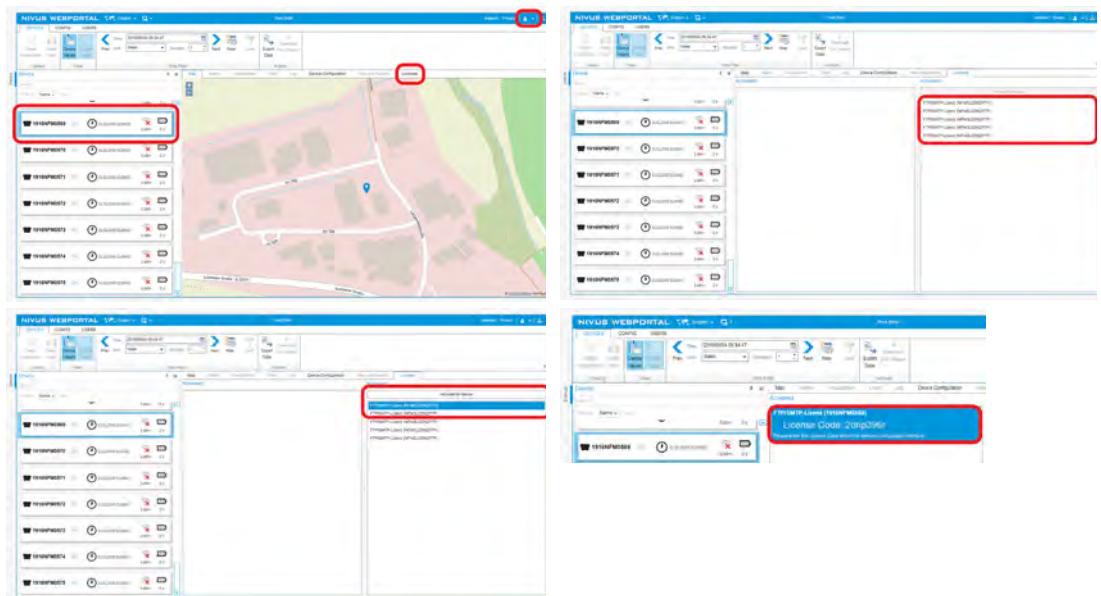


### **Assignment of the licence to the device unchangeable after being carried out**

*One licence is only valid for exactly one device and is permanently assigned to it through the serial number. This assignment **cannot be changed** or **cannot be undone**.*

*Before assigning, check exactly which device must/should be linked to which licence so that the correct device also receives the licence and can use this feature.*

3. The existing NLG02 device(s) is/are listed in the NIVUS WebPortal. The ordered licences are displayed in the right-hand display field. These licences must be linked to the units via the serial numbers.  
To do this, select the corresponding licence and click on "Activate". The selected licence disappears from the right-hand display field, but the associated licence number with the activation code is displayed on the unit. This activation code is subsequently required (once) for the parameterisation of the individual devices.
4. Proceed in the same way with other licences.
5. Log out from the NIVUS WebPortal and exit the application.



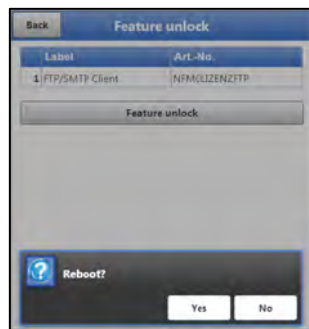
**Fig. 40-8 Activation and licence in the WebPortal (principle)**

6. Open the respective NLG02 via notebook, PC and select >Feature Unlock< (Fig. 40-9) in the >System< / >Service< menu.
7. Click the >Feature Unlock< button.
8. Enter the corresponding activation code and confirm with Enter. The linked licence is shown in the display.



**Fig. 40-9 Activation of the licence in the NLG02 display tool**

9. The NLG02 confirms the activation and with "Back" requests a device restart. In the menu >Communication< / >Data Transmission<, the data transfer via FTP / e-mail option is now available.



**Fig. 40-10 System restart after feature unlock**

10. Select/enter and save parameters in the >Communication< menu.

➡ Procedure for **later ordering the licence** "FTP/E-Mail Data Transmission":

1. Place order for the desired licence(s) for data transmission. Internally at NIVUS, processes are started which initiate the licensing process.
2. After receiving the access data, log in to the NIVUS WebPortal and open the "Licences" tab. The access data was sent by NIVUS via e-mail to an agreed e-mail address.
3. Proceed with step 3 from the description "Procedure for ordering a device with a licence using the example of the "FTP/E-Mail Data Transmission"". Please also note the important information on "Assignment of the licence to the device" on page 75.

#### 40.5.6 Update NivuLink Micro II

Upload of a NivuLink Micro II firmware saved on a drive of the connected notebook/PC.



**Important Note**

*Update only in consultation with NIVUS GmbH or the responsible local (country) representation.*

## 40.6 Menu Operating Mode

In the >Operating Mode< menu, the types of >Operating Mode<, the >Storage Cycle< and the >Measurement Duration< are set. Depending on the selected operating mode, the further settings described below are possible.

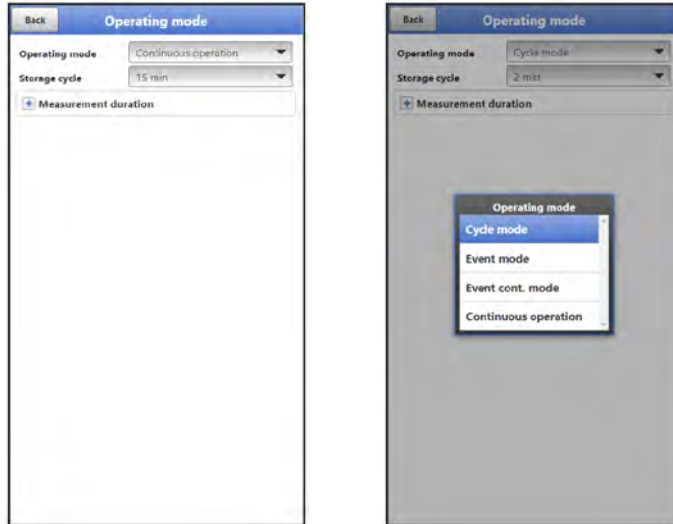


Fig. 40-11 Storage Mode – Operating Mode

### Operating mode, storage cycle, event interval and measurement duration

The selected operating mode determines when and how often the data logger should take measurements and also save them. Depending on the operating mode, the storage cycle and the event interval can be set.

The choices for >Operating Mode< are:

- **>Cycle Mode<**  
The data logger wakes up at the intervals of the set storage cycle, measures for a short time and stores the determined measurement values. After that, the data logger goes back to sleep mode until the next measurement.
- **>Event Mode<**  
The event mode is an extended cycle mode. It has the same parameters and functionality as the cycle mode. In addition, it is possible to switch to the >event interval< by detecting the exceeding or falling below of a definable measured variable of inputs 1 to 4.  
**>Input 1<** to **>Input 4<** can be activated individually (check) and the respective switching threshold (manual entry) and the mode (> or <; event starts when the entered value is exceeded or not reached) can be set.
  - If **one** of the inputs is activated, the **>Cycle<** must also be selected: "Storage Cycle" or "Event Interval" are available.  
This >Cycle< defines the (previously set) time interval at which the data logger should search for events.  
If **at least two** inputs are activated, the **>Logic<** must also be selected: Possible are "Or" or "And".

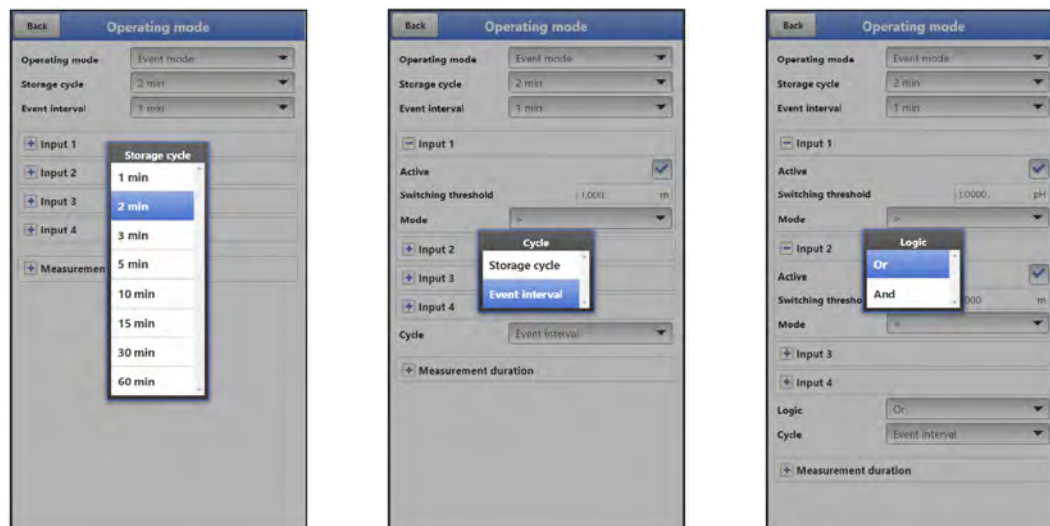


Fig. 40-12 Storage cycle (time interval), cycle and logic

- >Event Continuous Mode<**  
 The event continuous mode and its parameter settings are largely identical to the event mode (for details on settings see the previous section).  
 In contrast, the data logger does not switch off cyclically in the event interval during the event to save energy, but measures in continuous operation. The data is damped continuously and stored in the cycle of the event interval.  
 The event continuous mode thus consumes slightly more energy than the event mode, but leads to more consistent measurement results for events with strongly fluctuating measured values (e.g. due to waves).
- >Continuous Operation<**  
 The data logger measures continuously, but stores the measured values only at the intervals of the set storage cycle. The permanently determined individual measured values are damped internally here. The average value of the measured values is saved. Continuous operation requires energy throughout and is not recommended due to the power supply of the device by batteries.

**>Storage Cycle<**

Selection: 1 min, 2 min, 3 min, 4 min, 5 min, 6 min, 10 min, 12 min, 15 min, 20 min, 30 min, 60 min, 2 h, 3 h, 4 h, 6 h, 8 h, 12 h and 24 h

**>Event Interval<**

Setting options: 1 min, 2 min, 3 min, 5 min, 10 min, 15 min, 30 min and 60 min

**>Measurement Duration<**

Setting of the minimum and maximum measuring duration in seconds.

Minimum: 0 s – 900 s (default setting: 1 s)

Maximum: 1 s – 900 s (default setting: 60 s)

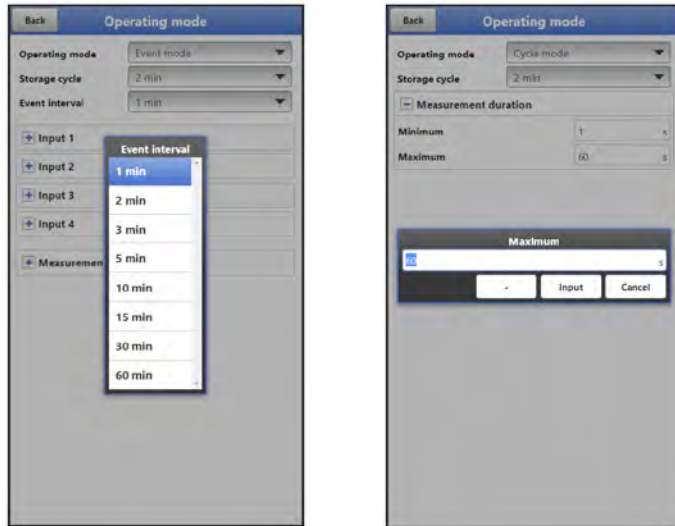


Fig. 40-13 Event interval (time interval) and measurement duration

## 41 Parameter Menu Communication

In the menu >Communication< the parameters for data transmission and for Modbus communication are displayed or set and the user name and password are managed under HTTP. Communication is done with the notebook/PC or other devices.



Fig. 41-1 Menu - Communication



## 41.1 Menu Data Transmission

### 41.1.1 Provider

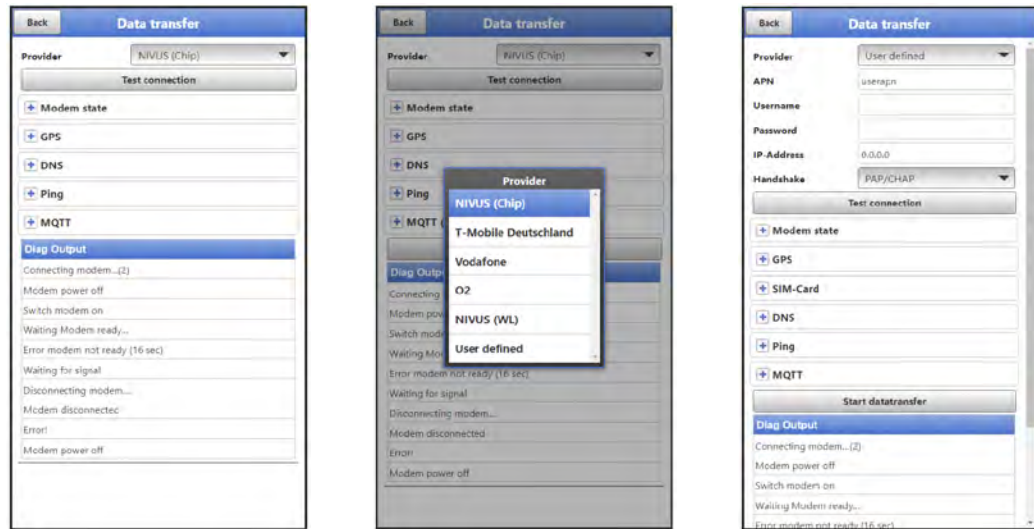


Fig. 41-2 Provider

Depending on the **provider**, individual data must be entered here or is displayed. Data to be entered can be requested from the provider.

Preset data are already stored in the data logger for: "NIVUS (Chip)", "T-Mobile Germany", "Vodafone", "O2" and "NIVUS (WL)".

For "User Defined", missing data must be entered.

After specifying the provider, a **test connection** can be established for test purposes. During the process, a current status info appears in the "Diagnostics Output".

### 41.1.2 Modem State

Display of the current status of the built-in modem.

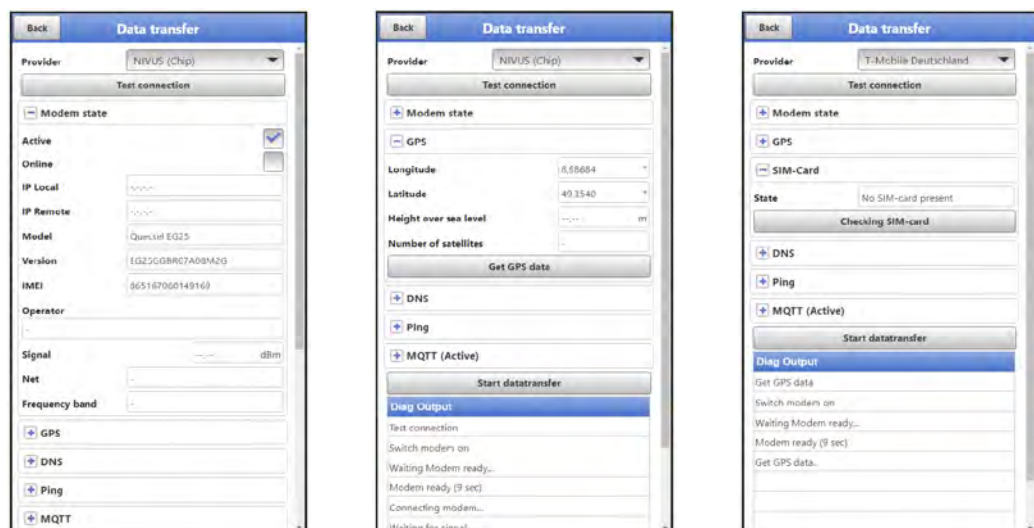


Fig. 41-3 Modem State / GPS / SIM Card State



## 41.1.3 GPS

Display of or search for GPS coordinates at the installation site (see also Fig. 41-3).



### GPS Coordinates Search

*The unit must be positioned so that it has a "clear view" up to the sky when searching for the GPS coordinates. So it is best to do this before placing it in the shaft or a room.*

## 41.1.4 SIM Card

With almost all providers (except NIVUS (Chip)), a customer's own SIM card (see also Fig. 41-3) is required to use the modem. To do this, enter the relevant information and, if necessary, activate the PIN check or carry out a SIM card check.

## 41.1.5 DNS

Addresses of the name servers for address resolution; split into primary and secondary; except if >DNS automatic< is activated, then only primary.

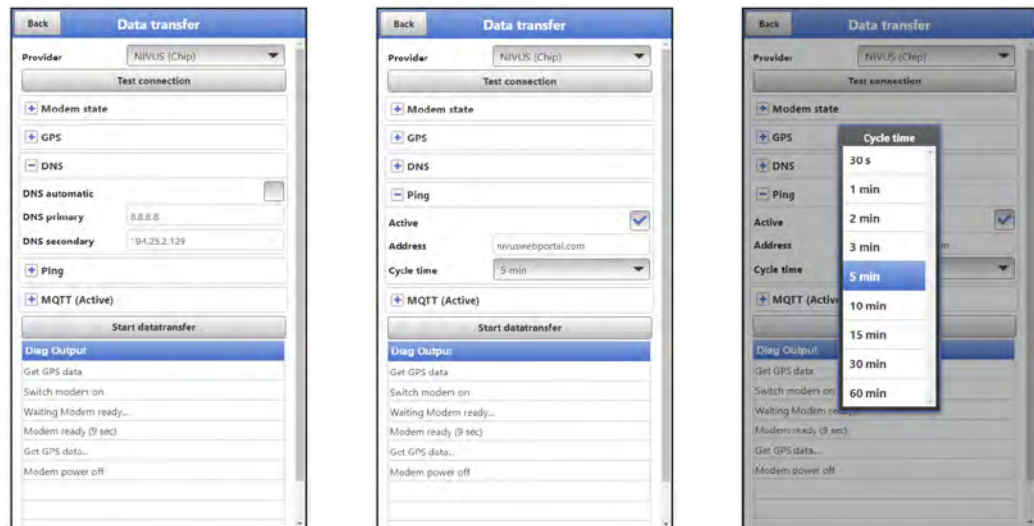


Fig. 41-4 DNS / Ping

## 41.1.6 Ping

Activate self-test of the modem. Here, a certain address can be entered. The self-test can be repeated in certain cycles.

Possible cycle times are: 30 s, 1 min, 2 min, 3 min, 5 min, 10 min, 15 min, 30 min and 60 min.

## 41.1.7 MQTT

Using the MQTT network protocol, all data that accumulates in the data memory is sent to a MQTT server.

- **>Active<:**  
Check the box to activate.
- **>Mode<:**
  - **>NIVUS<:** All attributes and addresses for sending the data are stored in the system.
  - **>User Defined<:** Enter all required attributes and addresses.
    - >Broker<:** The Internet address of the server is entered either as a host name or IP address.
    - >Port<:** Associated port

**>Encryption<:** Activation of secure (SSL/TLS) communication between client and server and use of the port.

- **>Time<:**  
Time of the first daily transmission (factory setting is 00:00).
- **>Cycle Time<:**  
Within one day, several transmissions can take place according to a frequency to be defined. Available are: 15 min, 30 min, 1 h, 2 h, 3 h, 4 h, 6 h, 8 h, 12 h and 24 h.
- **>Event Operation<:**  
Check this box if the transmission is to take place when an event occurs, as an alternative to the specified cycle time.
  - **>Cycle Time Event<:** Possible times to define the frequency: 15 min, 30 min, 1 h, 2 h, 3 h, 4 h, 6 h, 8 h, 12 h and 24 h
- **>Test Settings<:**  
Establish a test connection to the server with the specified values.
- **>Start Data Transfer<:**  
"Manual" data transmission since the last transmitted time stamp (see also Chap. "41.1.10 Preparing the device for data transmission ").



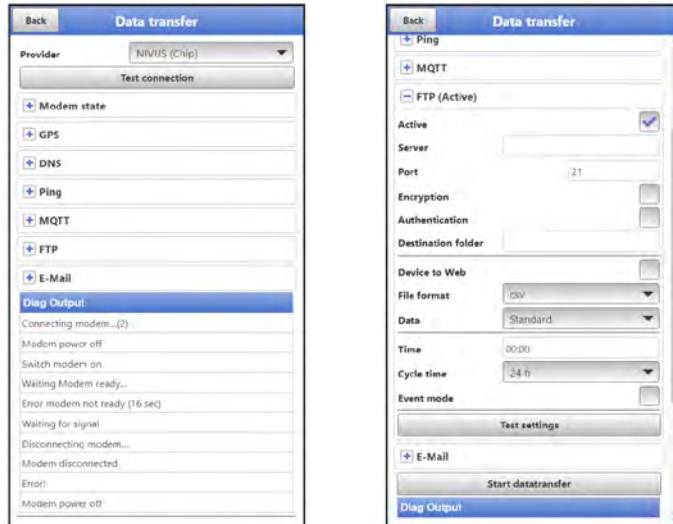
Fig. 41-5 MQTT active / cycle time / event operation

### 41.1.8 FTP (only with licence)

Transmission to a customer FTP server or to the D2W data portal.

Available as an additional function licence (see Chap. "19.2 Add-On Function Licences" and "40.5.5 Feature Unlock").

Option is available only when MQTT is inactive.



**Fig. 41-6 FTP active**

- **>Active<:**  
Check the box to activate.
- **>Server<:**  
Specify server name or IP address.
- **>Port<:**  
Associated port
- **>Encryption<:**  
Activation of secure (SSL/TLS) communication between client and server and use of the port.
- **>Authentication<:**  
Activate with user and password-protected FTP access and specify in user name and password.
- **>Destination Folder<:**  
Enter the destination folder where the files are to be stored.
- **>Device to Web<:**  
Activate when transmitting to the D2W; the Device-to-Web compatible format is applied.
- **>File Format<:**  
There are csv and txt available.
- **>Data<:**  
Determination of the data depth to be transmitted (see also Chap. "39.2 Menu Data Memory").
  - **>Standard<:**  
Basic data
  - **>Extended<:**  
Extended data package (available only via additional licences; see Chap. "19.2 Add-On Function Licences")
  - **>Expert<:**  
Maximum data package (available only via additional licences; see Chap. "19.2 Add-On Function Licences")
- **>Time<:**  
Time of the first daily transmission (factory setting is 00:00).
- **>Cycle Time<:**  
Within one day, several transmissions can take place according to a frequency to be defined. Available are: 15 min, 30 min, 1 h, 2 h, 3 h, 4 h, 6 h, 8 h, 12 h and 24 h.

- **>Event Operation<:**  
Check this box if the transmission is to take place when an event occurs, as an alternative to the specified cycle time.
  - **>Cycle Time Event<:** Possible times to define the frequency: 15 min, 30 min, 1 h, 2 h, 3 h, 4 h, 6 h, 8 h, 12 h and 24 h
- **>Test Settings<:**  
Establish a test connection to the server with the specified values.
- **>Start Data Transfer<:**  
"Manual" data transmission since the last transmitted time stamp (see also Chap. "41.1.10 Preparing the device for data transmission").

### 41.1.9 E-Mail (only with licence)

Transmission to a customer FTP server or to the D2W data portal.

Available as an additional function licence (see Chap. "19.2 Add-On Function Licences" and "40.5.5 Feature Unlock").

Option is available only when MQTT is inactive.

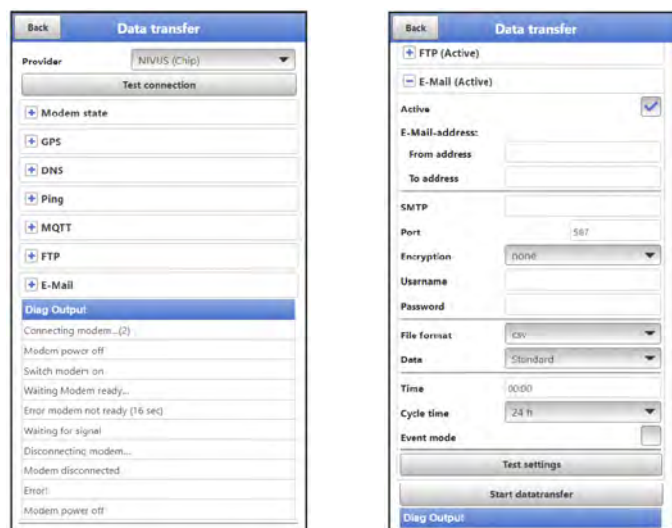


Fig. 41-7 E-Mail active

- **>Active<:**  
Check the box to activate.
- **>E-Mail Address<:**
  - >From<: E-mail sender address (needs to be accepted by the SMTP server)
  - >To<: Enter destination e-mail address
- **>SMTP-Server<:**  
Enter e-mail server name (e. g. mail.gmx.net). Provider must support SMTP (Simple Mail Transfer Protokoll).
- **>Port<:**  
Specify the port of the SMTP outgoing mail server.
- **>Encryption<**  
Can be selected: STARTTLS, SSL or none.
- **>User Name<:**  
Enter the user name of the e-mail box.
- **>Password<:**  
Enter the password of the e-mail box.

- **>Device to Web<:**  
Activate when transmitting to the D2W; the Device-to-Web compatible format is applied.
- **>File Format<:**  
There are csv and txt available.
- **>Data<:**  
Determination of the data depth to be transmitted (see also Chap. "39.2 Menu Data Memory").
  - **>Standard<:**  
Basic data
  - **>Extended<:**  
Extended data package (available only via additional licences; see Chap. "19.2 Add-On Function Licences")
  - **>Expert<:**  
Maximum data package (available only via additional licences; see Chap. "19.2 Add-On Function Licences")
- **>Time<:**  
Time of the first daily transmission (factory setting is 00:00).
- **>Cycle Time<:**  
Within one day, several transmissions can take place according to a frequency to be defined. Available are: 15 min, 30 min, 1 h, 2 h, 3 h, 4 h, 6 h, 8 h, 12 h and 24 h.
- **>Event Operation<:**  
Check this box if the transmission is to take place when an event occurs, as an alternative to the specified cycle time.
  - **>Cycle Time Event<:** Possible times to define the frequency: 15 min, 30 min, 1 h, 2 h, 3 h, 4 h, 6 h, 8 h, 12 h and 24 h
- **>Test Settings<:**  
Establish a test connection to the server with the specified values.
- **>Start Data Transfer<:**  
"Manual" data transmission since the last transmitted time stamp (see also Chap. "41.1.10 Preparing the device for data transmission ").

## 41.1.10 Preparing the device for data transmission

The NivuLink Mobile II transmits data to the NIVUS WebPortal by using the >Start Data Transmission< button. The data can be selected/displayed there. In order for the respective measuring point to be displayed correctly on the overview map in the NIVUS WebPortal, i.e. with the correct GPS coordinates, their setting must be carried out correctly once at the beginning. There is no automatic update during measurement operation.

### Prerequisite

The unit must be positioned so that it has a "clear view" up to the sky. So it is best to do this before placing it in the shaft or a room.

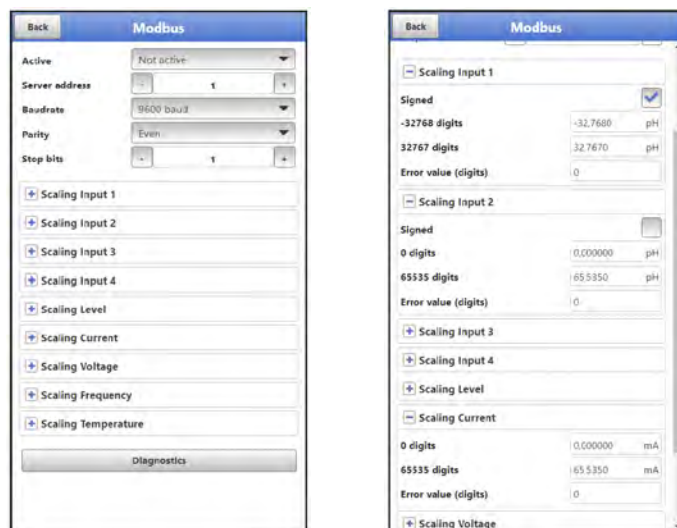
### ➡ Procedure

1. Activate MQTT by checking the box.
2. Click on the button "Get GPS Data" under GPS.  
Wait until the device has searched for the GPS coordinates (latitude/longitude) and these have been entered in the menu. This may well take a few minutes.  
Without these GPS coordinates, the measuring point will not be displayed correctly on the overview map in the NIVUS WebPortal, but the data will be assigned to the correct measurement place in any case.
3. Check whether MQTT or FTP or e-mail has already been activated and parameterised. If not, set the parameters for the corresponding communication path.

- Use the >Start Data Transmission< button to send data once to ensure that the connection is successfully established and the GPS coordinates are transmitted. The NivuLink Micro II can then be positioned in its planned installation location.

## 41.2 Modbus

The data logger can be integrated into other systems via Modbus.



**Fig. 41-8 Modbus / Scaling**

The following functions are available here:

- Active (not active, Client or Server)
- Server address: specify by using the "-" / "+" keys (1 to 247)
- Baud rate (1200, 2400, 4800, 9600, 19200, 38400, 57600 or 115200 Baud)
- Parity (None, Odd or Even)
- Stop bits (1 or 2)

Furthermore, the following scalings can be set (depending on the parameter settings of inputs 1...4):

- Scaling Input 1
- Scaling Input 2
- Scaling Input 3
- Scaling Input 4
- Scaling Level
- Scaling Power
- Scaling Voltage
- Scaling Frequency
- Scaling Temperature

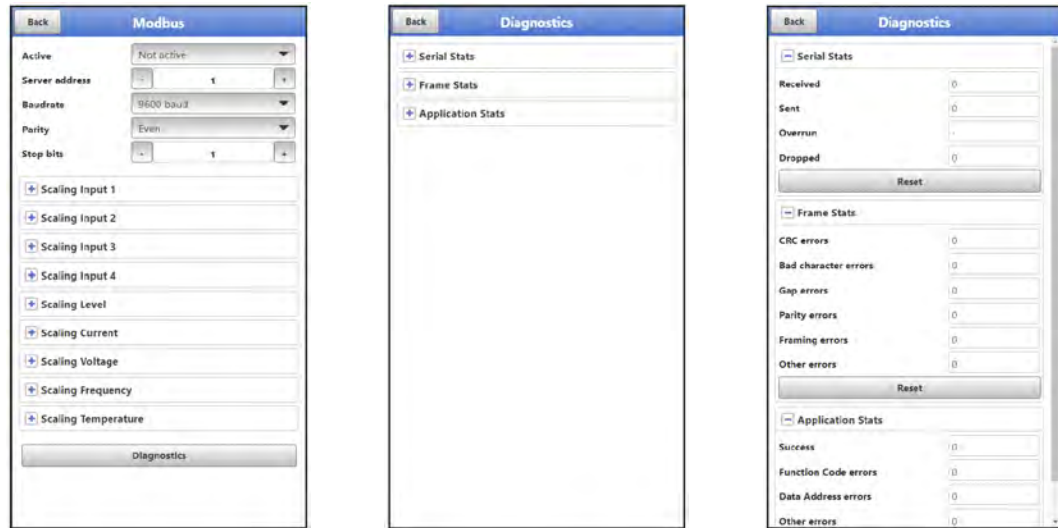
By entering the values for 0 / 65,535 digits (or -32,768 / 32,768 if Signed is ticked, only partly selectable), the resolution of the measuring range is set.

A value must be entered for "Error Value (digits)" (factory setting: "0") in order to communicate an error message when an error occurs.



## Expert knowledge required

These settings require extensive expert knowledge and require the use of NIVUS commissioning personnel or an authorised specialist company.



**Fig. 41-9 Modbus: Scaling / Diagnostics**

Under **>Diagnostics<** the statistics (Serial Stats, Frame Stats and Application Stats) are arranged in layers.

After viewing, a reset is possible in each case.

**Serial Stats** concern the serial interfaces and inform about the number of bytes received, sent and discarded/lost.

**Frame Stats** are about the communication frame and inform about error sources such as the sequence of bytes, checksums, parity, valid packets and other errors.

The **Application Stats** concern the application level and inform about functional errors such as unsuccessful transmissions, unsupported function codes, unoccupied data addresses and other errors.

### 41.3 HTTP

The data logger has a preset user name and password. Both can be changed in this menu here.



See also Chap. "36.2 Change User Name" and "36.3 Change Password".



Fig. 41-10 HTTP

## 42 Parameter Menu Battery

In this menu, the existing (remaining) voltage of the batteries is displayed.



### **Storage tips for the batteries**

*By basically storing and using the batteries at non-critical temperatures (such as room temperature) and storing them dust-free, clean and dry, their capacity can be maintained for longer.*

*This means that even remote data transmission can often still work well at values in the lower capacity range.*



Fig. 42-1 Menu Battery



## 43 Parameter Menu Alarm

The >Alarm< parameter menu is divided into up to six sub-items. These sub-items are >Battery<, >Temperature<, >Input 1<, >Input 2<, >Input 3< and >Input 4<.

The individual sub-items are only visible if the inputs and the digital output have previously been assigned a type under >Application< and thus activated (see Chap. "38.2 Menu Inputs" and "38.3 Menu Digital Output").



For details beyond these operating instructions, on alarm management, alarm messages, alarm overview, status information etc. see also the NIVUS WebPortal manual.

### 43.1 Menu >Alarm< / >Battery (12V)<



**Fig. 43-1 Alarming Battery**

For the >Battery (12V)< sub-item, up to five different threshold values can be entered using the "+" and "-" keys for >Lower Thresholds Entries<. When these are reached, an alarm e-mail (only in connection with the NIVUS WebPortal) is to be issued.

The threshold values are defined by clicking on the fields and typing in numerical values. The data logger sorts the entered threshold values in descending order. This is done independently of the input sequence.

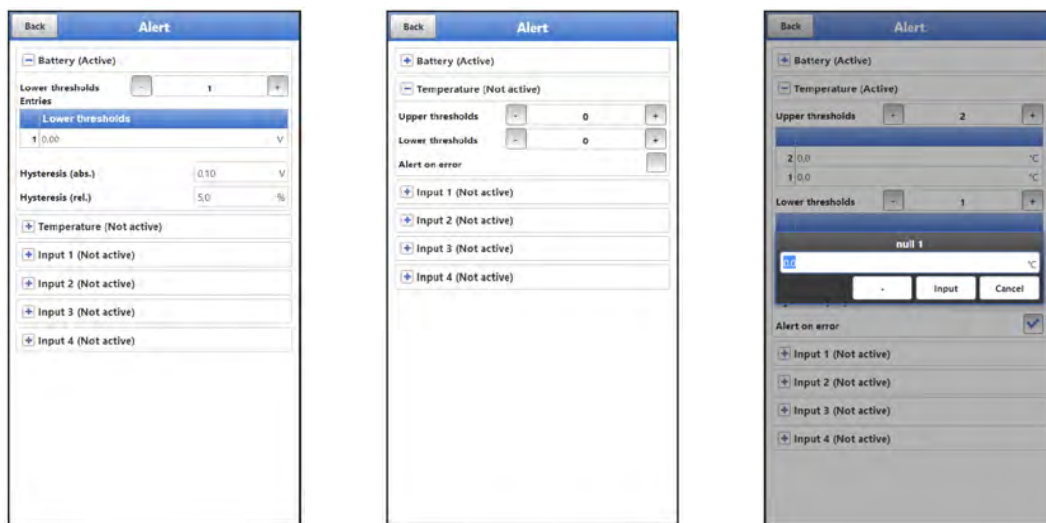
For >Hysteresis (abs.)< and >Hysteresis (rel.)< values can be entered by clicking and typing. The data logger evaluates the two values and sends an e-mail (only in connection with the NIVUS WebPortal) at the highest limit upwards (highest possible value) and at the lowest limit downwards (lowest possible value). This e-mail contains the information that the alarm has been cancelled.

**Default Settings:**

Hysteresis (abs.): 0.10 V

Hysteresis (rel.): 5.0 %

### 43.2 Menu >Alarm< / >Temperature<



**Fig. 43-2 Alarming Temperature**

For the >Temperature< sub-item, up to five different threshold values can be entered using the "+" and "-" keys for >Upper Thresholds Entries< and for >Lower Thresholds Entries<. When these are reached, an alarm e-mail (only in connection with the NIVUS WebPortal) is to be issued.

The threshold values are defined by clicking on the fields and typing in numerical values. The data logger sorts the entered threshold values in descending order. This is done independently of the input sequence.

For >Hysteresis (abs.)< and >Hysteresis (rel.)< values can be entered by clicking and typing. The data logger evaluates the two values and sends an e-mail (only in connection with the NIVUS WebPortal) at the highest limit upwards (highest possible value) and at the lowest limit downwards (lowest possible value). This e-mail contains the information that the alarm has been cancelled.

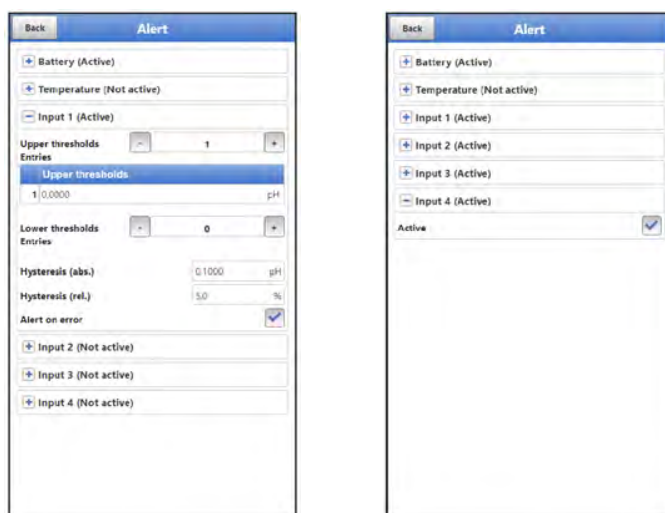
**Default Settings:**

Hysteresis (abs.): 1 °C

Hysteresis (rel.): 5.0 %

In addition, the checkbox >Alert on Error< can be set. Then an alarm e-mail (only in connection with the NIVUS WebPortal) is sent in the event of a malfunction of the integrated temperature sensor. Such errors are e.g. cable faults, interruptions, short circuits etc.

### 43.3 Menu >Alarm< / >Input x<



**Fig. 43-3 Alarming input x / with parameterisation "Digital Input"**

For the >Input 1<, >Input 2<, >Input 3< and >Input 4< sub-items, up to five different threshold values can be entered using the "+" and "-" keys for **>Upper Thresholds Entries<** and for **>Lower Thresholds Entries<** depending on the parameter settings. When these are reached, an alarm e-mail (only in connection with the NIVUS WebPortal) is to be issued.

The threshold values are defined by clicking on the fields and typing in numerical values. The data logger sorts the entered threshold values in descending order. This is done independently of the input sequence.

If the **inputs** are parameterised as **"Digital Input"**, they can be activated. This is done by checking the box. Threshold values cannot be parameterised and no other settings are possible.

For **>Hysteresis (abs.)<** and **>Hysteresis (rel.)<** values can be entered by clicking and typing. The data logger evaluates the two values and sends an e-mail (only in connection with the NIVUS WebPortal) at the highest limit upwards (highest possible value) and at the lowest limit downwards (lowest possible value). This e-mail contains the information that the alarm has been cancelled.

**Default Settings:**

Hysteresis (abs.): depending on the selected type / parameterisation

Hysteresis (rel.): 5.0 %

In addition, the checkbox **>Alert on Error<** can be set. Then an alarm e-mail (only in connection with the NIVUS WebPortal) is sent in the event of an active pending error. Such errors are e.g. cable faults, interruptions, short circuits etc.

## Maintenance and Cleaning

---

**WARNING****Disconnect the System from Mains Power**

Disconnect the unit from the mains (if connected) and secure the higher system against being switched on again before starting maintenance, cleaning and/or repair work (only by qualified personnel).

Disregarding may lead to electric shock.

---

**WARNING****Check danger due to explosive gases**

Before starting assembly, installation and maintenance work, be sure to check that all regulations on safety at work have been observed and that there is no possible risk of explosive gases. Use a gas warner for the check.

When working in the sewer system, make sure that no electrostatic charge can occur:

- Avoid unnecessary movements to reduce the building-up of static charges.
- Discharge any static electricity present on your body before you start installing the sensor.

Disregarding may result in personal injury or damage to the system.

---

**WARNING****Open the device only out of Ex areas**

Do not open, service or repair in an area where an explosive atmosphere is present.

---

**WARNING****Germ Contamination**

Due to the frequent use of the sensors in the waste water sector, parts can be contaminated with dangerous germs. Therefore, appropriate precautions must be taken when coming into contact with cables and sensors.

Wear protective clothing.

---

## 44 Maintenance

### 44.1 Maintenance Interval

The type NivuLink Micro II data logger is conceived as a low-maintenance and low-wear instrument.

Nevertheless, NIVUS recommend an **annual check** of the entire measuring system by the NIVUS customer service.

Depending on the area of application of the measuring system, the maintenance interval may vary. The scope of maintenance and its intervals depend on the following factors:

- Measurement principle of the sensors
- Material wear
- Measurement medium and channel hydraulics
- General regulations for the operator of the measurement system
- Environmental conditions

In addition to the annual maintenance, NIVUS recommend a complete maintenance of the measuring system by the NIVUS customer service after **ten years at the latest**.

Generally, the verification of data loggers and sensors is a basic measure in order to improve operational reliability and to increase the lifetime.

Contact the NIVUS customer service to make an appointment (see Chap. "44.3 Customer Service Information").

## 44.2 Maintenance Tasks

### 44.2.1 Clean, check and replace Seals

#### Basic Maintenance for all Types

The enclosure gaskets of the data logger must be maintained/checked (at least) **every time** the enclosure flap is **closed**:

- Remove foreign bodies and dirt.
- Check elasticity.
- Check for damage.
- Ensure correct fit.
- Treat the seals with silicone grease if necessary.
- Replace defective seals (by NIVUS customer service).

For correct replacement of the seals, NIVUS recommend to return the data logger to NIVUS. Contact the NIVUS customer service to make an appointment (see Chap. "44.3 Customer Service Information").



#### ***Be sure to check the seals regularly***

*Non-compliance may have negative consequences in terms of warranty and liability. See Chap. "5 Warranty" and "6 Disclaimer".*

---


### 44.2.2 Replace batteries

The batteries for the data loggers must not be older than **ten years**. The approved batteries are marked by the battery manufacturer with an indication of the date of manufacture. It must be ensured that the batteries are removed in good time to avoid deep discharge.

⇒ Approved batteries and procedure to replace the batteries see Chap. "47.1 Battery Replacement".



#### ***The following applies to the batteries used:***

- *All batteries used in a device must be date stamped together by the manufacturer and must be new.*
  - *The replacement of individual batteries is not permitted.*
  - *Strict attention must be paid to the correct orientation of the batteries when inserting them.*
  - *All batteries must bear the  mark.*
-

### 44.3 Customer Service Information

For maintenance measures to be carried out by NIVUS, the recommended annual inspection of the entire measuring system or complete maintenance after ten years at the latest, contact our customer service:

**NIVUS GmbH - Customer Centre**

Phone +49 7262 9191-922

[customercenter@nivus.com](mailto:customercenter@nivus.com)

⇒ Observe Chap. "15 Return" prior to returning the data logger to NIVUS GmbH.

## 45 Cleaning

### 45.1 Data Logger

**WARNING**



***Disconnect the System from Mains Power***

*Make sure that the device is disconnected from mains power.*

*Disregarding may lead to electric shock.*

**DANGER**



***Danger by electrostatic Discharge***

*Clean the device only with a damp cloth.*

*In case of disregard, the explosion protection of the device is no longer given due to possible static charge.*

*The device then poses a danger to the life of the user and can cause the ignition of an explosive atmosphere.*

The NivuLink Micro II enclosure complies with protection class IP68 when closed and is not very sensitive. Nevertheless, a high-pressure cleaner should **not** be used for cleaning.

Also, do **not** use harsh cleaning agents or solvents. Instead, it is better to use mild household cleaners or soap suds.

### 45.2 Sensors

Be sure to follow the instructions for maintenance and cleaning of the sensors. These instructions can be found in the respective technical description or instruction manual.

These manuals are provided with the respective sensors and/or are available as download on the NIVUS homepage.

## 46 Dismantling/Disposal

Improper disposal may be harmful to the environment.

- ➡ Dispose of device components and packaging materials in accordance with the applicable local environmental regulations for electrical products:
1. Disconnect the device from mains power, if connected.
  2. Remove connected cables from the device.
  3. Remove batteries and, if they are defective, dispose of them properly.

➡ To open the enclosure or remove the batteries, see also Chap. "47.1 Battery Replacement".

4. Dispose of the data logger properly.



## **EU WEEE Directive**

*This symbol indicates that the requirements of Directive 2012/19/EU on waste electrical and electronic equipment must be observed when disposing of the device. Die NIVUS GmbH support and promote the recycling or environmentally sound, separate collection/disposal of waste electrical and electronic equipment to protect the environments and human health. Observe the local laws and regulations on disposal.*

*NIVUS GmbH is registered with the EAR, therefore public collection and return points in Germany can be used for disposal.*

## **47 Installation of Spare Parts and Wearing Parts**

We expressly draw your attention to the fact that spare parts and accessories which have not been supplied by us have also not been tested and approved by us. The installation and/or use of such products may therefore negatively alter or invalidate the design properties of your measurement system.

NIVUS are not liable for damage caused by the use of non-original parts and non-original accessories.

### **47.1 Battery Replacement**

The batteries for the data logger are **not** rechargeable.

New batteries can be purchased from NIVUS.

#### **Approved Batteries**

The following battery types are currently approved:

- For **Ex Devices**:  
SAFT LSH 20; Li-SOCl<sub>2</sub>; 3.6 V; Type D
- Für **Non-Ex Devices**:  
SAFT LSH 20; Li-SOCl<sub>2</sub>; 3.6 V; Type D  
ULTRALIFE UHR-ER 34615-H; Li-SOCl<sub>2</sub>; 3.6 V; Type D

The batteries can be purchased from a supplier other than NIVUS, too. If applicable, ensure that the traceability of the batteries can be guaranteed by this supplier.

However, only battery types approved in writing by NIVUS are permitted.

In the future, other battery types may be approved.

For more questions contact the NIVUS customer service (see Chap. "44.3 Customer Service Information").



#### **Replacement only by qualified personnel**

*The batteries may only be inserted or replaced by trained personnel.*



#### **Replace all three batteries at the same time**

*All batteries used must be replaced at the same time. The replacement of individual batteries is not permitted.*

### Replacing the used Batteries

➡ Procedure:

1. Open the enclosure flap according to Chap. "22 Open / Close the Data Logger Enclosure".
2. Loosen the eyelet strap (Fig. 47-1 Pos. 1) to secure the batteries at the top and, if necessary, unthread it to remove the batteries (Fig. 47-1 Pos. 2).
3. Insert new batteries and secure each again with the eyelet strap (thread in and fasten again at the top).

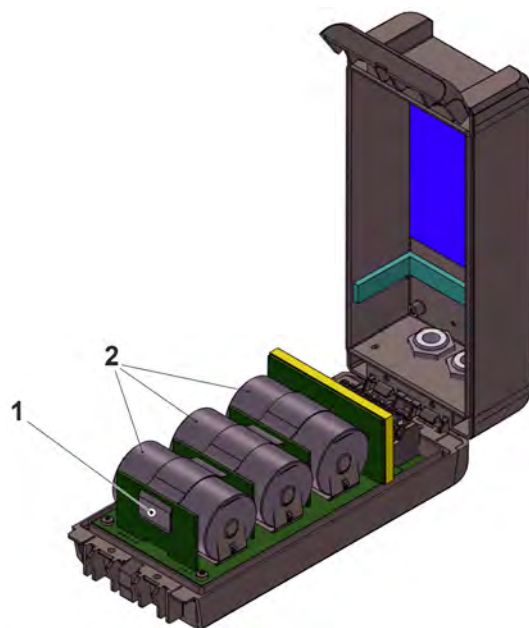


Fig. 47-1 Battery Replacement

## 48 Accessories

Article Number	Description
ZMS0 176	Mounting plate for screwing on/off the data logger
E-AHZ-SCHEL4895	Clamp (attachment to mast; 2x required / pair)
E-KVZ-VERSCHL B9	Locking bolt, diameter 9 mm, length 30 mm
NLG02 ZSE HALT	Suspension bracket for fastening on a step iron
NLG02 ZUB BP	Battery pack (3 pcs.) for use in ATEX-Zone 1
NLG02 ZUB NE	Battery pack (3 pcs.) for use in non-Ex areas
ZUB0 NFM MAGNET	Ring magnet, mounted
NLF0 ANTENNE	Rod antenna 2G/3G/74G, bendable, SMA plug
NLG02 S NETZ 12V	Power adapter for NivuLink Micro II (non-Ex), 12 V / 2 A, input voltage: 85...264 V AC
NLG02 H NETZ 12V	DIN rail power adapter for NivuLink Micro II (non-Ex), 12 V / 2 A, input voltage: 85...264 V AC
ZUB0 KAB RM NLG	Connection cable between NLG data logger and rain gauge (one side with plug, other side with open cable ends)
NLG00 TOOL SET	Tool set, including: 1x USB-Micro data cable 3 m 1x Slot screwdriver 1x Torx screwdriver



	<p><b>NIVUS WebPortal:</b></p> <p>Data management system for storage and provision of measurement data. Multiple options for direct measurement data analysis, system verification, data forwarding and alarming, right up to complete log generation through processing in the cloud. For details, please contact your sales representative.</p>
	<p><b>NIVUS DataKiosk / Data Kiosk Client:</b></p> <p>NIVUS DataKiosk is a web-based connectivity platform for the secure provision of measurement and process data to upstream or downstream systems such as a process control system. Due to its open architecture, NIVUS DataKiosk connects IoT solutions with a wide variety of IT systems and makes necessary data format adaptations.</p> <p>DataKiosk fulfils the function of a gateway. It enables application programmes to read data from a wide variety of devices and pass on control signals to devices on the basis of standardised internet technologies. Through comprehensive networking and automation, processes can be improved overall and their utility can be increased.</p> <p>The NIVUS DataKiosk Client is a graphical interface that retrieves the data from the DataKiosk and automatically stores the result in a configurable location.</p> <p>For details, please contact your sales representative.</p>

**Tab. 9 Spare Parts and Accessories**



More accessories and spare parts can be found in the current NIVUS price list.

---

## Index

<b>A</b>	Accessories .....96	<b>M</b>	Maintenance Interval .....92
	Alarm .....47, 89		Measurement Principles .....24
	Approvals .....101	<b>N</b>	
	Ex Zone 1.....24		Nameplates .....23
<b>B</b>			Names .....3
	Batteries, approved	<b>O</b>	
	for Ex Device.....95		Operation Temperature .....24
	for Non-Ex Device.....95		Operator's Duties.....18
	Buffer Capacitor .....71		Original Instruction Manual.....3
<b>C</b>			Overview.....21
	Certificates .....101	<b>P</b>	
	Cleaning .....94		Power Supply .....24
	Codes .....100		Powerdown.....73
	Colour Code		Precautions.....14
	Wires.....10		Probes, connectable.....23
	Connectable Probes.....23		Product Construction.....21
	Connectable Sensors .....23		Property Rights.....3
	Copyright .....3		Protection ..... 24, 29, 94
	Copyrights .....3	<b>Q</b>	
	Credits .....100		Qualified Personnel .....18
	Customer Centre .....94	<b>R</b>	
<b>D</b>			Repeated measurement of the same
	Device ID .....23		measurement places .....51
	Device Versions .....26		Restart .....73
	Disclaimer.....16		Return .....20
<b>E</b>		<b>S</b>	
	Enclosure .....24		Safety Measures.....14
	Error Messages .....47, 72		Scope of Delivery .....19
<b>G</b>			Sensor Types .....36
	Germs.....15, 92		Sensors, connectable .....23
<b>H</b>			Service Level .....73
	Humidity.....25		Spare Parts.....95
<b>I</b>			Specifications .....24
	Inspection upon Receipt.....19		Storage .....19
	Installation .....28		Storage Temperature .....25
	Intended Use .....17		System Time.....71
	Interface	<b>T</b>	
	Micro-USB.....17		Translation .....3
<b>L</b>			Transport .....19
	Licences .....100	<b>W</b>	
	Licensing Issues.....100		Wake-Up
			Windows.....44
			Warranty .....16

Wearing Parts.....	95
Wires	
Colour Code.....	10

## Credits and Licenses

### 49 List of Sources of the Licences and Codes used

The data logger type NivuLink Micro II uses code from the following open source projects:

- Freetype (<http://www.freetype.org>)
- Libharu (<http://libharu.org>)
- Libjpeg (<http://www.ijg.org>)
- Libpng (<http://www.libpng.org>)
- Zlib (<http://www.zlib.net>)
- Mini-XML (<http://www.msweet.org>)
- Nano-X/nxlib (<http://www.microwindows.org>)
- FLTK (<http://www.fltk.org>)
- Appendix1: LGPL
- Appendix2: MPL



#### **Licensing Issues**

*For questions on licensing contact [opensource@nivus.com](mailto:opensource@nivus.com)*

---

## Approvals and Certificates

DE / EN / FR

**EU Konformitätserklärung***EU Declaration of Conformity**Déclaration de conformité UE*

Für das folgend bezeichnete Erzeugnis:

*For the following product:**Le produit désigné ci-dessous.*

NIVUS GmbH  
Im Täle 2  
75031 Eppingen

Telefon: +49 07262 9191-0  
Telefax: +49 07262 9191-999  
E-Mail: info@nivus.com  
Internet: www.nivus.de

<b>Bezeichnung:</b>	<b>Portabler Datenlogger NivuLink Micro II</b>
<i>Description:</i>	<i>Portable data logger NivuLink Micro II</i>
<i>Désignation:</i>	<i>Enregistreur de données portable NivuLink Micro II</i>
<b>Typ / Type:</b>	<b>NLG02</b>

erklären wir in alleiniger Verantwortung, dass die auf dem Unionsmarkt ab dem Zeitpunkt der Unterzeichnung bereitgestellten Geräte die folgenden einschlägigen Harmonisierungsvorschriften der Union erfüllen:

*we declare under our sole responsibility that the equipment made available on the Union market as of the date of signature of this document meets the standards of the following applicable Union harmonisation legislation:*

*nous déclarons, sous notre seule responsabilité, à la date de la présente signature, la conformité du produit pour le marché de l'Union, aux directives d'harmonisation de la législation au sein de l'Union:*

- 2014/53/EU
- 2011/65/EU

Bei der Bewertung wurden folgende einschlägige harmonisierte Normen zugrunde gelegt bzw. wird die Konformität erklärt in Bezug auf die nachfolgend genannten anderen technischen Spezifikationen:

*The evaluation assessed the following applicable harmonised standards or the conformity is declared in relation to other technical specifications listed below:*

*L'évaluation est effectuée à partir des normes harmonisées applicable ou la conformité est déclarée en relation aux autres spécifications techniques désignées ci-dessous:*

- EN 61010-1:2010 + A1:2019 + A1:2019/AC:2019
- EN 61326-1:2013
- Draft ETSI EN 301 489-19 V2.2.1
- EN 301 511 V12.5.1 (GSM/2G)
- EN 301 908-2 V13.1.1 (UMTS/3G)
- Final draft ETSI EN 303 413 V1.2.1 (GNSS)
- EN 62311:2008
- EN 301 489-1 V2.2.3
- Draft ETSI EN 301 489-52 V1.2.1
- EN 301 908-1 V15.2.0 (UMTS/3G, LTE/4G)
- EN 301 908-13 V13.2.1 (LTE/4G)

Diese Erklärung wird verantwortlich für den Hersteller:

*This declaration is submitted on behalf of the manufacturer:*

*Le fabricant assume la responsabilité de cette déclaration:*

**NIVUS GmbH**  
**Im Täle 2**  
**75031 Eppingen**  
**Germany**

abgegeben durch / *represented by / faite par:*

**Ingrid Steppe** (Geschäftsführerin / *Managing Director / Directeur général*)

Eppingen, den 21.10.2022

Gez. *Ingrid Steppe*

## UK Declaration of Conformity

NIVUS GmbH  
Im Tale 2  
75031 Eppingen

Telefon: +49 07262 9191-0  
Telefax: +49 07262 9191-999  
E-Mail: info@nivas.com  
Internet: www.nivas.de

For the following product:

<b>Description:</b>	<b>Portable data logger NivuLink Micro II</b>
<b>Type:</b>	<b>NLG02</b>

we declare under our sole responsibility that the equipment made available on the UK market as of the date of signature of this document meets the standards of the following applicable UK harmonisation legislation:

- SI 2017 / 1206 The Radio Equipment Regulations 2017
- SI 2012 / 3032 The Restriction of the Use of Certain Hazardous Substances in Electrical and Electronic Equipment Regulations 2012

The evaluation assessed the following applicable harmonised standards or the conformity is declared in relation to other technical specifications listed below:

- BS EN 61010-1:2010 + A1:2019 + A1:2019/AC:2019
- BS EN 61326-1:2013
- Draft ETSI EN 301 489-19 V2.2.1
- BS EN 301 511 V12.5.1 (GSM/2G)
- BS EN 301 908-2 V13.1.1 (UMTS/3G)
- Final draft ETSI EN 303 413 V1.2.1 (GNSS)
- BS EN 62311:2008
- BS EN 301 489-1 V2.2.3
- Draft ETSI EN 301 489-52 V1.2.1
- BS EN 301 908-1 V15.2.0 (UMTS/3G, LTE/4G)
- BS EN 301 908-13 V13.2.1 (LTE/4G)

This declaration is submitted on behalf of the manufacturer:

**NIVUS GmbH**  
**Im Tale 2**  
**75031 Eppingen**  
**Germany**

represented by:

**Ingrid Steppe** (Managing Director)

Eppingen, 21/10/2022

Signed by *Ingrid Steppe*

EU Declaration of Conformity NivuLink Micro II Ex (follows with next document revision)

EU Type Examination Certificate (follows with next document revision)