



Instruction Manual

Ri-Series Sensor

Intelligent Radar Sensor

Document Revision 00 / 29.06.2023

Original Instruction Manual: German / Rev. 00 / 06.06.2023

COPYRIGHT

All rights reserved. No part of this publication may be reproduced, transmitted, transcribed, stored in a retrieval system, or translated into any language in any form without the written permission of NIVUS GmbH.

WARRANTY AND LIABILITY

NIVUS GmbH guarantees for a period of 2 years from the date of delivery that it will either exchange or repair any part of this product returned to NIVUS in Eppingen if it is found to be defective in material or workmanship, subject to the defect not being due to unfair wear and tear, misuse, modification or alteration, accident, misapplication, or negligence.

DISCLAIMER

NIVUS GmbH neither gives nor implies any process guarantee for this product and shall have no liability in respect of any loss, injury or damage whatsoever arising out of the application or use of any product or circuit described herein.

Every effort has been made to ensure accuracy of this documentation, but NIVUS GmbH cannot be held liable for any errors.

NIVUS GmbH operates a policy of constant development and improvement and reserve the right to amend technical details, as necessary.

The Ri-Series sensor shown on the cover of this manual is used for illustrative purposes only and may not be representative of the actual Ri-Series sensor supplied.

CONTACT

For technical support, please contact:

NIVUS GmbH - Customer Centre

Phone +49 7262 9191-922

customercenter@nivus.com

CONTENTS

Chapter 1: Start Here.....	6
About this Manual	6
About the NIVUS Ri-Series Radar Sensor.....	7
Functional Description	7
Product Specification.....	9
Chapter 2 Installation.....	11
Unpacking	11
Power Supply Requirements.....	11
Dimensions	12
Outdoor and Open Vessel Installation	14
Closed Vessel Installation	15
Cable	16
Typical wiring Ri-Series sensor	16
Preparation for Operation	17
Maintenance	18
Hazardous Area Installation.....	18
Chapter 3 How To Use The NIVUS Ri-Series Radar Sensor	21
4-20 mA Device	21
Accessing Parameters.....	21
HART Commands.....	21
NIVUS Ri-Series Radar Sensor Connection.....	21
Chapter 4 – Ri-Series Bluetooth and PC Connectivity.....	23
Ri-Series Bluetooth.....	23
Connect Smartphone/Tablet via Bluetooth	23
Connecting PC/Laptop via Bluetooth	29
Connection NIVUS Ri-Series Radar Sensor.....	29
Start Page of the web-based User Interface	30
Trace Page.....	33

Parameters Page.....	36
NIVUS Ri-Series Software	39
NIVUS Opening the Ri-Series Software.....	43
NIVUS Ri-Series Software Start Screen.....	45
Menu Bar	46
Shortcut Icons.....	47
Toggle/Update changed Parameter List.....	50
Main Screen Selection Tabs.....	50
Main Screen.....	51
Progress Bar	58
Cursor Position.....	59
Sensor	59
Quick start setup	59
Setting up Your Application.....	60
Defining Setting Security/Passcodes.....	61
Reset to Default Setting	61
Chapter 5 Parameter Listing and Description	62
Application.....	62
Operation	62
Cause Description for critical Error Messages (CRITICAL (RED)).....	66
Distance	66
Data Logs	67
mA Output.....	69
mA Failsafe.....	70
Compensation	70
Stability.....	72
System	73
DATEM.....	76
Volume Conversion	78
Breakpoints.....	82

Tables.....	84
Chapter 6 Troubleshooting.....	85
Chapter 7 Disposal.....	86
Transducers	86
Controllers.....	86
Chapter 8 Certificates and Approvals.....	87

CHAPTER 1: START HERE...

Congratulations on your purchase of a NIVUS Ri-Series Intelligent Radar Sensor Level Monitoring System. This quality system has been developed over many years and represents the latest in high technology Radar level measurement and control. It has been designed to give you years of trouble-free performance, and a few minutes spent reading this operating manual will ensure that your installation is as simple as possible.

About this Manual

It is important that this manual is referred to for correct installation and operation. There are various parts of the manual that offer additional help or information as shown.

Tips



TIP: Look for this symbol throughout this NIVUS manual to find helpful information and answers to frequently asked questions.

Additional Information

Additional Information

At various parts of the manual, you will find sections like this that explain specific things in more detail.

About the NIVUS Ri-Series Radar Sensor



Functional Description

The NIVUS Ri-Series radar sensor is a highly developed RADAR level measurement system which provides non-contacting level measurement for a wide variety of applications in both liquids and solids. Its unique design gives unrivalled performance in echo discrimination and accuracy in a loop powered device.

Housed within a robustly engineered enclosure, the NIVUS Ri-Series radar is designed for easy installation. The integral levelling indicator ensures optimal setup with liquids and Bluetooth radio allows local setup and monitoring via any device with a Bluetooth enabled browser (i.e., Google Chrome and Microsoft Edge on a PC or Android, and BlueFy Web BLE Browser on iOS).

The primary system communication is via HART modem over 4-20 mA loop. For further information on setting up Radar with a controller please consult the NIVUS customer centre for assistance.

It gives all the advantages associated with radar technology and offers best-in-class performance with a narrow beam angle. The range is 0.075 to 8 metres or up to 20 metres. The signal emanates from the curved face of the radar, but for the purposes of measurement it is measured from the front edge of the body.

 If using the sensor version with front thread, the empty distance measured from the face of the adaptor to the material being measured requires an offset of 38 mm (1.5"). To perform this offset, use P851 (measurement offset) and set the value of this parameter to -38 mm (-1.5").

Easy calibration and maintenance free "fit and forget" performance mean that you can install the NIVUS Ri-Series radar sensor level monitoring system rapidly and with confidence.

Calibration is done with NIVUS Ri-Series software via a HART modem (e.g. *ZUBO HART BOX 04*).

The NIVUS Ri-Series radar sensor operates on the FMCW Radar principle and uses 'state of the art' echo extraction technology.

The Sensor operates on the principle of timing the echo received from a measured pulse of sound transmitted in air and utilises "state of the art" echo extraction technology.

The intelligent sensor comes in two models:

1. R8 with a measurement range from 0.075 m (0.24 feet) to 8.00 m (26.24 feet).
2. R20 with a measurement range from 0.075 m (0.24 feet) to 20.00 m (65.62 feet).

These are each available in cable lengths of 5, 10, 20, 30, 50 or 100 m length, with a range of mounting brackets also available.

All types can be mounted via a 1" BSP thread on the rear. There is also a model that can be ordered with an optional front thread mounting being available (see [Chapter 2 Installation](#) for further details).

All types are available for use in hazardous area installations; zones 0, 1, 2 (gas) and zones 20, 21 and 22 (dust). All with ATEX & IECEx certification.

The sensor can be ordered with a front thread for direct connection to a process and is suitable for both BSP and NPT connections.

As the sensor has been designed predominantly for use in water and wastewater applications, the front thread offers reliable mechanical connection to both BSP and NPT threads.

The sensor has a 4 to 20 mA output which can be programmed to give an output proportional to **level, space, distance or volume**, dependant on the measurement mode selected and provides a 'error condition' alarm of either 3.8 mA or 22 mA.

Product Specification

PHYSICAL

Dimensions & Mounting	All models: 135 x 102 mm (5.31 x 4.04"); rear thread 1" BSP/NPT with 1" NPT nuts or 1.5" BSP/NPT front thread
Mounting Options	ANSI or front thread with DIN flange (PVDF)
Weight	All versions: 1.5 kg (without cable)
Frequency	All versions: V-Band (63 GHz)
Enclosure material/description	Valox 357U
Transducer cable requirements	2-wire screened
Cable Lengths	5, 10, 20, 30, 50 or 100 m

ENVIRONMENTAL

Enclosure protection (all models)	IP68
Max. / min. temperature (electronics)	-40 °C to +80 °C
Vibration Protection	Fully potted
Humidity	0 to 99 % (non condensing)
Process Pressure	-1 to +3 bar
CE Approval	See EU Declaration of Conformity
UKCA Approval	See UK Declaration of Conformity
Regulatory Approvals	FCC, RED, CE, UKCA, IECEx, ATEX, UKEx
FM Approval	Pending
Radio Approval	EN 302729 (level probing radar), FCC Part 15C
ATEX / Ex	Zones 0, 1, 2: Ex II 1 G Ex ia IIC T4 Ga, T _{amb.} = -40 °C to +80 °C Zones 20, 21, 22: Ex II 1 D Ex ia IIIC T100 °C Da, T _{amb.} = -40 °C to +80 °C
WEEE and ROHS	Compliant

SERVICE

Measurement Range	R8: 0.075...8.00 m R20: 0.075...20.00 m
Accuracy/Repeatability	All models: ±2 mm
Repeatability	All models: ±1 mm
Beam Angle	All models: 6°
First Stable Measurement	Cold Boot = 10 seconds Warm Boot = 5 seconds

OUTPUTS

Digital Communications	HART with DTM
Communication Protocol	HART 7
Analogue	4-20 mA loop powered, output resolution 1 µA
User Indicator	Quad-colour LED lights with tilt sensor

PROGRAMMING

PC Programming (via HART modem)	NIVUS Ri-Series software and HART modem (e.g. <i>ZUBO HART BOX 04</i>) (for setup, installation, echo profiles and troubleshooting)
Programming (via Bluetooth)	NIVUS Ri-Series HTML Application/Webpage
Local Wireless Communication	Encrypted Bluetooth with mobile interface (ability to disable)
Wireless Range	4...40 m; user configurable
Program security	Via passcode
Programmed data integrity	Via non-volatile RAM
PC Setup and monitoring	Compatible with Win 7, Win 8 and Win 10
DTM (Device Type Manager)	For PACTware

SUPPLY

Power supply	12 V min. (mA loop with $R_s = 0 \Omega$) 16 V min. (HART $R_s = 250 \Omega$) 28 V DC max.
Power supply	Resolution 3.8...22 mA
Current Consumption	Current consumption at start-up = 20 mA

ACCESSORIES

ZUBO HART BOX 04	HART modem with integrated USB sensor power supply
-------------------------	--

CHAPTER 2 INSTALLATION

Unpacking

Important Notice

All shipping cartons should be opened carefully. When using a box cutter, do not plunge the blade deeply into the box, as it could potentially cut or scratch equipment components. Carefully remove equipment from each carton, checking it against the packing list before discarding any packing material. If there is any shortage or obvious shipping damage to the equipment, report it immediately to NIVUS GmbH.

Power Supply Requirements

The intelligent sensor operates from a DC supply of 12...28 V and will typically draw less than 22 mA.

The compact one-piece construction of the sensor can be mounted easily using either the 1" BSP rear mounting thread and the accompanying 1" nuts, or the 1.5" BSP front nose thread attachment (order the according sensor version).

When choosing a location to mount the sensor, bear in mind the following:

- The sensor's signal path should be free of falling material and obstructions such as pipes, beams etc.
- The sensor should be mounted at least 7.5 cm (0.25 feet) above the maximum level of the material and be perpendicular to the surface.
- The ambient temperature is between -40 °C and 80 °C.
- There should be no high voltage cables or electrical inverter wiring near the transducer cabling.

Important Notice

All electronic products are susceptible to electrostatic shock, so follow proper grounding procedures during installation.

Dimensions

The dimensions of the NIVUS Ri-Series sensors are shown below:

Rear Thread Mount

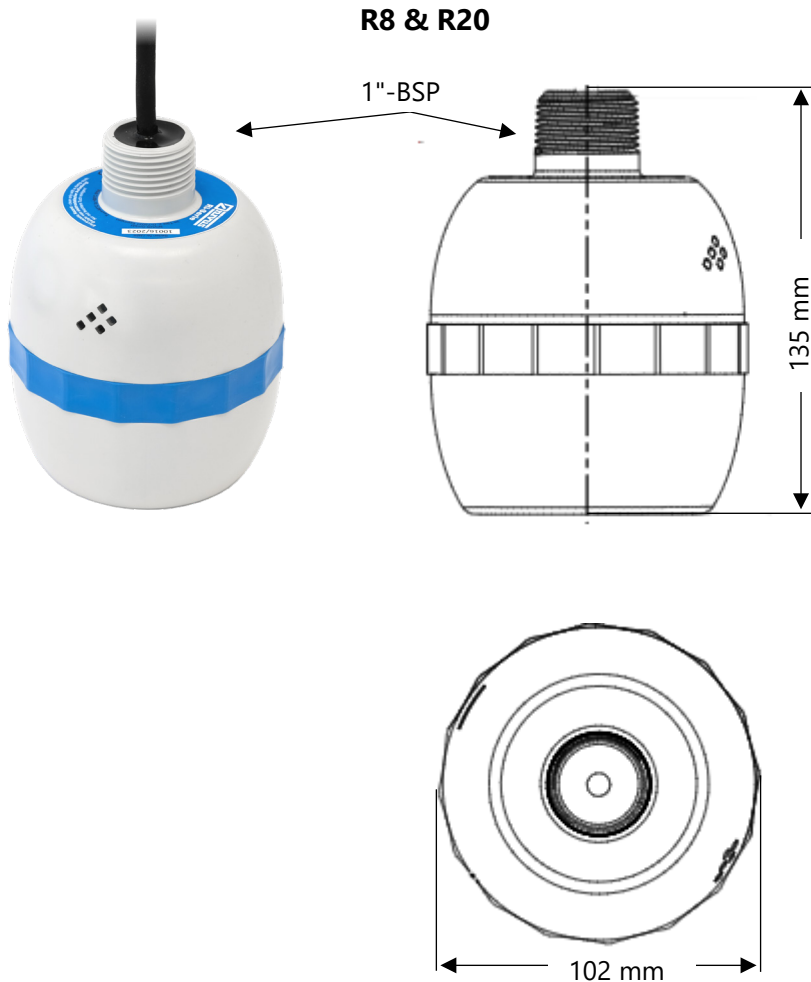

Front Thread Mount



R8 & R20

1"-BSP

1.5"-BSP

38 mm

173 mm

102 mm

Important Notice

The diagrams shown are for illustrative purposes only.

Outdoor and Open Vessel Installation

The intelligent sensor can be simply mounted on a bracket, suitable for the application and secured using either the 1" BSP rear thread with 1" nuts or via the 1.5" BSP front thread, dependant on model.

TYPE	RANGE	L = BLANKING
R8	8 metres (26.24 feet)	0.075 m (0.25 feet)
R20	20 metres (65.61 feet)	0.075 m (0.25 feet)

"L" (Blanking) should, as a minimum be at least that as detailed in the table above but can be greater if required.

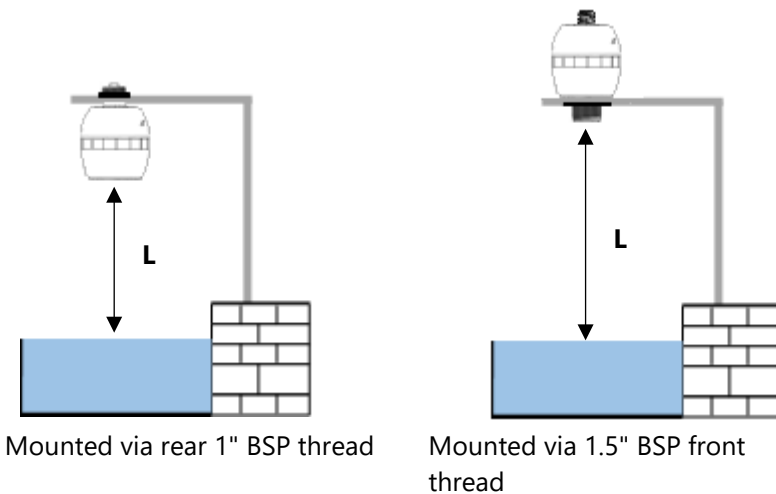

Closed Vessel Installation

"L" should be at least that as detailed in the table above but can be greater if required. The sensor can be simply screwed into a flange and secured using the rear 1" BSP rear thread with 1" nuts or via the 1.5" BSP front thread, dependant on model.

Where a flange and/or gasket is used, ensure chemical compatibility of the materials used. In cases where a metal flange is used it is advisable to fit a suitable gasket between the flange of the sensor and the connection to the vessel.

Standpipe Installations

When mounting the sensor to a standpipe care should be taken to ensure that the standpipe is of sufficient diameter with reference to its length (see the table below for details):

DIA. (D)		MAX LENGTH	
mm	inches	mm	inches
100	4	300	12
150	6	420	16
200	8	560	22

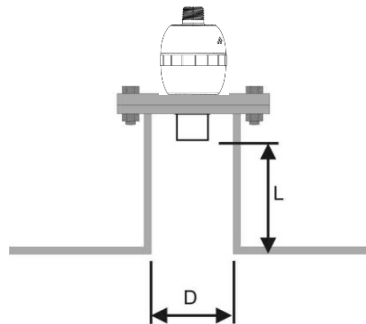

Sensor mounted via front thread

When using a standpipe, fixed to the top of a vessel, ensure that the open end of the standpipe is clear of any obstructions such as weld seams, gas-gaskets etc. to avoid unwanted signal returns.

If using standpipes which extend into the vessel, beyond the blanking distance, but not as far as the empty level, then the open end of the standpipe should be cut to an angle of 45°.

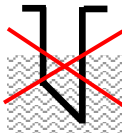

The maximum level (100 % of span) is inside the blanking distance.

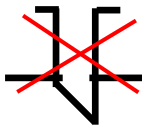

Pipe should be free of obstructions such as weld seams.



Correct standpipe installation.

Cable

The intelligent sensor is supplied with a fixed cable. If this cable is extended then the total capacitance must not exceed the limits for the voltage applied.

Typical wiring Ri-Series sensor

The HART modem and PC are used to set up the operation parameters for the sensor. The output can either be programmed as a 4-20 mA current giving level or distance or as a digital signal via a HART master.

The sensor cable is a twisted pair with overall cable screen. The twisted pair are red and black. Connect the red wire to + and the black one to -. The screen should go to signal ground.

Loop Resistance

For two wire operation, the maximum cable resistance allowable can be calculated from the graph below. For example, if a sensor is supplied with 24 V, the maximum total resistance of the cable is 650 ohms. For a typical cable with 77 ohms/km, this would mean a maximum cable length of $650/77 = 8.4$ km. Since this is the total cable resistance, it must be divided by 2 to get the maximum distance of 4.2 km.

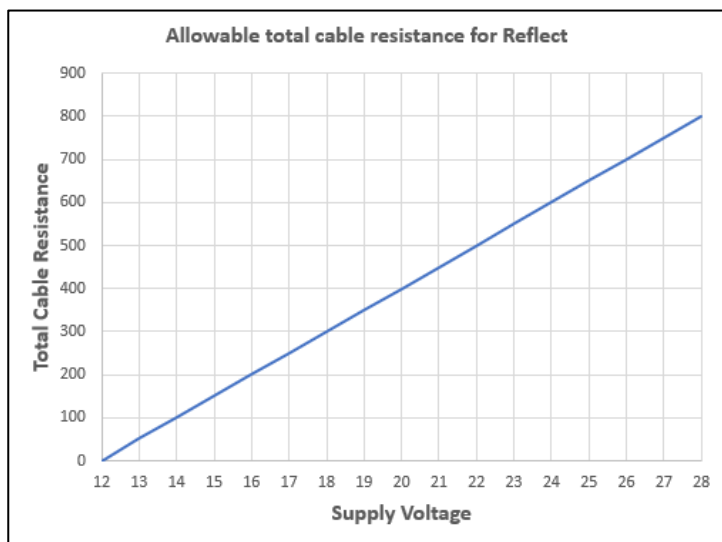

Maximum cable resistance vs supply voltage.

Important Notice

If the equipment is installed or used in a manner not specified in this manual, then the protection provided by the equipment may be impaired.

Preparation for Operation

Before switching on, check the following:

- ✓ The intelligent sensor is mounted correctly.
- ✓ The power supply is correctly installed.

- ✓ Any controlled equipment, e.g., motors, are in a safe and monitored state.

Maintenance

There are no user serviceable parts inside the intelligent sensor. If you have any problems with the unit, please contact the NIVUS GmbH.

To clean the equipment, wipe with a damp cloth. Do not use any solvents on the enclosure.

Hazardous Area Installation

Information specific to Hazardous Area Installation

**(Reference European ATEX Directive 2014/34/EU, Annex II, 1.0.6.)/
UK Statutory Instrument 2016/1107)**

The following information applies to equipment covered by certificate number CML 23ATEX2104X (ATEX Ex ia), IECEx CML23.0039X (IECEx Ex ia).

Zones 0, 1, 2: Ex II 1 G Ex ia IIC T4 Ga, $T_{amb.} = -40\text{ °C to }+80\text{ °C}$

Zones 20, 21, 22: Ex II 1 D Ex ia IIIC T100°C Da, $T_{amb.} = -40\text{ °C to }+80\text{ °C}$

1. The equipment may be used with flammable gases and vapours of gas groups IIC, IIB, and IIA with temperature classes T1, T2, T3, T4 and a maximum ambient temperature range of $-40\text{ °C to }+80\text{ °C}$.
2. The equipment is only certified for use in ambient temperatures in the range $-40\text{ °C to }+80\text{ °C}$ and should not be used outside this range.
3. Installation shall be carried out in accordance with the applicable code of practice by suitably trained personnel.
4. Repair of this equipment shall be carried out in accordance with the applicable code of practice.
5. If the equipment is likely to meet aggressive substances, then it is the responsibility of the user to take suitable precautions that prevent it from being adversely affected, thus ensuring that the type of protection is not compromised.
 - Aggressive substances - e.g., acidic liquids or gases that are acids, solvents or alkaline that attack metals or polymeric materials.
 - Suitable precautions - e.g., regular checks as part of routine inspections or establishing from the material's data sheet that it is resistant to specific chemicals.

6. The certificate number has an "X" suffix that indicates that the following special condition of certification applies:
In the case of the sensor, due to the housing and labels being non-conductive plastic, care needs to be taken with regards electrostatic charge. The equipment shall not be installed if the conditions are conducive to the build-up of electrostatic charge. Additionally, the equipment should only be cleaned with a damp cloth.
7. NIVUS GmbH point out that, on being put into service, the equipment must be accompanied by a translation of the instructions in the language(s) of the country in which the equipment is to be used.

Hazardous Area Specific Power Supply and barrier Requirements

The intelligent sensor operates from a DC supply of 12 to 28 V and will typically draw less than 22 mA.

In the case of the Ex ia version the unit must be powered from an approved I.S. safety barrier or approved I.S.

Power supply with the following limits:

$U_i = <28 \text{ V}$, $I_i = <162 \text{ mA}$, $P_i = <0.85 \text{ W}$

Important Notice

The Ri-Series sensors can also be connected to the NivuFlow Mobile, NivuLevel Mobile, NivuLink Micro II and iXT0 units, provided the respective types have ATEX approval.

CAUTION, the sensor then has max. the same Ex level as the transmitter used (example: transmitter has approval for zone 1 -> the sensor approval zone 0 becomes invalid - here the sensor can only be used in zones 1/2).

When installing in hazardous areas always check the label for approval details (see below):



Hazardous Area Installation

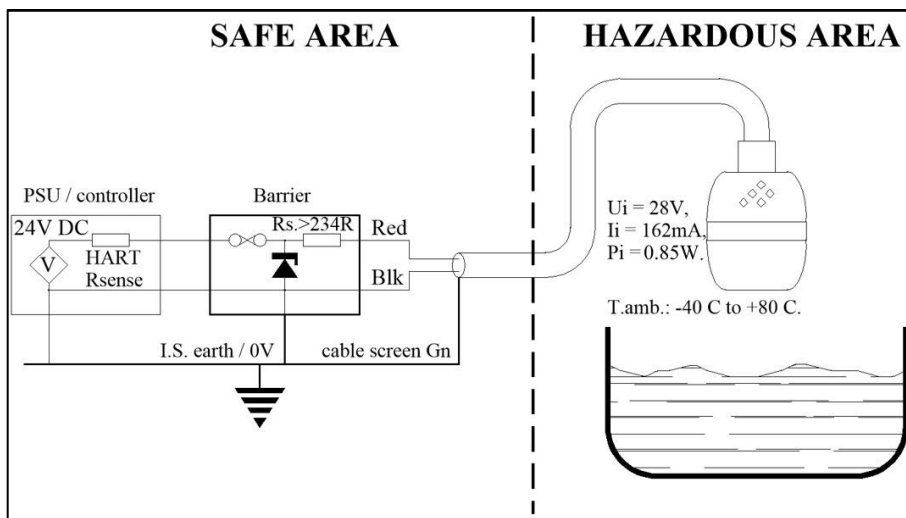

CABLE COLOUR	DESCRIPTION	COMMENTS
Red	DC Power +Ve	+12 V to +28 V DC max.
Black	DC 0 V / Ground	Connect to the same point
Green	Cable Screen	

Important Notice

A barrier with rated nominal resistance of $R_s \leq 250 \Omega$ is advised for optimum performance.

CHAPTER 3 HOW TO USE THE NIVUS RI-SERIES RADAR SENSOR

4-20 mA Device

If setting the measurement mode to **Level** the 4-20 mA output will be proportional to the **level** being seen, with respect to the maximum range and span of the sensor model being used as detailed in the table below.

	R 8	R 20
4 mA (empty) 0 % of span distance from the sensor face in metres	8.00	20.00
20 mA (full) 100 % of span distance from the sensor face in metres	0.075	0.075

Accessing Parameters

To view or change parameters values one of the following methods must be used:

HART Commands

If familiar with the use of HART protocol and the sensor is connected to a HART modem, then it can be programmed following normal HART procedures.

Commands implemented by the intelligent sensor are as follows:

Universal

0, 1, 2, 3, 6, 7, 8, 9, 11, 12, 13, 14, 15, 16, 17, 18, 19, 20, 21, 22, 38 and 48.

Common practice

33, 34, 35, 40, 41, 42, 44, 45, 46, 47, 83, 89, 90 and 122.

NIVUS Ri-Series Radar Sensor Connection

The sensor comes complete with the ability to connect to a Bluetooth HTML page (see [Chapter 4 – Ri-Series Bluetooth and PC Connectivity](#)).

Alternatively use the free NIVUS Ri-Series software, which, when used with a HART Modem, (see [Chapter 2 Installation](#) for full details on how to connect the modem), can be used to carry out the programming of the intelligent sensor.

Download the software from the NIVUS website onto the PC intended to be used to carry out the programming of the sensor. Install the software by following the on-screen instructions.

CHAPTER 4 – RI-SERIES BLUETOOTH AND PC CONNECTIVITY

Ri-Series Bluetooth

The NIVUS Ri-Series radar sensor has the capability to connect to your smartphone (Android and Apple iOS), tablet, laptop or PC via a Bluetooth connection. When connected you can view and change parameters, check level measurements and view live echo traces.

For security reasons, the Bluetooth range may be reduced from 40 m to as little as 4 m or disabled altogether.

Important Notice

Bluetooth Requirements: Any device with Bluetooth 4.0 and above

PC: Chrome or Edge browser

Android: Chrome or Edge browser (**FREE**)

iOS: Download "Bluefy – Web BLE Browser" from App store (**FREE**).

You will then need to type in the web address of the web-based user interface into the browser.

The NIVUS Ri-Series radar sensor user interface utilises a HTML page which can be used even when there is no internet connection available. There is no need for any modem or interconnecting cable, as the intelligent sensor can be setup when it is powered on and in situ in your application.

Connect Smartphone/Tablet via Bluetooth

Important Notice

Ensure that the sensor is powered prior to making a connection to the NIVUS Ri-Series radar sensor user interface.

Enable Bluetooth on your smartphone/tablet.

Enter the web address <https://www.nivus.de/ri-app> into your browser and press enter to search for the page.

Alternatively, you can use the QR code below:



Whether using the QR code or the web address of the web-based user interface, when selected you will be directed to the NIVUS Ri-Series radar sensor Bluetooth start page from where a connection to the sensor can be made.

Important Notice for iOS Devices

If using an **iOS device**, please scan the QR code and copy the URL link using your share button and paste to the BlueFy App to access the web-based user interface.

To have the web-based user interface available at all times, you can create a **shortcut** on your home screen.

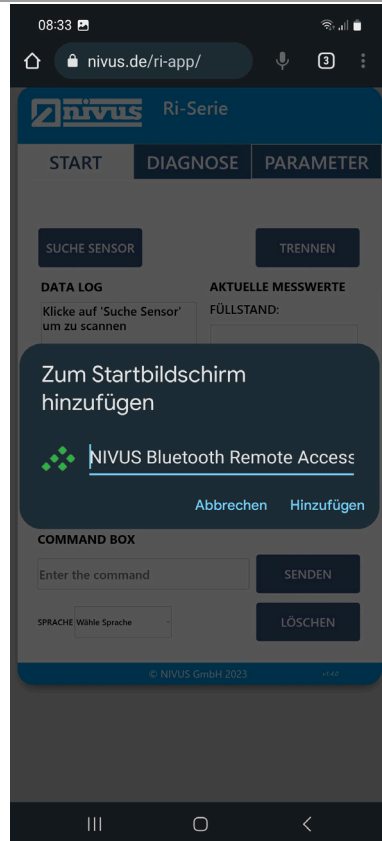
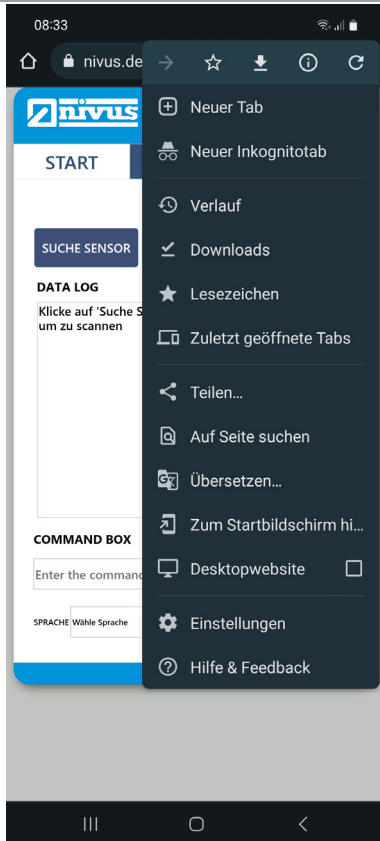

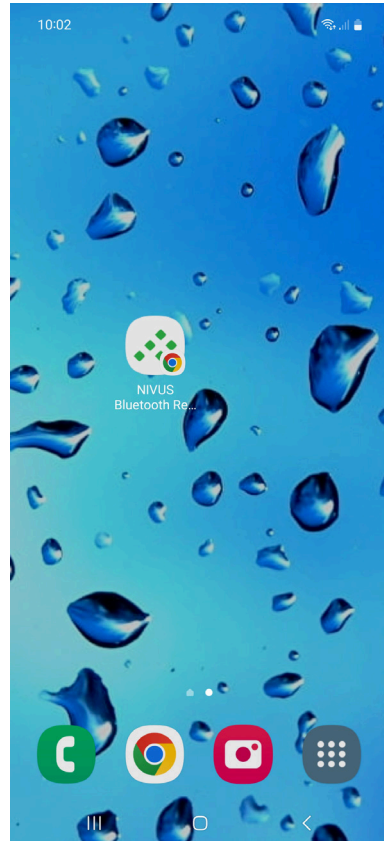
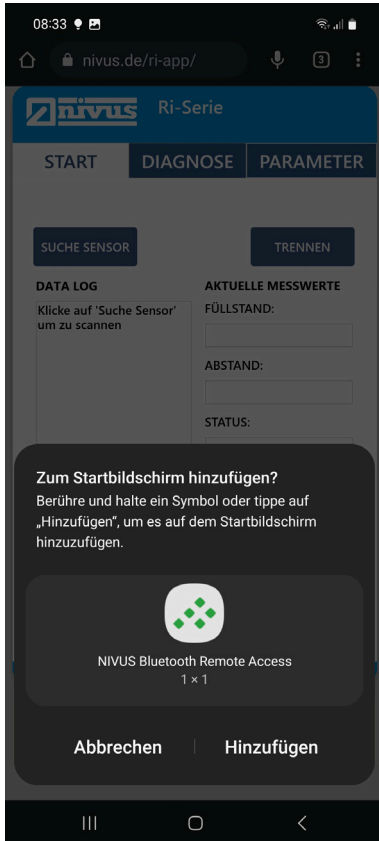

Start application (open shortcut).

Select the **DEVICE SCAN** button to begin scanning for your intelligent sensor. If the sensor is not recognised, the smartphone/tablet still needs the permissions to pair the Bluetooth devices. Therefore, update permissions.

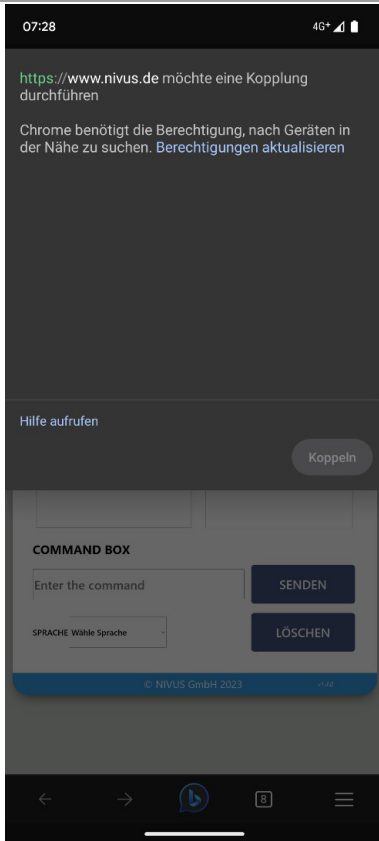

As soon as the sensor (4-digit number / serial number) has been found, pair it.

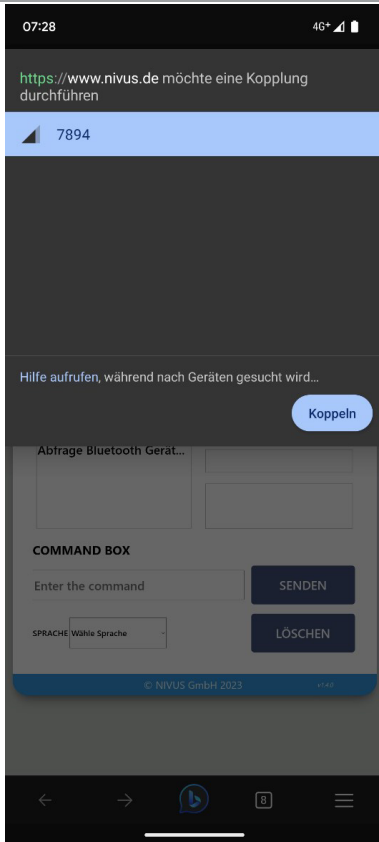

The connection to the sensor is established (the dark blue buttons turn light blue) and the web-based user interface changes from "Start" to "Trace".

Further operation is carried out according to the chapters "Start Page of the web-based User Interface", "Trace Page" and "Parameters Page".

Connecting PC/Laptop via Bluetooth

Important Notice

Ensure that the sensor is powered prior to making a connection to the NIVUS Ri-Series radar sensor user interface.

Enter <https://www.nivus.de/ri-app> into your browser (see below) and press enter to search for the page. You can save this to your list of **bookmarks** so that you can easily connect to a sensor at any time.

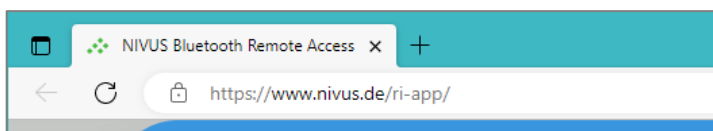

You will be directed to the NIVUS Ri-Series radar sensor Bluetooth start page from where a connection to the sensor can be made.

Open the application and connect your sensor according to the following chapter "Connection NIVUS Ri-Series Radar Sensor".

Further operation is then carried out according to the chapters "Start Page of the web-based User Interface", "Trace Page" and "Parameters Page".

Connection NIVUS Ri-Series Radar Sensor

Firstly, select the  button to begin scanning for your intelligent sensor.

A window will appear displaying the available intelligent NIVUS Ri-Series radar sensors to connect to.

Until the device name is changed, by default each sensor is identified by the last 4 digits of its unique serial number.

For example, if the sensor you wish to connect to has a serial number of 7894, the Bluetooth pairing window will look like depicted below:

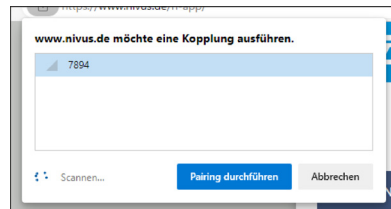
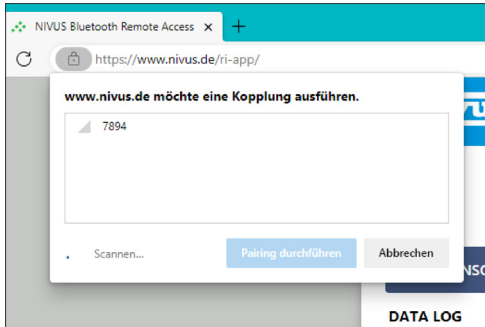

Select the sensor you wish to connect to, and then press the "Execute Pairing" button which will now be highlighted in blue.

When connected, all the selectable buttons on the software will change from dark blue to light blue signifying a connection has been made. The command box will also display the message "Connected" and run through a quick diagnostic to ensure all is well with the sensor (which takes approx. 4 seconds).

When complete, the web-based user interface will automatically change to the Trace screen to allow you to view the echo, level, distance and status information from the NIVUS Ri-Series radar sensor.

Important Notice

If this is not the first time connecting to a sensor, a Bluetooth password may have been set.

When "Execute Pairing" is selected, a prompt may appear to enter a password to allow access to the NIVUS Ri-Series radar sensor via the Bluetooth connection.

The standard password of the sensor is "000000". The HTML interface automatically enters this password in the background. If the password is not changed, no entry is necessary.

Start Page of the web-based User Interface

The start page allows the connection/disconnection to an intelligent NIVUS Ri-Series radar sensor, the ability to query and change parameters along with providing live information on the current readings obtained from the sensor connected.

Language

The web-based user interface is in German. To display the contents in English, select "English" under "SPRACHE".

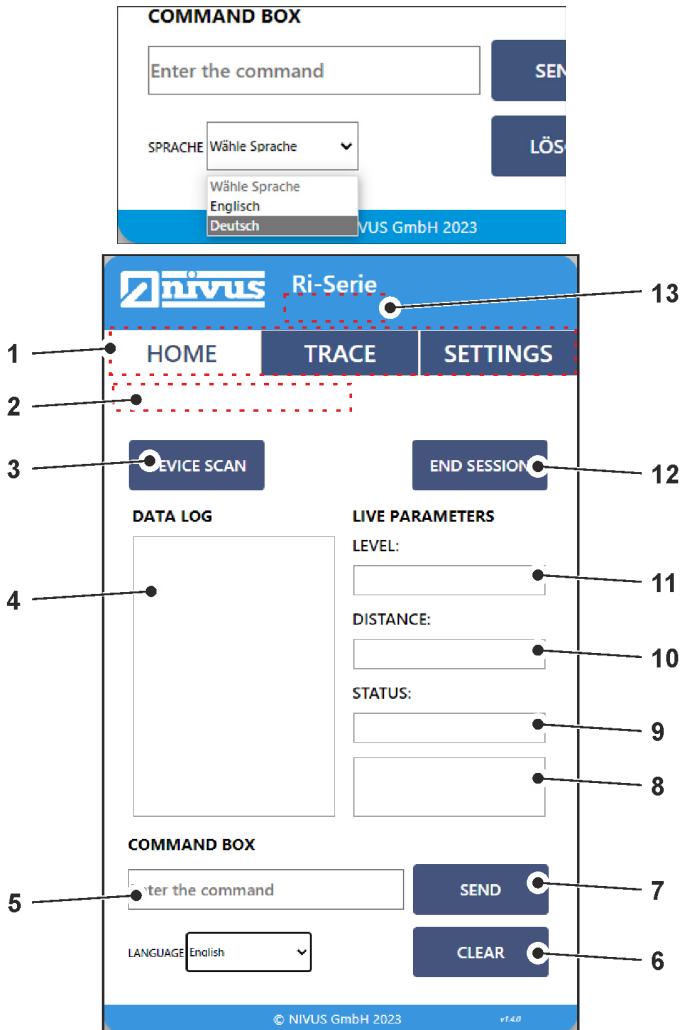

- 1. Web Page Selector:** Displays the current NIVUS Ri-Series radar sensor page you are viewing highlighted by a white background.

2. **Update Information:** When a connection is made, update information for the echo trace will appear in this section here.
3. **Device Scan (Search Sensor):** Click this to scan and pair to NIVUS Ri-Series radar sensors.
Once selected, a window will open for you to select the sensor you wish to pair via Bluetooth and connect to.
When connected to a sensor, the buttons on the web-based user interface will change from dark blue to light blue, signifying a connection has been made successfully.
4. **Data Log:** This window shows a summary of the communication between the connected sensor and the web-based user interface via Bluetooth. It also shows all parameter queries and changes that are made.
5. **Command Box:** The command box can be used to query and change value on parameters in the sensor connected.
 - a. To query a parameter, you would type in **/Pxxx** (where 'xxx' is the parameter number) and then press Send. The current value will appear in the Data Log.
Example: If you wish to view what is set in P105 you would type the following: **/P105** and press Send. The information requested will then appear in the data log.
 - b. To change a parameter, you would type in **/Pxxx:n** (where 'xxx' is the parameter number and 'n' is the value you wish to change that parameter to).
Example: If you wish to change what is set in P105 you would type the following: **/P105:7** and press Send. The new value will then appear in the data log.
6. **Clear:** When selected this will clear all information shown in the Data Log window.
7. **Send:** When selected this will send any command that has been requested by the user to the sensor connected.
8. **Live Parameter set:** Current Volume measurement (if setup to measure volume), Temperature and current output (in milliamps) are shown below the live status.

- 9 **Live Status:** This displays the status of the sensor connected.
- 10 **Live Distance Measurement:** This displays the current **Distance** measurement being obtained from the sensor connected.
- 11 **Live Level Measurement:** This displays the current **Level** measurement being obtained from the sensor connected.
- 12 **End Session:** When this is selected, you will terminate the connection between the web-based user interface and the sensor you were connected to.
To make a new connection, select Device Scan.
- 13 **Device Name:** If the sensor connected has been given a unique device name, it will appear here once a successful connection is made.

Trace Page

The "Trace" page provides real time echo trace readings, and status information on the current readings obtained from the sensor connected.

You can also turn on/off the real time echo trace information on this page. This is the page that is displayed as soon as a confirmed connection has been made to a NIVUS Ri-Series radar sensor.

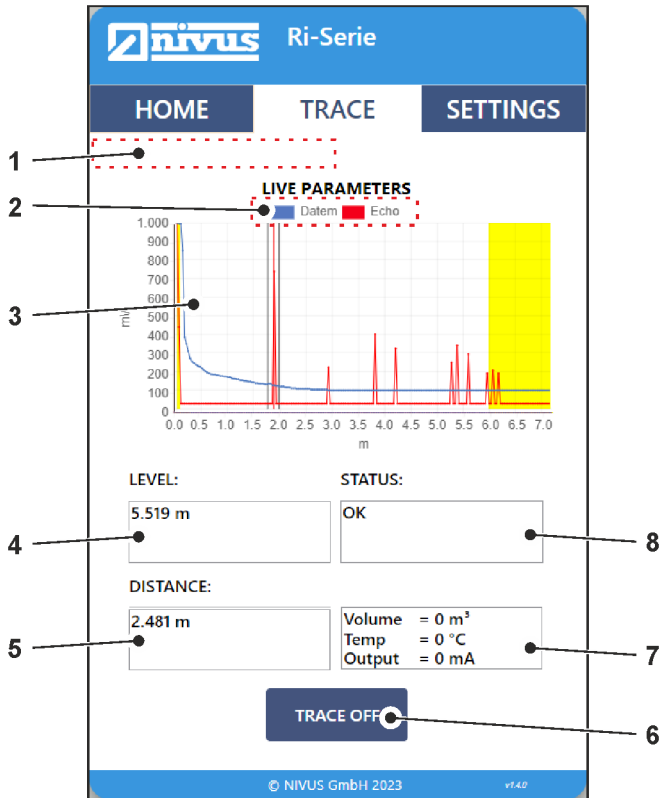

1. **Update Information:** When the echoes are being requested, update information for the echo and blanking trace will appear in this section here.
2. **Toggle DATEM and ECHO:** Option to view/hide DATEM and ECHO respectively by clicking on it.
3. **Diagnostics/Trace Area (Current Readings):** The graph area is used to display real time diagnostic echo trace information from the sensor connected.
 The X axis represents the distance in measurement units (P104) defined by the sensor.
 The Y axis represents the signal strength in mV, on the status display this is represented as a percentage (0 mV = 0 % and 1,000 mV = 100 %).

Refer sections of [Raw Echo](#), [Gate and Measurement line](#), and [DATEM \(Digital Adaptive Tracking of Echo Movement\)](#) for detailed explanation on the echo trace data.

4. **Live Level Measurement:** This displays the current **Level** measurement being obtained from the sensor connected.
5. **Live Distance Measurement:** This displays the current **Distance** measurement being obtained from the sensor connected.
6. **Trace On/Off:** Turns ON/OFF the echo request sent to the connected sensor.
7. **Live Parameter set:** Current Volume measurement (if setup to measure volume), Temperature and current output (in milliamps) are shown below the live status.
8. **Live Status:** This displays the status of the sensor connected.

Parameters Page

The parameters page provides the user with options to view/update readily available Bluetooth and RADAR parameters. Once connected to a NIVUS Ri-Series radar sensor, selecting the parameters page for the first time would do an initial query of all the RADAR parameters once.

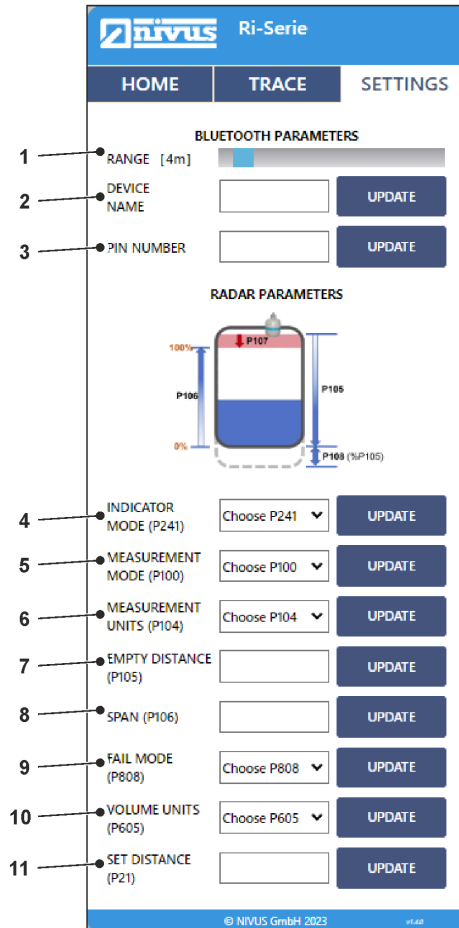

1. **Range:** Indicates the current Bluetooth range in metres. Also, allows the user to set the range between 4 and 40 m using the slider.

This could be used to prevent unauthorised access to the sensor from outside the facility where it has been installed.

Note: The range is installation dependent and will be reduced by solid obstructions. A closed metal tank will greatly reduce the Bluetooth range.

- 2. Device Name:** Displays the name of the connected sensor. Also, allows the user to set the name to any 4-digit alphanumeric character.
- 3. Pin Number:** Sets the password for the Bluetooth device.

Important Notice

If the Bluetooth name of the sensor was changed, the user needs to re-boot the unit and refresh the web-based user interface to see the changes.

The user can enter the new password, which could have a maximum of up to 6 numeric characters.

- 4. Indicator Mode (P241):** Gets/sets the indicator mode for the sensor.
See [P241 Indicator Mode](#) for further information.

Important Notice



The user would see a warning message if the unit was running in any of the installation modes.

This message appears only in the Parameters page. It serves as a reminder to switch to the unit to the "Self_Diagnostic Mode" (P241:7) after installation.

- 5. Measurement Mode (P100):** Gets/sets the operation mode for the sensor.
See [P100 Mode of Operation](#) for further information.
- 6. Measurement Units (P104):** Gets/sets the unit of measurement.
Refer [P104 Measurement Units](#) for further details.
- 7. Empty Distance (P105):** Gets/sets the zero point.
Refer [P105 Empty Level](#) for further details.
- 8. Span (P106):** Gets/sets the measurement span.
Refer [P106 Span](#) for further information.

9. **Fail Mode (P808):** Gets/sets the mA output in the event of the unit going into fail-safe mode.
Refer [P808 Fail Mode](#) for detailed explanation.
10. **Volume Units (P605):** Gets/sets the unit used for the volume calculations.
Refer [P605 Volume Units](#) for detailed explanation.
11. **Set Distance (P21):** Set the user defined echo to be selected as the correct target.
Refer [P021 Set Dist.](#) for detailed information.

You will notice upon entering the Parameters page and when changing a value in the page, the buttons will change colour. The table below shows the different colours and what they mean:

COLOUR	DESCRIPTION
	An intelligent NIVUS Ri-Series radar sensor is not currently connected.
	The web-based user interface is doing an initial query of the parameters, or a new value has been submitted for change by the user.
	An intelligent NIVUS Ri-Series radar sensor is currently connected. The change requested by the user has been accepted and stored into the connected sensor.

NIVUS Ri-Series Software

The free NIVUS Ri-Series software is a powerful tool that is used to aid you in obtaining the most from your intelligent sensor. It can be downloaded for free from the NIVUS website: <http://www.nivus.de/DD-ri-sw-00>

The NIVUS Ri-Series software can be used to store all the parameters set in your sensor of your application. These can be saved to a PC and stored for future reference, or to clone a sensor.

All parameters can be downloaded, viewed and if necessary, changed on an intelligent sensor via your laptop to suit your application.

The software can also be used to record and view Echo Profiles from your applications. These can be saved for your records or sent via e-mail back to NIVUS GmbH for our engineers to analyse.

The software can also be used to re-program your NIVUS Ri-Series radar sensor to the latest version of firmware, with any enhancements that it may contain.

Please consult NIVUS GmbH for further information on re-programming your sensor if it is required.

Software Installation

When setting up your HART modem for the first use, you will need to install the necessary drivers for it to operate correctly with your OS. These drivers can be installed from the NIVUS Ri-Series software installation package. Run the software .exe file from our website to install the software correctly.

Important Notice

For optimum installation insert your HART modem to your PC whilst installing NIVUS Ri-Series software, where your PC should then assign the modem to a Com Port. Or if you have an internet connection, upon inserting the USB of the HART modem for the first time, Windows updates should install this onto your computer for you. Once the driver's installation has completed, remove the HART modem from your machine. Your modem is ready to be used when a connection to NIVUS Ri-Series software is required.

NIVUS Ri-Series HART Connection to NIVUS HART-Modem (ZUB0 HART BOX 04)

Important Notice

The HART-Modem ZUB0 HART BOX 04 has no ATEX approval! Programming via the HART modem may therefore **only** be carried out **outside** the Ex zone, whereby both sensor and modem must be in the non-Ex area!

If you use the NIVUS HART modem ZUB0 HART BOX 04 for programming, the Ri-series sensor must not be connected to any other power source. The NIVUS modem supplies the sensor self-sufficiently via the USB interface.

When you connect the NIVUS HART modem to your PC/laptop/tablet via the USB interface for the first time, the driver installs automatically. If this is not the case, then you can download the driver here free of charge:

<http://www.ftdichip.com/Drivers/VCP.htm>

SPECIFICATIONS

Input voltage (via USB)	~ 5 V DC
Output voltage (loaded)	15 V DC
Output current max.	65 mA
Connectable Sensors	1

Wiring diagram Ri-Series sensor / ZUB0 HART BOX 04:

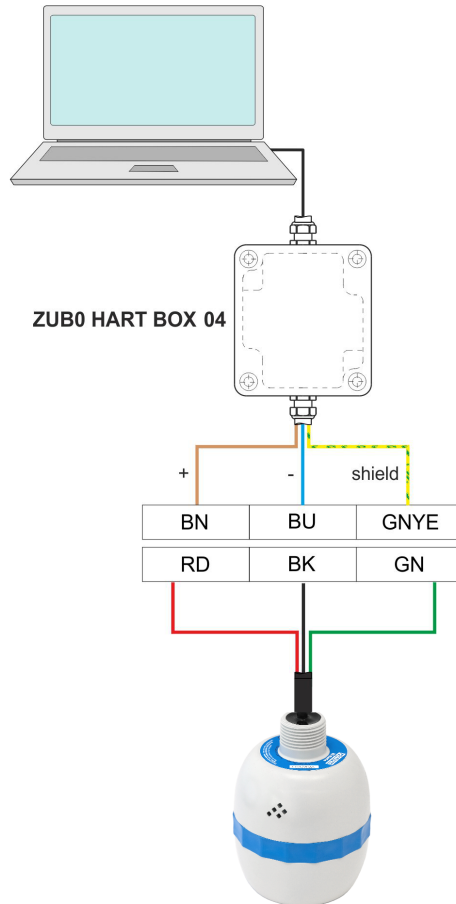

NIVUS Ri-Series HART Connection to Customer HART-Modem

Important Notice

Make sure that the HART modem you are using is connected **between** the transmitter/data logger and the Ex barrier.

See also illustration "Hazardous Area Installation" on page 20.

To connect to NIVUS Ri-Series software, a HART modem is required to allow communication between the software and the sensor. When connecting to the software using the HART modem, power to the sensor can be obtained from a 12-28 V DC source.

Important Notice

Ensure that power to the sensor is switched 'OFF' before removing cables and any connection is made.

To allow the NIVUS Ri-Series radar sensor to operate correctly, please ensure that the transducer is wired as shown in the picture below:

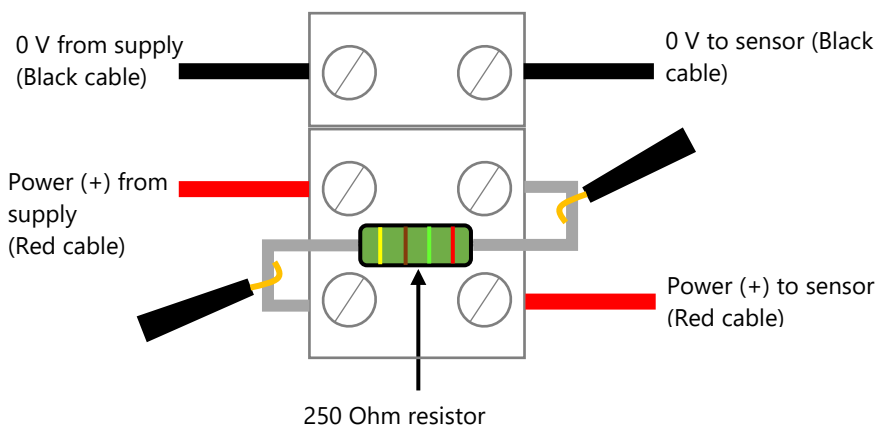

To enable the sensor to work correctly, the power (red) cables from the supply and to the sensor must be wired in series with the 250 Ohm resistor (as seen in the above picture).

Once the sensor is connected to the HART modem, insert the USB into the PC/laptop ready for use. You can now use NIVUS Ri-Series software to make any change of parameters to the sensor to suit your application.

NIVUS Opening the Ri-Series Software

Important Notice

To install the software, you need administrator rights for the desired storage location (network or local computer).

If necessary, contact your IT department.

Once the NIVUS Ri-Series software is installed and a shortcut is created on the PC/laptop/tablet, you can start the software by double-clicking on the NIVUS Ri-Series software icon of the shortcut. By default, the icon is set to a picture of the Ri-Series sensor.



After double-clicking, a window appears asking you to enter a password (as shown in the figure below).

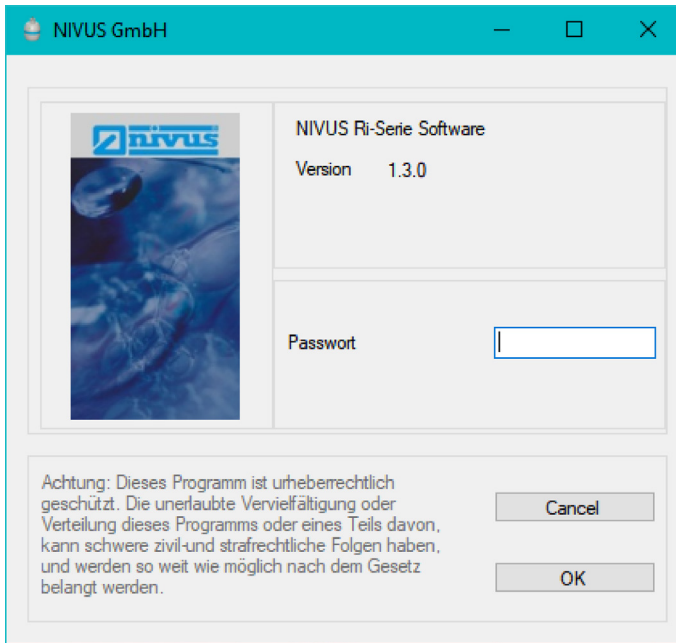

The password to access the NIVUS Ri-Series software is **1997**.
Once typed in press enter and the software will open and be ready for use.

NIVUS Ri-Series Software Start Screen

Menu Bar

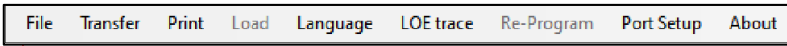

Shortcut Icons

Main Screen Selection Tabs

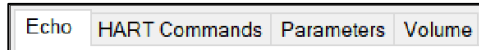

Main Screen

Toggle/update changed Parameter Display

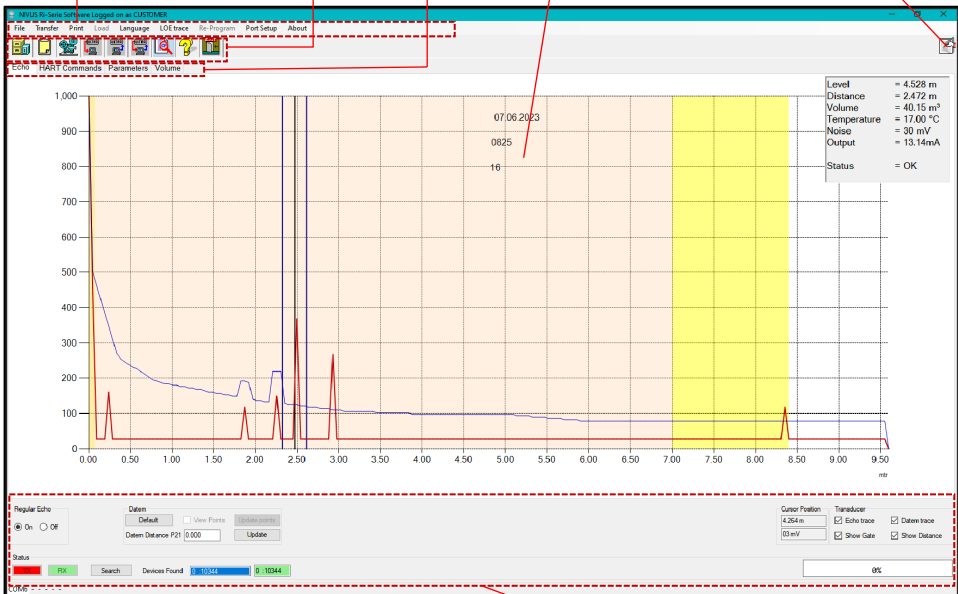

Common Controls

Menu Bar

File

Selecting this drop-down menu will give you the option of opening a previously stored parameter file, an echo file or saving parameters to file.

Transfer

The **Transfer** menu enables you to do the following:

Get parameters from unit: Once uploaded to the software from the sensor, you will be asked to save the parameters as file name and location on your PC of your choosing.

Send parameters to the unit: Send all parameters currently loaded on the sensor to Ri-Series software.

Single Parameter programming: This is where you can view and/or change a parameter one at a time.

Print Parameters and Traces

The **Print** menu enables you to do the following:

Save trace as .jpg: A screenshot is saved of the echo currently displayed to a file name and location on your PC and can then be copied into a document.

Print trace: Prints a copy of the trace currently viewed to your printer.

Print parameters: Allows you to print a complete list of all the parameters that are accessible in the sensor.

Print changed parameters: Allows you to print a list of only the parameters that have been modified from their default values in the sensor.

Load

The "Load" option will be greyed out as this requires service access.

Language

Here you can set the software language. Currently, German and English are available.

LOE Trace

This is to enable either a LOE trace or an alarm trace.

Re-Program

The "Re-Program" option will be greyed out as this requires service access; this will allow you to re-program the sensor with up-to-date firmware. Please consult NIVUS GmbH for assistance in carrying out this operation.



ComPort Settings



The **Port Setup** menu enables you to open up the ComPort Settings window, enabling you to select the comport that the sensor is connected to.





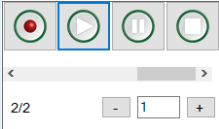
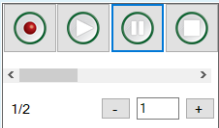

Software Info / About

This displays information about the NIVUS Ri-Series software you are using, e.g. the version.

Shortcut Icons

NAME	SYMBOL	DESCRIPTION
Load Parameter File		Allows you to search for any parameter file that you wish to open, view, and examine. Parameter files are saved in a .xml format.
Copy to clipboard		Selecting this icon will paste the current viewed echo profile onto your clipboard. From there it can be pasted into a document such as word for recording, viewing or reporting.

NAME	SYMBOL	DESCRIPTION
<p data-bbox="132 660 273 715">Record Echo Profiles</p>		<p data-bbox="441 197 1005 319">When selected, a window will appear with 4 buttons to select from. Record, play, pause and stop. The button that has been selected will be highlighted by a blue background.</p>  <p data-bbox="683 367 956 392">Record (Recording a Trace)</p>
		<p data-bbox="441 469 1012 619">When recording an echo trace, you will first be prompted to save the echo recording on to your PC. When done, the record button and status bar will turn red, indicating that recording is underway. When finished, select the record button again to stop.</p>  <p data-bbox="683 667 925 692">Play (Replaying a Trace)</p>
		<p data-bbox="441 772 1005 890">To replay a saved echo trace, select the "Play" button and choose the relevant echo file (.hir) to replay. The play button will be highlighted by a blue background to indicate that an echo is being replayed.</p>  <p data-bbox="683 941 938 967">Pause (Playback Controls)</p> <p data-bbox="441 1043 994 1136">You can also pause and move the slider to a specific position of the total trace recordings (ideal for long recordings).</p> <p data-bbox="441 1149 833 1174">Press Stop to end the Record/Replay.</p>

NAME	SYMBOL	DESCRIPTION
Get Parameters from Sensor		This enables you to download all parameters that are currently in the sensor that is connected to the NIVUS Ri-Series software. You will be prompted to save the parameters when the download is complete.
Send Parameters to Sensor		This allows you to send all parameters at once in the NIVUS Ri-Series software to the sensor that is connected.
Single Programming		This enables you to program one parameter at a time. Press the single programming icon and, when the Interactive Programming display window appears, press the connector icon, this will connect your PC to the sensor. Key in the parameter number required and press the "Read" key. Change the value to the required amount and press "Save", the change is then accepted. Note: Pressing the "Datum Reset" and "Parameter Reset" icons will reset them to their original values. "Factory Default" restores the factory setting of your unit.
Status Display On/Off		Selecting this icon enables a small list of information (top right on the display) about the performance of the unit. These include level, distance, volume, temperature, noise, output and status.
System Information		This enables you to view the current software/hardware version and serial number of the NIVUS Ri-Series sensor connected.
Exit		Selecting this will exit your current session from the NIVUS Ri-Series software. Note: Please ensure any unsaved parameters are uploaded to the NIVUS Ri-Series sensor prior to selecting this option.

Toggle/Update changed Parameter List

When you have uploaded the parameters from the connected NIVUS Ri-Series sensor (or from your laptop), a list of changed parameters will appear in the right-hand side of your screen.

Clicking the "Toggle/Update changed Parameter List" icon  will alternately show all parameters, (with the changed parameters highlighted in yellow), show only the changed parameters, and then hide the table from view.

Main Screen Selection Tabs

Echo

This provides a graph and controls for viewing diagnostic echo traces.

HART Commands

This provides access to generic common parameters that are common to all HART compatible devices.

Parameters

The NIVUS Ri-Series sensor's parameters can be viewed in a table format, and in relational groups. Hovering your cursor over the parameter value boxes, will allow you to view the information that can be selected for that specific parameter.

For further information on the parameters available in each section and their options, please refer to [Chapter 5 Parameter Listing and Description](#).

Volume

The volume is only output if the measuring mode (P100) is set to 4 volumes (if other parameters are set, the level, distance, etc. are output). This allows simple parameter setup of a vessel shape and its dimensions, or alternatively the setup of a pre-determined 16-point level/volume breakpoint table.

Main Screen

The main screen is used to display real time diagnostic echo trace information from the NIVUS Ri-Series sensor connected or replay recorded echo traces previously saved.

Echo traces

To request an echo trace from the NIVUS Ri-Series sensor, select the "Regular Echo 'On'" button, this will turn on and an echo will then be presented on the main screen.

The X axis represents the **distance** in **measurement units (P104)** defined by the NIVUS Ri-Series sensor. The Y axis represents the **signal strength** in mV, on the status display this is represented as a percentage (0 mV = 0 % and 1,000 mV = 100 %). An example of an echo trace is shown below:

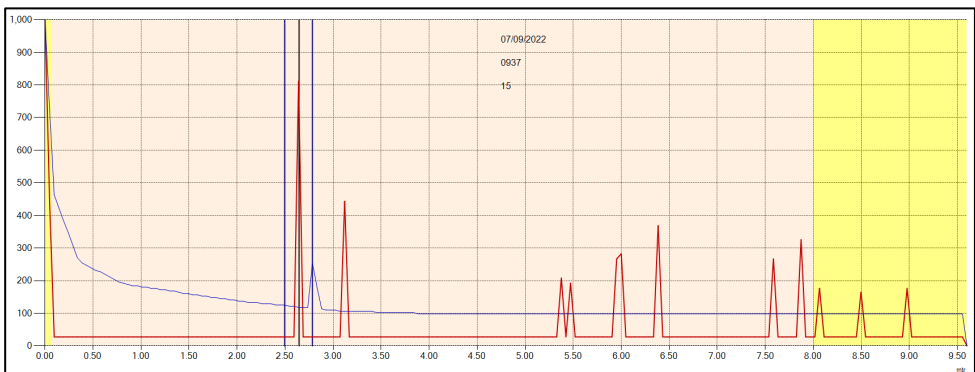

Raw Echo

The Raw echo is shown in red. It shows signals (echoes) reflected from objects as peaks in the trace.

The higher the peak of the echo, the stronger the echo is. The far-left portion of the raw echo trace is known as the ringdown. The ringdown region is the reason for the near blanking dead band. As a target moves further away from the transducer, the signal strength of the returned echo will reduce.

Gate and Measurement line

The distance line shows which echo is being selected for the measurement. The vertical blue lines remain fixed at either side of the distance line, and act as a stability mechanism to filter out any momentary echoes from passing machinery/stirrers etc.

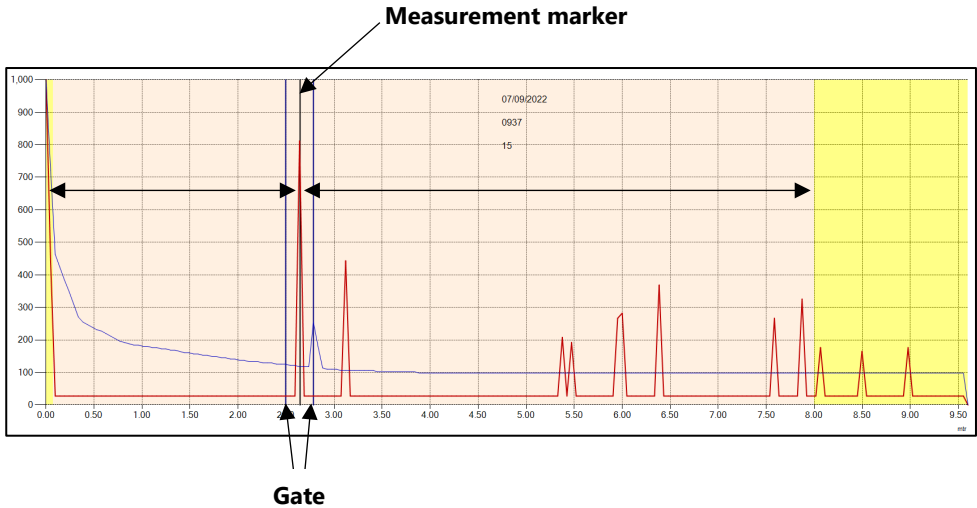

DATEM (Digital Adaptive Tracking of Echo Movement)

The (blue) DATEM trace (line) acts as a threshold which defines if echoes are considered as candidates for measurement. Any echo whose peak is below the DATEM line, will not be considered for measurement. In effect the transducer will not "see" it.

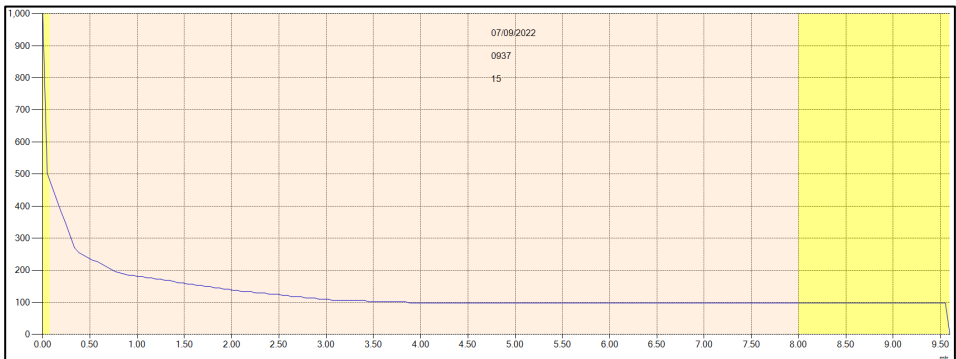

By default, the DATEM in NIVUS Ri-Series sensors is ACTIVE which means it will grow to cover (mask out) any fixed obstructions in front of the current measurement echo.

Looking at the trace below, the only echo which can be "seen" by the echo selection algorithm is the current selected echo at 2.6 metres (value shown in the example).

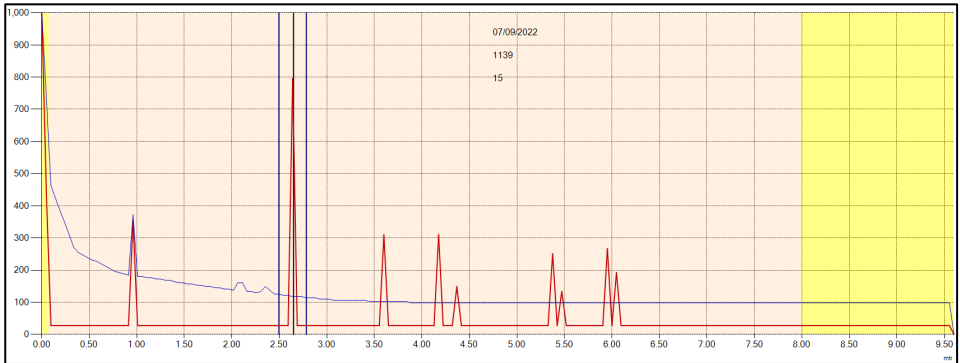

Zooming

You can zoom into an echo trace by clicking and dragging a window from Top Left to Bottom Right across the area you want to zoom into.

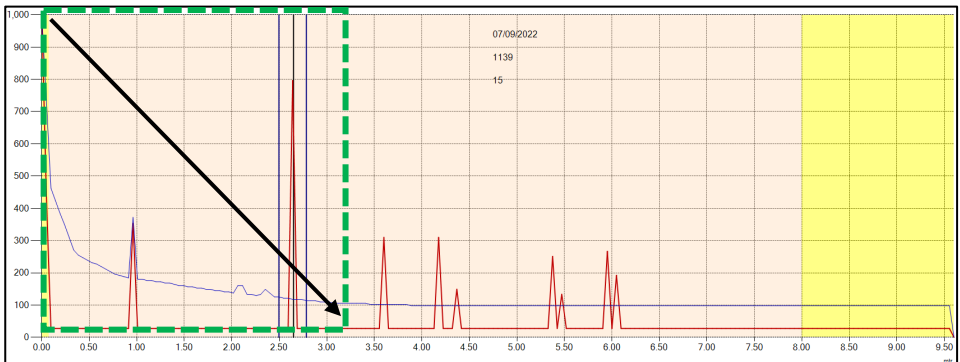

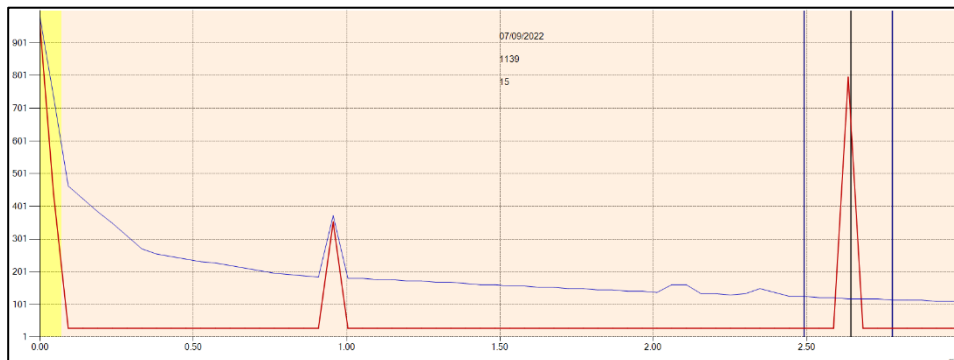

To zoom out, simply draw a box from the bottom right to top left and the echo trace will resume its normal shape.

Important Information

If you are connecting to multiple devices that are to be placed onto a HART network, the Poll address of each sensor will need to be changed from the default value of 0. Please use HART command 6 (Set polling address) to change the address of each sensor.

Common Parameters

This section of the screen is visible at all times and has controls for scanning and connecting to the intelligent sensors, obtaining echoes, manipulating DATEM, progress bar indication and cursor positioning on the echo screen.

Status

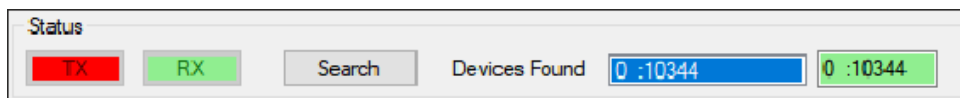

From the left of the status section, the transmit (TX) and receive data (RX) from the NIVUS Ri-Series sensor are shown, when it is communicating with the NIVUS Ri-Series software. They will flash red/green when communication is being made.

After using the Setup menu option to detect the correct comport, you can look to make a connection the connected NIVUS Ri-Series sensor.

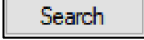
Click on the  button to begin a scan of any connected HART devices. The poll address and serial number any device(s) found will appear in the white box "**Devices Found**".

Click on the white box of the serial number of the sensor you are looking to communicate with. The white box will change to blue, and the adjacent box will be highlighted as green with the poll address and serial number of the connected sensor (as shown in the example below).

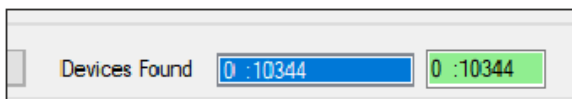

Once a connection is made successfully, the buttons in the "Common Controls" section will become active, except for "View DATEM Points" and "Update Points" as this is a service level access feature.

Trace

To request echo traces from the intelligent sensor, change "Regular Echo" from OFF:

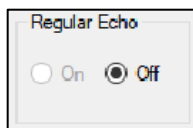

to ON:

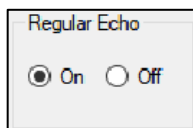

When "Regular Echo" is turned on, the echo status field will highlight red indicating a trace is being obtained and displayed. When obtaining a trace for the first time it will take approx. 7 seconds to retrieve the information. After this the trace will continue to display live information from the sensor every 2 seconds.

*DATEM***Important Information**

This feature is only available when in service mode. If necessary, contact the NIVUS GmbH for further assistance.

The DATEM line can be adjusted manually by selecting the "View Points" box in the DATEM area. When selected a purple line will appear on the echo trace graph with a number of moveable points, as shown in the example below:

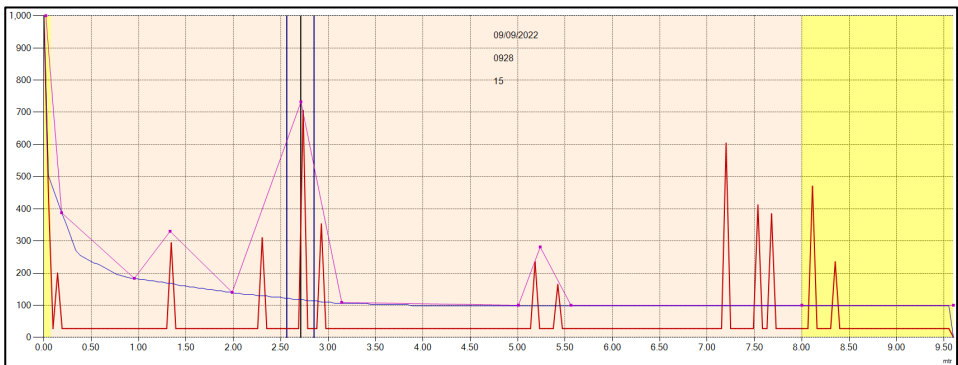

The points can be clicked on and dragged in order to manipulate the DATEM line to cover any unwanted echoes you want to hide from the echo selection algorithm. Once the line is in its final position, click the "Update" button in the DATEM area and the new values will be transferred to the real time DATEM line, and the echo will change like the example below:

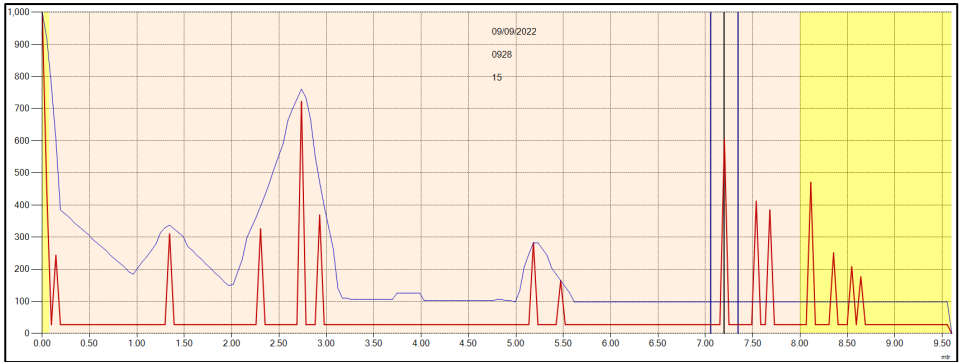

Default

To undo the manipulation of the DATEM points, select the button in the DATEM area and the DATEM line will resume its default value:

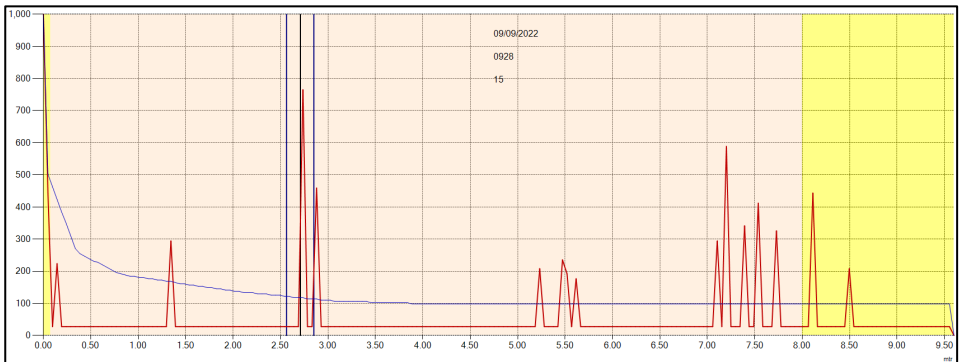

P21 DATEM Distance

Datem Distance P21	<input type="text" value="0.000"/>	<input type="button" value="Update"/>
--------------------	------------------------------------	---------------------------------------

To display echo traces from the intelligent sensor, change "Regular Echo" from OFF to ON:

This parameter allows you to determine which echo is to be used for measurement purposes. On start-up, if the sensor is showing an incorrect measurement value, then simply enter the distance from the transducer face to the required material level and, if an echo is present at this point, the gate will establish itself around the chosen echo. DATEM will update in front of the gate and reference out any other unwanted echoes.

It should be noted that DATEM will reset to default values whilst performing this function, and reform itself once it has selected an echo.

Enter distance from the face of transducer to the target in **Measurement Units (P104)**.

Datem Distance P21	<input type="text" value="0.000"/>
--------------------	------------------------------------

Enter the value of the distance measurement **(in Measurement Units (P104))** into the white box.

<input type="button" value="Update"/>

Press the "Update" button, to lock on to the selected echo. The "Update" button will be highlighted as green to signify the change is taking place and when complete it will return to grey. Press "On" to obtain a new echo trace and the value in the white box will return to 0.

Progress Bar

The progress bar color the changes to indicate the different actions that are being performed.

Blue indicates that the raw echo is being obtained and updated when it reaches 100 %.

Purple indicates that the DATEM line is being obtained and updated when it reaches 100 %.

Red indicates that the echo trace information is being recorded and the file updated when it reaches 100 %.

Cursor Position

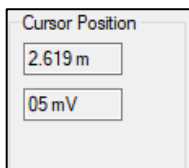

A screenshot of a software dialog box titled "Cursor Position". It contains two input fields: the top one displays "2.619 m" and the bottom one displays "05 mV".

When hovering the mouse pointer on the echo trace graph, the pointer position will be updated in the **Measurement Units (P104)** and "mV" in the cursor position value boxes.

Sensor

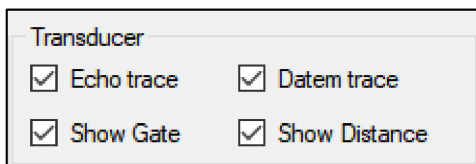

A screenshot of a software dialog box titled "Sensor". It has a "Transducer" section with four checked checkboxes: "Echo trace", "Datem trace", "Show Gate", and "Show Distance".

Echo Trace

This option displays the raw echo when selected. If unselected the raw echo will be hidden from view on the echo trace graph.

Show Gate

This option displays the measurement window when selected. If unselected the measurement window will be hidden from view on the echo trace graph.

DATEM Trace

This option displays the DATEM trace when selected. If unselected DATEM will be hidden from view on the echo trace graph.

Show Distance

This option displays the line of the measurement marker when selected. If unselected the measurement marker will be hidden from view on the echo trace graph.

Quick start setup

This section explains how to undertake functions of your intelligent sensor to quickly setup the sensor for a basic level measurement. For specific parameters see [Chapter 5 Parameter Listing and Description](#).

Setting up Your Application

Empty Distance

Empty Distance (P105) is the distance from the face of the transducer to the material at the bottom of the vessel.

Important Information

If using the sensor version with front thread, the empty distance measured from the face of the thread to the material being measured requires an offset of 38 mm (1.5"). To perform this offset, use P851 (measurement offset) and set the value of this parameter to -38 mm (-1.5").

Span

Span (P106) is the distance from the empty level (0 % full) to span (100 % full).

Near and Far Blanking

Near Blanking (P107) is the distance from the sensor face that the intelligent sensor will not record a level nearer than. A typical reason to increase this from the default value would be if you wish to ignore close in obstructions.

Far blanking (P108) is the distance (as a percentage of empty level) beyond the empty level that the intelligent sensor will read, the default is plus 20 % of empty level. If you wish to monitor further than the **empty level**, then increase this figure, so that the **empty level** plus the **far blanking** figure (as % of empty level) is greater than the surface being measured, within the capability of the transducer being used.

Using the 4-20 mA Output

The mA output is used to remotely monitor what the sensor is measuring. This can be displayed remotely, integrated into a PLC, or used to generate a record using a chart recorder or similar.

By default, the sensor will provide a 4-20 mA output that is proportional to **level**. It can be overwritten as follows:

By default, the 4-20 mA will represent the operational span of the sensor model in use, with empty (0 % full) = 4 mA and full (100 % of the operational span) = 20 mA. However, you may wish to only represent a section of the operational span. For example, the application may have an operational span

of 6 metres, but you may only wish to represent empty level to 5 metres. If so, change **P834 (Value for 4 mA)** to **0**, and **P835 (Value for 20 mA)** to 5.0. If the device connected to the mA output is out of calibration, and cannot be calibrated, then the low and high current levels can be trimmed by altered in the "HART Command" tab **P838 (Low Trim)** and **P839 (High Trim)**. To do this, simply enter the value that ensures that 4 mA or 20 mA respectively are shown on the remote device.

Defining Setting Security/Passcodes

A security code/passcode is used to protect parameter entries and will be required when accessing parameters with certain PC software. You can set a new security code to prevent anyone changing any of your settings within your NIVUS Ri-Series radar sensor.

Important Notice

The passcode is also used for remote access using certain PC Software's or the Bluetooth. So if this is being used, be sure to ensure any additional equipment using this feature is changed accordingly.

The default **passcode** is **1997**, but this may be changed.

Reset to Default Setting

If you need to restore parameters to their original factory settings, then access parameter P930, which is the factory defaults parameter, change the value to 1 and ENTER.

All parameters, except for the mA trims, will be restored to the factory settings (including the DATEM trace).

Checking the Software Revision and Serial Number

If you need to identify the serial number of the unit or the current level of software in your NIVUS Ri-Series sensor, the following parameters can be used. Select parameter **P926** to view the identity of the current software **revision** or **P928** for the **serial number** of the unit.

CHAPTER 5 PARAMETER LISTING AND DESCRIPTION

Application

Operation

P100 Mode of Operation

This parameter sets the mode of operation, when in run mode, and can be set to one of the following:

OPTION	DESCRIPTION
1 = Distance	Display shows the distance from the transducer face to the surface.
2 = Level (Default)	Display shows how full the vessel is.
3 = Space	Display shows how empty a vessel is.
4 = Volume	Display shows volume of material in the vessel.

P102 Material

This parameter should be set to the type of material being monitored.

OPTION	DESCRIPTION
1 = Liquid (Default)	Use for liquids and flat solid materials.
2 = Solid	Solid bulk solids or material that is heaped or solids at an angle.
3 = Closed Tank	Use for closed tanks or domed roofs.

P241 Indicator Mode

This parameter should be set to the type of material being monitored. The below outlines what each indicator mode does:

MODE (P241)	DESCRIPTION	FUNCTION	MA OUT- PUT
0	OFF	Any	Dynamic
1 (As shipped)	Installation – Liquid	Long LED Flash, colors related to Tilt Angle of installation.	20 mA Fixed
2	Installation – Solid Matter	Long LED Flash, colours related to signal strength.	20 mA Fixed
4	Measurement – Liquid	Short LED Flash, colors related to Tilt Angle of material being measured.	Dynamic
5	Measurement Solid Matter	Short LED Flash, colors related to Average signal strength.	Dynamic
7 (Standard)	Self-Diagnostics	Short LED Flash, Indicator follows NAMUR standard for self-monitoring and diagnostics of field devices.	Dynamic

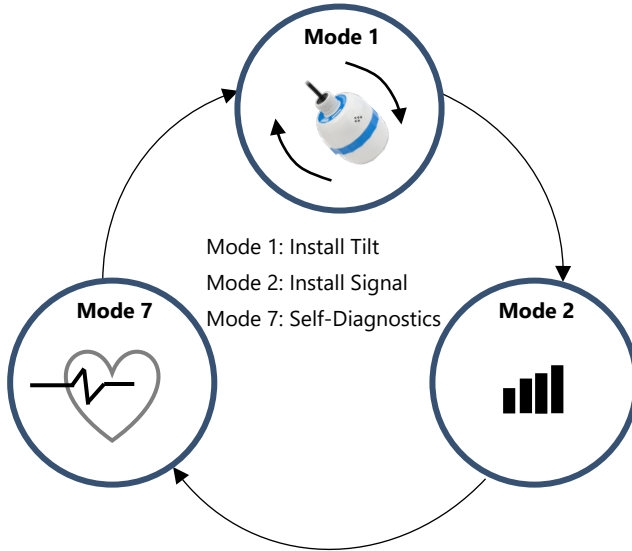

LED Functionality

MODE NUMBER (P241)	LED FUNCTION		
	GREEN	AMBER	RED
0	OFF	OFF	OFF
1	Level with Horizontal plane	Between Pass and Fail	No Level
2	Raw Echo Strength above P242 (Signal Strength Threshold 1)	Raw Echo Strength above P243 (Signal Strength Threshold 2)	Raw Echo Strength below both thresholds
4	Level with Horizontal plane	Between Pass and Fail	No Level
5	Averaged Echo Strength above P242 (Signal Strength Threshold 1)	Averaged Echo Strength above P243 (Signal Strength Threshold 2)	Averaged Echo Strength below both thresholds
7	Refer to table provided below		

Display Mode Self-Diagnostics

DISPLAY MODE SELF-DIAGNOSTICS

CRITICAL (RED)	WARNING (AMBER)	MAINTENANCE (BLUE)	Correct (GREEN)
Echo Loss	Measurement is outside of the gate	Accelerometer not calibrated.	Operating normally
Temperature Limit			
Voltage Limit			
Alarm Flag			
RADAR unresponsive for 5 times			
Ping timeout (45 s)			

Cause Description for critical Error Messages (CRITICAL (RED))

Echo Loss

If the sensor does not receive an echo.

Temperature Limit

If the sensor is outside the temperature specifications.

Voltage Limit

If the voltage at the internal capacitor drops below 5 V.

Alarm Flag

If at least one alarm condition of parameters P951, 952 and 953 is fulfilled.

RADAR unresponsive for 5 times

If the radar sensor does not respond after 5 attempts.

Ping Timeout

If the radar sensor does not receive a signal after 45 seconds after the start.

Distance

P104 Measurement Units

This parameter sets the units you want to use for programming and display.

OPTION	DESCRIPTION
1 = metres	All units of measure are METRES
2 = cm	All units of measure are CENTIMETRES
3 = mm	All units of measure are MILLIMETRES
4 = feet	All units of measure are FEET
5 = inches	All units of measure are INCHES

P105 Empty Level

This parameter is to be set to the maximum distance from the face of the transducer to the empty point, in **P104 Measurement Units**. Note this value affects span as well, so should be set before span.

Default: R8 = 8.00 m (26.24 feet), R20 = 20.00 m (65.61 feet)

P106 Span

This parameter should be set to the maximum distance from the **Empty Level (P105)** to the maximum material level. It is automatically set to be equal to the **Empty Level (P105)** less the **Near Blanking** distance (**P107**)

when you set the empty level. **Default R8 = 7.925 m (26 feet), R20 = 19.925 m (65.37 feet).**

P107 Near Blanking

This parameter is the distance from the face of the sensor that is not measurable and is pre-set to the minimum value dependant on the version of the sensor being used. It should not be set to less than this figure but can be increased.

NIVUS RI-SERIES RADAR SENSOR TYPE	NEAR BLANKING DISTANCE
R8 (up to 8 m)	Default Blanking Distance = 0.075 m (0.24 feet)
R20 (up to 20 m)	Default Blanking Distance = 0.07 m (0.24 feet)

P108 Far Blanking

This is the distance (as a **percentage** of empty level) beyond the empty point that the unit will be able to measure.

The **default** is pre-set to **10 %** of the empty level.

If the surface being monitored can extend beyond the **Empty Level (P105)** then the far blanking distance can be increased to a maximum of 100 % of empty level.

This parameter is always entered as a % of empty level.

Data Logs

The data log parameters contain the following information:

Temperature

The following parameters give information on temperature conditions seen by the **Temperature source (P852)** in °C. These parameters are read only and cannot be changed. However, if P852 is changed they will be reset.

P580 Minimum Temperature

This parameter displays the minimum temperature recorded.

P581 Minimum Temperature Date

This parameter displays the date when the minimum temperature was recorded.

P582 Minimum Temperature Time

This parameter displays the time when the minimum temperature was recorded.

P583 Maximum Temperature

This parameter displays the maximum temperature recorded.

P584 Maximum Temperature Date

This parameter displays the date when the maximum temperature was recorded.

P585 Maximum Temperature Time

This parameter displays the time when the maximum temperature was recorded.

P586 Current Temperature

This parameter displays the current temperature.

Transducer Power Information

The following parameters provide information on when the intelligent Sensor was last powered down and how long it had run for.

P940 Number of Starts

This parameter displays the number of times that the unit has been powered since leaving the factory.

P941 Last Power Off Date

This parameter displays the last date on which the power was removed from the unit.

P942 Last Power Off Time

This parameter displays the last time on which the power was removed from the unit.

P943 Last Run Time (minutes)

This parameter displays how long the unit had been running, in minutes, prior to the last power down.

P944 Last Run Time (hours)

This parameter displays how long the unit had been running, in hours, prior to the last power down.

mA Output

P834 Value for 4 mA Low

This parameter sets the level, distance, or space, at which the low mA output will occur (4 mA).

Default = **0.000 m**

P835 Value for 20 mA High

This parameter sets the level, distance, or space, at which the low mA output will occur (20 mA).

Default = **8.000 m (R8), 20.000 m (R20)**

P838 Low Trim 4 mA

If the sensor you are connected to is not calibrated, and not showing the correct low value (4 mA reading), then you can trim it using this parameter, by typing in the offset directly.

P839 Low Trim 20 mA

If the sensor you are connected to is not calibrated, and not showing the correct high value (20 mA reading), then you can trim it using this parameter, by typing in the offset directly.

Important Notice

It is advised to trim the intelligent sensor for 4-20 mA using the software. This allows you to force a mA output to better trim the sensor.

mA Failsafe

P808 Fail Mode

This parameter determines what happens to the mA output in the event of the unit going into fail-safe mode:

OPTION	DESCRIPTION
1 = Hold (Default)	The sensor will Hold its last known value
2 = High	The sensor shows the Maximum (20 mA)
3 = Low	The sensor shows the Minimum (4 mA)
4 = 22 mA	The sensor outputs 22 mA
5 = 3.8 mA	The sensor outputs 3.8 mA

P809 Fail Time

In the event of a failsafe condition the failsafe timer determines the time before a failsafe mode (**P808**) is activated.

Standard = **2 min.**

Compensation

P851 Measurement Offset

The value of this parameter is added to the measured distance, in **Measurement Units (P104)**.

This offset will be added to the level, as derived from the intelligent sensor. It will affect everything including the reading on the echo display, and the mA output.

P852 Temperature Source

This parameter determines the source of the temperature measurement. By **default**, it is set to automatic (**Option 1**), which will automatically detect if a temperature measurement is available from the sensor. If for any reason, no temperature input is received, then the **Fixed Temp** value is used, as set by **P854**.

The temperature source can be specifically set as follows:

OPTION	DESCRIPTION
1 = Automatic (Default)	Will automatically select transducer temperature sensor, if available, or fixed temperature (P854) if no temperature sensor found.
2 = Sensor	Always uses temperature reading from the sensor.
3 = Fixed	Always uses fixed temperature as set in P854 .

P854 Fixed Temperature

This parameter sets the temperature, in degrees centigrade to be used if **P852 = 3**. **Default = 20 °C**.

Stability

Damping

Damping is used to damp the measurement value, to enable it to keep up with the process but ignore minor surface fluctuations.

P870 Fill Damping

This parameter determines the maximum rate at which the unit will respond to an increase in level. It should be set slightly higher than the maximum vessel fill rate.

Default = 10.000 metres/minute (32.81 feet/minute)

P871 Empty Damping

This parameter determines the maximum rate at which the unit will respond to a decrease in level. It should be set slightly higher than the maximum vessel empty rate.

Default = 10.000 metres/minute (32.81 feet/minute)

Filters

P881 Fixed Distance

This parameter determines the width of gate to be used in tracking an echo and under normal circumstances will not require changing. It can be increased, however, in the cases where the surface is moving extremely fast (more than 10 m/min) to ensure smooth processing of the changing level.

P884 Peak Percentage

When **P102 = 2 (Solids)**, this parameter can be used to determine the point at which the measurement is taken within the established gate of the selected echo. This is to compensate for any error that maybe caused by "angles of repose" presented by the way the material settles. Please consult NIVUS GmbH for further information and assistance on changing the value of this parameter.

System

Important Notice

Parameters 926, 927 and 928 do not affect how the unit performs, but details contained in them may be required by NIVUS GmbH when making technical enquiries.

System Information

P926 Software Revision

This parameter will display the current software revision.

P927 Hardware Revision

This parameter will display the current hardware revision. It is read only and cannot be changed.

P928 Serial Number

This parameter will display the serial number of the sensor connected.

Standard

P930 Factory Defaults

This parameter resets all parameter values to the original Factory Set values that were installed when the unit was tested before despatch to you.

To **reset** parameters, Set P930 to 1.

Date & Time

The date and time are used, to stamp certain events that are contained in the Data Logs. It is also used in conjunction with the system watchdog that keeps an eye on the times the unit has started.

P931 Date

This parameter displays the **current date**, in the format as set by **P933 (Date Format)** and can be reset if required.

P932 Time

This parameter displays the **current time** and can be reset if required, in the format HH:MM (24-hour format). This is set initially at the factory for UK time.

Password

P921 Enable Code

Enables the passcode (**P922**), which means the passcode must be entered to go into program mode. If **disabled** (set to **0**), then no passcode is required. Pressing ESC and ENTER button simultaneously will then allow entry into the program mode.

P922 Passcode

This is the passcode that must be used to enter program mode. The **default setting** is **1997**, but this can be changed to another value.

Alarm Limits

The intelligent sensor stores an echo trace internally when the alarm condition is triggered. When requesting an echo trace the alarm trace will be displayed on the graph.

The sensor can be set up to capture an echo trace under certain alarm conditions; **Alarm Trace** (activates within the setpoints set in (**P951** and **P952**)) or **LOE Trace**.

P951 Alarm Low

This parameter sets the low value (in **P104 measurement units**) for the alarm setpoint.

P952 Alarm High

This parameter sets the high value (in **P104 measurement units**) for the alarm setpoint.

P953 Alarm Save Trace Mode

This parameter sets the frequency at which a trace is saved to the sensor's internal memory in an alarm condition.

OPTION	DESCRIPTION
0 = Off (Default)	Trace mode off
1 = Once	When an alarm condition is activated, the sensor will save the first trace in its internal memory.
2 = Repeatedly	When an alarm condition is activated, the sensor will save the trace in its internal memory overwriting the previous trace for the new one.

LOE Save Trace

P950 Save DATEM Trace on LOE

When enabled this parameter will ensure that in the event of the unit going into a LOE situation a trace at the time of the LOE occurrence is saved for future reference.

OPTION	DESCRIPTION
0 = Off	Feature is disabled and in the event of LOE echo trace will NOT be saved.
1 = Enable (Single Trace)	In the event of a LOE situation an echo trace WILL be saved and stored for future reference. Once a LOE trace has been saved no further traces will be taken.
2 = Enable Overwrite (Default)	In the event of an LOE event occurring any previous trace will be overwritten and the last LOE trace saved.

DATEM

P020 Set DATEM

This parameter allows DATEM to be reset to its default value. To reset DATEM to its default value set parameter value to 1, the trace will then be set to its default value and then update as normal.

A full list of the options available in P20 are found in the table below:

OPTION	DESCRIPTION
0 = Default blank tank	Performed on an empty tank, so that all unwanted echoes from noise or obstructions are referenced out. The true echo remains visible once material enters the application.
1 = Default to Factory points (Default)	Resets DATEM to default settings.
2 = Default to user points	The DATEM will reset to the points set by the user.
3 = Save DATEM to flash	The current DATEM will be stored to the flash memory of the connected sensor when an alarm condition is activated.

P021 Set Dist.

Allows the user or service personnel to determine which echo is to be displayed. On start-up, if the unit displays an incorrect reading, then simply enter the distance from the sensor to the required level. If an echo is present at this point, the gate will establish itself around the chosen echo. DATEM will update in front of the gate and reference out any other unwanted echoes.

It should be noted that DATEM will reset to default values whilst performing this function, and reform itself once it has selected an echo. Enter distance from **the face of sensor to the target** in units of measurement P104

Values: **Min. 0.000 / Max. 99.00**

P905 Peak Clearance

This parameter is used to set the "**Height**" above which the DATEM trace will "stand-off" from around unwanted echoes such as obstructions. Please consult NIVUS GmbH for further information and assistance on changing the value of this parameter.

P906 Side Clearance

This parameter is used to set the "**Distance**" by which the DATEM trace will "stand-off" from around unwanted echoes such as obstructions. Please consult NIVUS GmbH for further information and assistance on changing the value of this parameter.

P70 DATEM Speed

This parameter is used to the speed in which the DATEM trace will react. Please consult NIVUS GmbH for further information and assistance on changing the value of this parameter.

OPTION	DESCRIPTION
0 = Slow	DATEM updates to changes on an echo at a slow rate.
1 = Medium (Default)	DATEM updates to changes on an echo at a medium rate.
2 = Fast	DATEM updates to changes on an echo at a fast rate.

Volume Conversion



P600 Vessel Shape

This parameter determines which vessel shape is used when utilising "Volume Conversion".

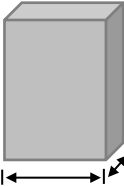
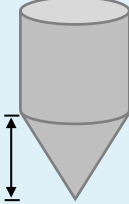
The choices are as shown in the table below, along with the **Dimensions** that are required to be entered (**P601-P603**).

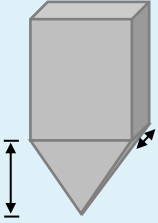
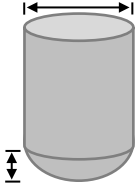
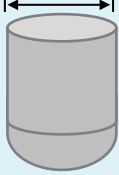
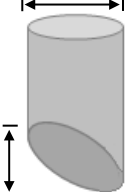
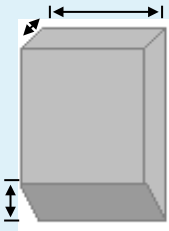
VESSEL SHAPE	P600 VALUE DESCRIPTION	DIMENSIONS
	<p>P600 = 0 (Default) Cylindrical flat base</p>	<p>Cylinder Diameter</p>
	<p>P600 = 1 Rectangular, flat base</p>	<p>Width and Breadth</p>
	<p>P600 = 2 Cylindrical, cone base</p>	<p>Cylinder diameter and height of bottom</p>

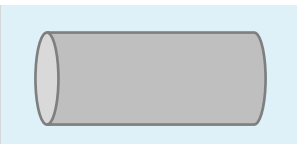
VESSEL SHAPE	P600 VALUE DESCRIPTION	DIMENSIONS
	<p>P600 = 3 Rectangular, pyramid base</p>	<p>Height of base, Width and Breadth of Rectangle</p>
	<p>P600 = 4 Parabola base</p>	<p>Cylinder diameter and height of bottom</p>
	<p>P600 = 5 Cylindrical half sphere</p>	<p>Cylinder Diameter</p>
	<p>P600 = 6 Cylindrical, flat sloped base</p>	<p>Cylinder diameter and height of bottom</p>
	<p>P600 = 7 Rectangular, flat sloped base</p>	<p>Width and breadth of rectangular section and height of bottom</p>

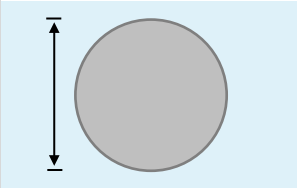
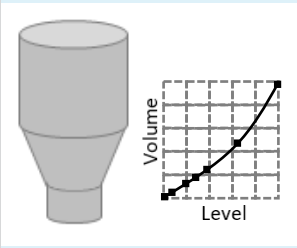
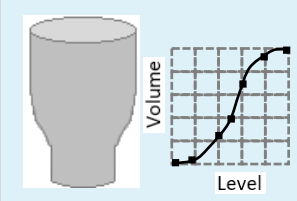
VESSEL SHAPE	P600 VALUE DESCRIPTION	DIMENSIONS
	<p>P600 = 8 Horizontal cylinder with flat ends</p>	<p>Cylinder diameter and tank length</p>
	<p>P600 = 9 Horizontal cylinder with parabolic ends</p>	<p>Cylinder diameter, length of one end and section, and tank length</p>
	<p>P600 = 10 Sphere</p>	<p>Sphere diameter</p>
	<p>P600 = 11 Universal linear</p>	<p>No dimensions required as level and volume breakpoints are used</p>
	<p>P600 = 12 Universal curved</p>	<p>No dimensions required as level and volume breakpoints are used</p>

P601-P603 Vessel Dimensions

These three parameters are used to enter the dimension required to calculate the volume. The dimensions required are as shown below and are entered **Measurements Units (P104)**.

VESSEL SHAPE	P601	P602	P603
P600 = 0 Cylindrical flat base	Cylinder Diameter	Not required	Not required
P600 = 1 Rectangular flat base	Not required	Width of rectangle	Breadth of rectangle
P600 = 2 Cylindrical cone base	Height of base	Width of rectangle	Not required
P600 = 3 Rectangular pyramid base	Height of base	Width of rectangle	Breadth of rectangle
P600 = 4 Cylindrical parabola base	Height of base	Cylinder Diameter	Not required
P600 = 5 Cylindrical half sphere base	Cylinder Diameter	Not required	Not required
P600 = 6 Cylindrical flat sloped base	Height of base	Cylinder Diameter	Not required
P600 = 7 Rectangular flat sloped base	Height of base	Width of rectangle	Breadth of rectangle
P600 = 8 Horizontal cylinder flat ends	Length of cylinder	Cylinder Diameter	Not required
P600 = 9 Horizontal cylinder parabolic ends	Length of cylinder	Cylinder Diameter	Length of one end
P600 = 10 Sphere	Sphere diameter	Not required	Not required

P604 Calculated Volume

This parameter displays the maximum volume that has been calculated by the sensor and is a Read Only parameter. The volume displayed will be shown in cubic meters and is the total volume available between **Empty Level (P105)** and 100 % of **Span (P106)**.

P605 Volume Units

This parameter determines the units that you wish to display, for volume conversion. It is used in conjunction with **P607 (maximum volume)**, and the units are shown on the display.

The choices are:

OPTION	DESCRIPTION
0 = No units	Volume will be totalized with no units
1 = Tons	Volume will be totalised in Tons
2 = Long Tons	Volume will be totalised in Tonnes
3 = Cubic metres (Default)	Volume will be totalised in Cubic metres
4 = Litres	Volume will be totalised in Litres
5 = UK Gallons	Volume will be totalised in UK Gallons
6 = US Gallons	Volume will be totalised in US Gallons
7 = Cubic Feet	Volume will be totalised in ft³
8 = Barrels	Volume will be totalized in Barrels

P606 Correction Factor

This parameter is used to enter a correction factor, such as the specific gravity of a material, if required, to compensate for differences between calculated and actual vessel contents (e.g. due to different material densities).

Standard = 1

P607 Max Volume

This parameter displays the actual maximum volume that has been calculated by the sensor (i.e., **P604 Calculated Volume x P606 Correction Factor**) and is a Read Only parameter. The volume displayed will be shown in **P605 Volume Units** and is the total volume available between **empty level (P105)** and 100 % of **span (P106)**.

Breakpoints

P610-P641 Level/Volume Breakpoints

These parameters are used to create a profile of the vessel when **P600=11 (universal linear)** or **P600=12 (universal curved)**. You should enter breakpoints in pairs, a reading for level and its corresponding volume. The more pairs you enter, the more accurate the profile will be.

In the case of universal linear, then enter the level/volume at each of the points where the vessel changes shape.

In the case of the universal curved, enter values around each arc tangent as well as at the top and bottom.

You must enter at least two pairs, and you can enter up to 16 pairs.

Universal Linear (P600 = 11)

This volume calculation creates a linear approximation of the level/volume relationship and works best if the vessel has sharp angles between each section.

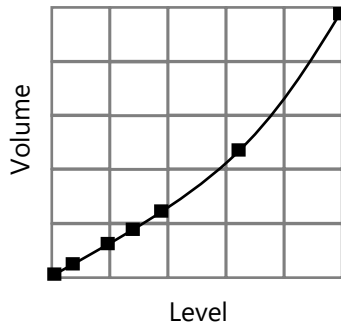

You should enter a level/volume breakpoint for each place where the vessel changes direction, and numerous where the section is slightly curved (mostly linear but has got a small arc). You can enter any number of pairs between 2 and 16.

Universal Curved (P600 = 12)

This volume calculation creates a curved approximation of the level/volume relationship, and works best if the vessel is non-linear, and there are no sharp angles.

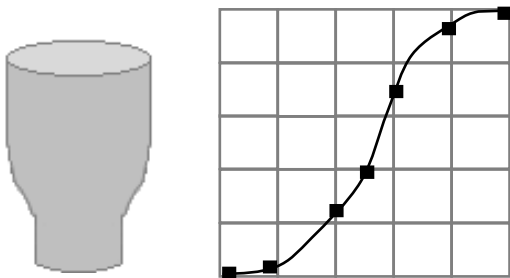

You should enter two level/volume breakpoints at the minimum and maximum levels and several for each place where the vessel has got an arc. You can enter any number of pairs between 2 and 16.

Tables

P696 Reset Breakpoints

This parameter allows the resetting, to the default value, of all previously set breakpoints (P610-641), without having to access them individually. When it is necessary to reset or amend breakpoints this can be achieved by directly accessing the desired parameter (P610-641) and changing as required.

P697 Number of Breakpoints Set

This parameter allows you to review the number of breakpoints that have been set, without the need to access each individual one in turn. This is a Read Only parameter and no values can be entered.

CHAPTER 6 TROUBLESHOOTING

This section describes many common symptoms, with suggestions as to what to do.

POSSIBLE CAUSES	ACTION
Sensor not firing.	Check power supply.
Unit indicates a "LOE Situation".	No valid echo being received, and unit has gone into fault condition. Check material level is not out of range, sensor is perpendicular to material surface and that the correct voltage is supplying the sensor.
Incorrect reading being obtained for current level.	Measure actual distance from transducer face to surface of material. Access P21 , via the Hart Communicator Software type in the measured distance , and Set Parameter .
4-20 mA current fixed even though the level is changing.	Poll address is above 0 and is in multi drop mode. Change poll address to 0 if using a single device. Check what demo mode is set to (P239; 0 = Off, 1 = On).
QR code doesn't work with IOS device.	Scan the QR code and copy the URL then paste into BlueFy browser.
Material level is consistently incorrect by the same amount.	Check empty level (P105) correctly entered.
LED is flashing yellow or red.	Please check to see what P241 Indicator is set to. The sensor may require correct alignment, or the sensor is in an alarm condition (LOE/Failed Safe). In this case please obtain an echo trace to verify all is well with the measurement. Incorrect voltage supplied to the sensor, please check supply.
Sensor is not displayed on the web-based user interface.	Make sure device is close to the sensor. Is the sensor inside a metal tank? Ensure no other device is connected. Check the Bluetooth mode using the NIVUS Ri-Series radar sensor software. Disconnect the power supply briefly and then re-start the sensor.

CHAPTER 7 DISPOSAL

Incorrect disposal can cause adverse effects to the environment.

Dispose of the device components and packaging material in accordance with regional environmental regulations including regulations for electrical / electronic products.

Transducers

Remove power, disconnect the Transducer, cut off the electrical cable and dispose of cable and Transducer in accordance with regional environmental regulations for electrical / electronic products.

Controllers

Remove power, disconnect the Controller, and remove battery (if fitted). Dispose of Controller in accordance with regional environmental regulations for electrical / electronic products.

Dispose of batteries in accordance with regional environmental regulations for batteries.



 EU WEEE Directive Logo

This symbol indicates the requirements of Directive 2012/19/EU regarding the treatment and disposal of waste from electric and electronic equipment.

CHAPTER 8 CERTIFICATES AND APPROVALS

DE / EN / FR

EU Konformitätserklärung

EU Declaration of Conformity

Déclaration de conformité UE

Für das folgend bezeichnete Erzeugnis:

For the following product:

Le produit désigné ci-dessous:



NIVUS GmbH
Im Taele 2
75031 Eppingen

Telefon: +49 07262 9191-0
Telefax: +49 07262 9191-999
E-Mail: info@nivus.com
Internet: www.nivus.de

Bezeichnung:	"Ex" Ri-Serien Radar Sensor
<i>Description:</i>	<i>"Ex" radar sensor</i>
<i>Désignation:</i>	<i>"Ex" capteur radar</i>
Typ / Type:	RI08... / RI20...

erklären wir in alleiniger Verantwortung, dass die auf dem Unionsmarkt ab dem Zeitpunkt der Unterzeichnung bereitgestellten Geräte die folgenden einschlägigen Harmonisierungsvorschriften der Union erfüllen:

we declare under our sole responsibility that the equipment made available on the Union market as of the date of signature of this document meets the standards of the following applicable Union harmonisation legislation:

nous déclarons, sous notre seule responsabilité, à la date de la présente signature, la conformité du produit pour le marché de l'Union, aux directives d'harmonisation de la législation au sein de l'Union:

- 2014/34/EU
- 2014/53/EU
- 2011/65/EU

Bei der Bewertung wurden folgende einschlägige harmonisierte Normen zugrunde gelegt bzw. wird die Konformität erklärt in Bezug auf die nachfolgend genannten anderen technischen Spezifikationen:

The evaluation assessed the following applicable harmonised standards or the conformity is declared in relation to other technical specifications listed below:

L'évaluation est effectuée à partir des normes harmonisées applicable ou la conformité est déclarée en relation aux autres spécifications techniques désignées ci-dessous:

- EN IEC 60079-0:2018
- EN 60079-11:2012
- EN 302 729 V2.1.1:2016
- EN 61326-1:2013
- EN 61010-1:2010 + A1:2019

Ex-Kennzeichnung / *Ex-designation / Marquage Ex :*



II 1 G Ex ia IIC T4 Ga, T_{amb} = -40 °C bis +80 °C



II 1 D Ex ia IIIC T100 °C Da, T_{amb} = -40 °C bis +80 °C

EU-Baumusterprüfbescheinigung / *EU-Type Examination Certificate / Attestation d'examen «UE» de type:*

CML 23ATEX2104X Issue 0

Notifizierte Stelle (Kennnummer) / *Notified Body (Identif. No.) / Organisme notifié (N° d'identification)*

CML B. V., Koopvaardijweg 32, 4906CV Oosterhout, The Netherlands (2776)

Qualitätssicherung ATEX / *Quality assurance ATEX / Assurance qualité ATEX:*

TÜV Nord CERT GmbH, Am TÜV 1, 45307 Essen, Germany (0044)

Diese Erklärung wird verantwortlich für den Hersteller:

This declaration is submitted on behalf of the manufacturer:

Le fabricant assume la responsabilité de cette déclaration:

NIVUS GmbH
Im Taele 2
75031 Eppingen
Germany

abgegeben durch / *represented by / faite par:*

Marcus Fischer (Geschäftsführer / *Managing Director / Directeur général*)

Eppingen, den 24.05.2023

Gez. *Marcus Fischer*



UK Declaration of Conformity

NIVUS GmbH
Im Taele 2
75031 Eppingen
Telefon: +49 07262 9191-0
Telefax: +49 07262 9191-999
E-Mail: info@nivus.com
Internet: www.nivus.de

For the following product:

Description:	"Ex" Ri-Series Radar Sensor
Type:	RI08... / RI20...



We declare under our sole responsibility that the equipment made available on the UK market as of the date of signature of this document meets the standards of the following applicable UK harmonisation legislation:

- SI 2016 / 1107 The Equipment and Protective Systems Intended for use in Potentially Explosive Atmospheres Regulations 2016
- SI 2017 / 1206 The Radio Equipment Regulations 2017
- SI 2012 / 3032 The Restriction of the Use of Certain Hazardous Substances in Electrical and Electronic Equipment Regulations 2012

The evaluation assessed the following applicable harmonised standards or the conformity is declared in relation to other technical specifications listed below:

- BS EN IEC 60079-0:2018
- BS EN 60079-11:2012
- BS EN 302 729 V2.1.1:2016
- BS EN 61326-1:2013
- BS EN 61010-1:2010 + A1:2019

Ex-designation:

 II 1G Ex ia IIC T4 Ga, T_{amb.} = -40 °C bis +80 °C
 II 1D Ex ia IIIC T100 °C Da, T_{amb.} = -40 °C bis +80 °C

EU-Type Examination Certificate:

CML 23ATEX2104X Issue 0

Approved Body (Identif. No.):

CML B. V., Koopvaardijweg 32, 4906CV Oosterhout, The Netherlands (2776)

Quality Assurance ATEX:

TÜV Nord CERT GmbH, Am TÜV 1, 45307 Essen, Germany (0044)

This declaration is submitted on behalf of the manufacturer:

NIVUS GmbH
Im Taele 2
75031 Eppingen
Germany

represented by:

Marcus Fischer (Managing Director)

Eppingen, 24/05/2023

Signed by *Marcus Fischer*

Q:\Formulare\CE\CE_Template_ex_02

**EU Type Examination Certificate CML 23ATEX2104X Issue 0**

- 1 Equipment intended for use in Potentially Explosive Atmospheres Directive 2014/34/EU
- 2 Equipment **Ri-Serie**
- 3 Manufacturer **NIVUS GmbH**
- 4 Address **Im Täle 2,
D-75031 Eppingen,
Germany**
- 5 The equipment is specified in the description of this certificate and the documents to which it refers.
- 6 CML B.V., Chamber of Commerce No 67386717, Koopvaardijweg 32, 4906CV Oosterhout, The Netherlands, Notified Body Number 2776, in accordance with Article 17 of Directive 2014/34/EU of the European Parliament and of the Council, dated 26 February 2014, certifies that this equipment has been found to comply with the Essential Health and Safety Requirements relating to the design and construction of equipment intended for use in potentially explosive atmospheres given in Annex II to the Directive.
The examination and test results are recorded in the confidential reports listed in Section 12.
- 7 If an 'X' suffix appears after the certificate number, it indicates that the equipment is subject to conditions of safe use (affecting correct installation or safe use). These are specified in Section 14.
- 8 This EU Type Examination certificate relates only to the design and construction of the specified equipment or component. Further requirements of Directive 2014/34/EU Article 13 apply to the manufacture of the equipment or component and are separately certified.
- 9 Compliance with the Essential Health and Safety Requirements, with the exception of those listed in the confidential report, has been demonstrated through compliance with the following documents:

EN IEC 60079-0:2018

EN 60079-11:2012

- 10 The equipment shall be marked with the following:



Ex ia IIC T4 Ga

Tamb= -40°C to + 80°C



Ex ia IIIC T100°C Da

Tamb= -40°C to +80°C



This certificate shall only be copied
in its entirety and without change
www.CMLEx.com

1 of 2



L A Brisk
Assistant Certification Manager



CML 23ATEX2104X
Issue 0

11 Description

The Ri-Series is a two-wire DC powered level measurement sensor utilising radar technology. The sensor is housed in a non-metallic enclosure with integral two core cable which connects, via a suitably certified barrier, to control equipment located in the safe area. The enclosure incorporates a threaded boss which allows the equipment to be mounted on a suitable bracket or flange, and LED indicators mounted in the enclosure wall.

Intrinsic safety is achieved by connecting to the non-hazardous area via an intrinsically safe interface device, and by encapsulation of the electronics and sensor.

The equipment has the following safety description:

U_i = 28V
I_i = 162mA
P_i = 0.85W
C_i = 0
L_i = 0

12 Certificate history and evaluation reports

Issue	Date	Associated report	Notes
0	21 Mar 2023	R16251A/00	Issue of Prime Certification

Note: Drawings that describe the equipment or component are listed in the Annex.

13 Conditions of Manufacture

The following conditions are required of the manufacturing process for compliance with the certification.

- i. Where the product incorporates certified parts or safety critical components, the manufacturer of the product defined on this certificate shall continually monitor these parts/components for any modifications introduced by the manufacturer(s) of these constituent parts. If the manufacturer of any constituent part introduces any changes which affect the compliance of the certified product that is the subject of this certificate, the manufacturer is required to have this certificate updated.

14 Specific Conditions of Use (Special Conditions)

The following conditions relate to safe installation and/or use of the equipment.

- i. Under certain extreme circumstances, the non-metallic parts incorporated in the enclosure of this equipment may generate an ignition-capable level of electrostatic charge. Therefore, the equipment shall not be installed in a location where the external conditions are conducive to the build-up of electrostatic charge on such surfaces. This is particularly important if the equipment is installed in a zone 0 location. In addition, the equipment shall only be cleaned with a damp cloth.
- ii. When installing the equipment, the installer shall consider the length of the integral cable attached to the equipment, in addition to any externally installed cable. The integral cable shall be considered to have parameters of 200pF/m, and 1µH/m or 30µH/Ω

This certificate shall only be copied in its entirety and without change
www.CMLEx.com

2 of 2

Version: 6.0 Approval: Approved

Certificate Annex

Certificate Number CML 23ATEX2104X
Equipment Ri-Serie
Manufacturer NIVUS GmbH



The following documents describe the equipment or component defined in this certificate:

Issue 0

Drawing No	Sheets	Rev	Approved date	Title
D-804-1503-A	1 of 1	A	21 Mar 2023	Nivus Ri-Serie sensor, Exia, IECEx & ATEX haz. area label.

This certificate shall only be copied
in its entirety and without change
www.CMLEx.com

1 of 1

Version: 6.0 Approval: Approved

	<h2 style="text-align: center;">IECEX Certificate of Conformity</h2>		
INTERNATIONAL ELECTROTECHNICAL COMMISSION IEC Certification System for Explosive Atmospheres <small>for rules and details of the IECEX Scheme visit www.iecex.com</small>			
Certificate No.:	IECEX CML 23.0039X	Page 1 of 3	Certificate history
Status:	Current	Issue No: 0	
Date of Issue:	2023-03-21		
Applicant:	NIVUS GmbH Im Tale 2 75031 Eppingen Germany		
Equipment:	Ri- Serie		
Optional accessory:			
Type of Protection:	Intrinsically Safe Ex "ia"		
Marking:	Ex ia IIC T4 Ga Ex ia IIIC T100°C Da Tamb = -40°C to +80°C		
Approved for issue on behalf of the IECEX Certification Body:		L A Brisk	
Position:		Assistant Certification Manager	
Signature: (for printed version)			
Date: (for printed version)		2023-03-21	
<ol style="list-style-type: none">1. This certificate and schedule may only be reproduced in full.2. This certificate is not transferable and remains the property of the issuing body.3. The Status and authenticity of this certificate may be verified by visiting www.iecex.com or use of this QR Code.			
Certificate issued by:			
Eurofins E&E CML Limited Unit 1, Newport Business Park New Port Road Ellesmere Port, CH65 4LZ United Kingdom		 	



IECEX Certificate of Conformity

Certificate No.: **IECEX CML 23.0039X**

Page 2 of 3

Date of issue: 2023-03-21

Issue No: 0

Manufacturer: **NIVUS GmbH**
Im Tale 2
75031 Eppingen
Germany

Manufacturing
locations:

This certificate is issued as verification that a sample(s), representative of production, was assessed and tested and found to comply with the IEC Standard list below and that the manufacturer's quality system, relating to the Ex products covered by this certificate, was assessed and found to comply with the IECEX Quality system requirements. This certificate is granted subject to the conditions as set out in IECEX Scheme Rules, IECEX 02 and Operational Documents as amended

STANDARDS :

The equipment and any acceptable variations to it specified in the schedule of this certificate and the identified documents, was found to comply with the following standards

[IEC 60079-0:2017](#) Explosive atmospheres - Part 0: Equipment - General requirements
Edition:7.0

[IEC 60079-11:2011](#) Explosive atmospheres - Part 11: Equipment protection by intrinsic safety "I"
Edition:6.0

This Certificate **does not** indicate compliance with safety and performance requirements other than those expressly included in the Standards listed above.

TEST & ASSESSMENT REPORTS:

A sample(s) of the equipment listed has successfully met the examination and test requirements as recorded in:

Test Report:

[GB/CML/EXTR23.0047/00](#)

Quality Assessment Report:

[DE/TUN/QAR13.0011/09](#)



IECEx Certificate of Conformity

Certificate No.: **IECEx CML 23.0039X**

Page 3 of 3

Date of issue: 2023-03-21

Issue No: 0

EQUIPMENT:

Equipment and systems covered by this Certificate are as follows:

The Ri-Series is a two-wire DC powered level measurement sensor utilising radar technology. The sensor is housed in a non-metallic enclosure with integral two core cable which connects, via a suitably certified barrier, to control equipment located in the safe area.

See Annex for full description and Conditions of Manufacture.

SPECIFIC CONDITIONS OF USE: YES as shown below:
See Annex for Specific Conditions of Use.

Annex:

[IECEx CML 23.0039X Iss. 0 Annex.pdf](#)



CML



Annexe to: IECEx CML 23.0039X, Issue 0

Applicant: NIVUS GmbH

Apparatus: Ri-Serie

Description

The Ri-Series is a two-wire DC powered level measurement sensor utilising radar technology. The sensor is housed in a non-metallic enclosure with integral two core cable which connects, via a suitably certified barrier, to control equipment located in the safe area. The enclosure incorporates a threaded boss which allows the equipment to be mounted on a suitable bracket or flange, and LED indicators mounted in the enclosure wall.

Intrinsic safety is achieved by connecting to the non-hazardous area via an intrinsically safe interface device, and by encapsulation of the electronics and sensor.

The equipment has the following safety description:

U_i = 28V
I_i = 162mA
P_i = 0.85W
C_i = 0
L_i = 0

Conditions of Manufacture

The following conditions are required of the manufacturing process for compliance with the certification.

- i. Where the product incorporates certified parts or safety critical components, the manufacturer of the product defined on this certificate shall continually monitor these parts/components for any modifications introduced by the manufacturer(s) of these constituent parts. If the manufacturer of any constituent part introduces any changes which affect the compliance of the certified product that is the subject of this certificate, the manufacturer is required to have this certificate updated.

Specific Conditions of Use

The following conditions relate to safe installation and/or use of the equipment.

- i. Under certain extreme circumstances, the non-metallic parts incorporated in the enclosure of this equipment may generate an ignition-capable level of electrostatic charge. Therefore, the equipment shall not be installed in a location where the external conditions are conducive to the build-up of electrostatic charge on such surfaces. This is particularly important if the equipment is installed in a zone 0 location. In addition, the equipment shall only be cleaned with a damp cloth.
- ii. When installing the equipment, the installer shall consider the length of the integral cable attached to the equipment, in addition to any externally installed cable. The integral cable shall be considered to have parameters of 200pF/m, and 1µH/m or 30µH/Ω.



Certificate Annex IECEx
Version: 9.0 Approval: Approved

1 of 1

Eurofins E&E CML Limited
Newport Business Park
New Port Road
Ellesmere Port
CH65 4LZ

T +44 (0) 151 559 1160
E info@cmlcx.com

www.cmlcx.com

Company Reg No: 854622 VAT No: GB15302842