

Instruction Manual

Flow Measurement Transmitter for Radar Sensors NivuFlow 550



Firmware Revision: 2.09

Original Manual: German

NIVUS AG, Switzerland

Burgstrasse 28
CH - 8750 Glarus
Phone: +41 (0)55 6452066
Fax: +41 (0)55 6452014
E-mail: swiss@nivus.com
Internet: www.nivus.de

NIVUS, Austria

Muehlbergstraße 33B
A-3382 Loosdorf
Phone: +43 (2754) 567 63 21
Fax: +43 (2754) 567 63 20
E-mail: austria@nivus.com
Internet: www.nivus.de

NIVUS, France

14, rue de la Paix
F - 67770 Sessenheim
Phone: +33 (0)3 88071696
Fax: +33 (0)3 88071697
E-mail: info@nivus.fr
Internet: www.nivus.fr

NIVUS Ltd., United Kingdom

Head office UK:
Wedgewood Rugby Road
Weston under Wetherley
Royal Leamington Spa
CV33 9BW, Warwickshire
Phone: +44 (0)8445 3328 83
E-Mail: nivusUK@nivus.com
Internet: www.nivus.com

NIVUS Sp. z o.o., Poland

ul. Hutnicza 3 / B-18
PL - 81-212 Gdynia
Phone: +48 (0) 58 7602015
Fax: +48 (0) 58 7602014
E-mail: poland@nivus.com
Internet: www.nivus.pl

NIVUS Middle East (FZE)

Building Q 1-1 ap. 055
P.O. Box: 9217
Sharjah Airport International
Free Zone
Phone: +971 6 55 78 224
Fax: +971 6 55 78 225
E-mail: Middle-East@nivus.com
Internet: www.nivus.com

NIVUS Korea Co. Ltd.

#2502, M Dong, Technopark IT Center,
32 Song-do-gwa-hak-ro, Yeon-su-gu,
INCHEON, Korea 406-840
Phone: +82 32 209 8588
Fax: +82 32 209 8590
E-mail: korea@nivus.com
Internet: www.nivus.com

NIVUS Vietnam

21 Pho Duc Chinh, Ba Dinh,
Hanoi, Vietnam
Mobile (VN) 012 0446 7724
E-mail: vietnam@nivus.com

Copyrights and property rights

This document and its contents are proprietary to NIVUS GmbH and are not to be reproduced or copied without the express written permission of NIVUS GmbH.

Violations oblige to compensation.



Important Note

This instruction manual may exclusively - even in parts - be copied or translated in any other way with the express written consent of NIVUS GmbH.

Translation

If the device is sold to a country in the European Economic Area (EEA) this instruction manual must be translated into the language of the country in which the device is to be used.

Should the translated text be unclear, the original instruction manual (German) must be consulted or the manufacturer contacted for clarification.

Copyright

No part of this publication may be reproduced, transmitted, sold or disclosed without prior permission. Damages will be claimed for violations.

All rights reserved.

Names

The use of general descriptive names, trade names, trade-marks and the like in this manual does not entitle the reader to assume they may be used freely by everyone. They are often protected registered trademarks even if not marked as such.

Modifications

Rev.	Modifications	Person in charge	Date
00	First version	MoG	12.04.2017

Table of contents

COPYRIGHTS AND PROPERTY RIGHTS	3
MODIFICATIONS	4
GENERAL	11
1 About this manual	11
1.1 Applicable documentation	11
1.2 Signs and definitions used	11
1.3 Abbreviations used	12
2 Connections and user elements	12
2.1 Power supply	12
2.2 NivuFlow control elements	13
2.3 Tasks of control elements	13
2.4 Interfaces	14
SAFETY INSTRUCTIONS	15
3 In general: Used symbols and signal words	15
3.1 Valuation of the accident level	15
3.2 Warning notices on the product	16
4 Safeguards and Precautions	16
5 Liability disclaimer	17
6 Use in accordance with the requirements	17
7 User's Responsibilities	18
8 Personnel requirements	19

PRODUCT SPECIFICATION **20**

9	Product construction and overview	20
9.1	Dimensions of enclosure	20
9.2	Connectable sensors	21
9.3	Device identification	21
10	Specifications	23
11	Configuration	24
11.1	Device Types	24
11.2	Delivery	24
11.3	Reception inspection	24
11.4	Storing	25
11.5	Transport	25
11.6	Return	25
11.7	Installation of spare parts and parts subject to wear and tear	25

FUNCTIONAL PRINCIPLE **26**

12	Operating Range.....	26
13	Functional Principles	26
13.1	Flow Velocity Measurement.....	26
13.1.1	Surface Radar	26
13.2	Level measurement	27
13.2.1	External level sensor	27

INSTALLATION AND CONNECTION **28**

14	Installation Instructions	28
14.1	Hints on how to avoid electrostatic discharge (ESD).....	28
14.2	Choosing the installation place	28
14.3	Fastening the Transmitter	29
15	Electric Installation.....	29
15.1	Power and Relay Connections	30

15.1.1	Clamps for Protective Conductor Terminal and AC Supply	30
15.1.2	Power supply DC.....	30
15.1.3	Power supply AC	30
15.1.4	Relays.....	31
16	Installation of sensors	32
16.1	Sensor Installation Principles.....	32
16.2	Preparations for Sensor Installation.....	32
17	Sensor Connection.....	33
17.1	Cable and cable lengths for sensor connection.....	33
17.2	Sensor Connection at NivuFlow	34
17.3	Overvoltage Protection	36
18	Transmitter Connection	39
18.1	Connection to the Terminal Blocks	39
18.1.1	Connection Diagrams	40
18.2	Switching on voltage supply	41
OPERATION START-UP		43
19	Notes to users.....	43
20	Operation Basics	44
20.1	Display Overview	44
20.2	Using the Control elements	44
20.3	Use/Entry using the letter block	45
20.4	Use/Entry using the numeric keypad	46
20.5	Revision of parameters.....	47
20.6	Menus	47
SETTING PARAMETERS		48
21	General Programming.....	48
21.1	Save Parameters	48
21.2	Change Password	48

22	Parameter Functions	49
22.1	Main Menu	49
22.2	Functions Top Menu Level.....	49
22.2.1	Application Menu	49
22.2.2	Data Menu.....	50
22.2.3	System Menu.....	51
22.2.4	Communication Menu.....	51
22.2.5	Display Menu.....	52
22.2.6	Connections Menu.....	52
23	Description of Parameters	53
23.1	Setting the Measurement Place Parameters (Application Menu) .	53
23.1.1	Name of Measurement Place	53
23.1.2	Channel Profiles	54
23.1.3	Sludge Level.....	59
23.1.4	Flow Velocity Evaluation.....	59
23.1.5	Low-Flow Suppression	60
23.1.6	Damping	61
23.1.7	Stability.....	61
23.2	Setting Parameters in h-Sensors Menu.....	61
23.2.1	h-Sensor Types	61
23.2.2	Definition of Measurement Ranges	63
23.3	Setting Parameters in v-Sensors Menu	66
23.3.1	Number of Flow Velocity Sensors.....	66
23.3.2	Sensor Types.....	66
23.3.3	Sensor Mounting Position.....	66
23.3.4	v-Minimum and v-Maximum	68
23.3.5	Data Transmission Rate	68
23.4	Inputs and Outputs (analog and digital).....	69
23.4.1	Analog Inputs.....	69
23.4.2	Analog Outputs.....	71
23.4.3	Digital Inputs.....	73
23.4.4	Digital Outputs	75
23.5	Diagnosis	78
24	Data Parameter Menu	79
24.1	Trend.....	79

24.2	Day Totals	82
24.3	USB-Transfer	83
24.4	Data Memory (Internal).....	88
25	System.....	89
25.1	Information	89
25.2	Language Settings.....	90
25.2.1	(Operation) Language	90
25.2.2	Date Format.....	90
25.2.3	Units	90
25.2.4	Memory Units	92
25.3	Time/Date	93
25.4	Error Messages	94
25.5	Service.....	94
25.5.1	Change (System) Password.....	95
25.5.2	Restart.....	95
25.5.3	Measurement Restart.....	95
25.5.4	Parameter Reset	96
26	Communication Parameters Menu	96
27	Display Parameters Menu.....	98
28	Connections.....	100
MAIN DISPLAY		101
29	General overview.....	101
29.1	Display Flow	102
29.1.1	Menu Settings (Flow).....	103
29.1.2	Menu Diagnostics (Flow).....	103
29.1.3	Menu Display (Flow).....	104
29.1.4	Menu Error messages (Flow)	104
29.2	Display Level	105
29.2.1	Menu Settings (Level).....	105
29.2.2	Menu Diagnostics (Level).....	106
29.2.3	Menu Display (Level).....	106

29.3	Display Velocity.....	106
29.3.1	Menu Settings (Velocity).....	107
29.3.2	Menu Diagnostics (Velocity)	107
29.4	Display Temperature and Sum	108
29.5	Display Trend/Hydrograph	108

DIAGNOSIS **109**

30	Basics of Diagnosis Menus	109
31	Diagnosis h-Sensors	110
32	Diagnosis v-Sensors	111
33	Inputs and Outputs (Analog and Digital).....	112
33.1	Analog Inputs.....	112
33.2	Analog Outputs	113
33.3	Digital Inputs	115
33.4	Digital Outputs	115
34	Simulation	117

MAINTENANCE AND CLEANING **119**

35	Maintenance.....	119
35.1	Maintenance interval.....	119
35.2	Customer Service Information	119
36	Cleaning	120
36.1	Transmitter.....	120
36.2	Sensors.....	120
37	Dismantling/Disposal	120
38	Accessories	121

General

1 About this manual



Note

READ CAREFULLY BEFORE USE!
KEEP IN A SAFE PLACE FOR LATER REFERENCE!

This instruction manual is an original instruction for the flow measurement transmitter NivuFlow 550 and is for the intended use of the device. This manual is oriented exclusively to qualified expert personnel.

Read this instruction manual carefully and completely prior to installation and connection since it contains relevant information on this product. Observe the notes and particularly follow the warning notes and safety instructions.

Keep this manual in a safe place and make sure it is available for the users of this product at any time.

If you should have problems to understand information contained within this instruction manual either contact the manufacturer or one of the distributors for further support. The manufacturer cannot be held responsible for damage to persons or material due to incorrectly understood information in this instruction.

In case of selling the instrument this instruction manual shall be provided to the purchaser since it is a part of the standard delivery.



1.1 Applicable documentation

For the installation and operation of the complete system extra instruction manuals or technical descriptions may be required apart from this manual.

- Technical Description for Ex-Separator Module iXT
- Technical and Installation Instruction for Radar Sensors OFR
- Instruction Manual for i-Series Intelligent Sensors
- Technical Information USB HART Modem

These manuals are provided with the auxiliary units or sensors and/or are available as download on the NIVUS homepage.

1.2 Signs and definitions used

Image	Meaning	Remark
	(Action) Step	Action to be performed by you. Note the numbering of action steps. Observe the order of the working steps!
	Cross-reference	Reference to further or detailed information.
>Text<	Parameter or Menu	Indicates a parameter or a menu that is selected or described.
	Reference to document	Refers to an accompanying documentation.

1.3 Abbreviations used

Colour code for wires, single conductors and components.

The abbreviations of colours, wire and components follow the international colour code according to IEC 757.

BK	black	RD	red	TR	transparent
BU	blue	WH	white	GNYE	green/yellow
GN	green	YE	yellow	BN	brown
GY	grey	PK	pink		

2 Connections and user elements

2.1 Power supply

The connection for power supply is located on the lower part of the plug-in module X1.

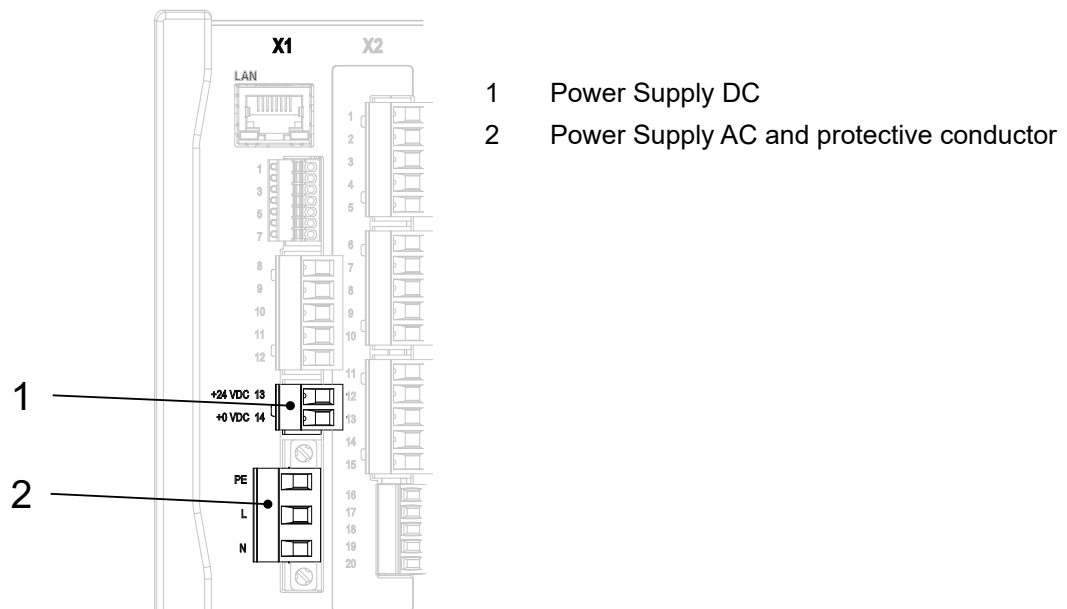

Fig. 2-1 Electrical connections of power supply

➡ You can find a detailed connection plan in chapter „18.1.1 Connection Diagrams“.

2.2 NivuFlow control elements

The NivuFlow is operated completely in dialogue mode supported by the graphs on the display. To select individual menus and sub-menus use the rotary pushbutton as well as the both function keys.

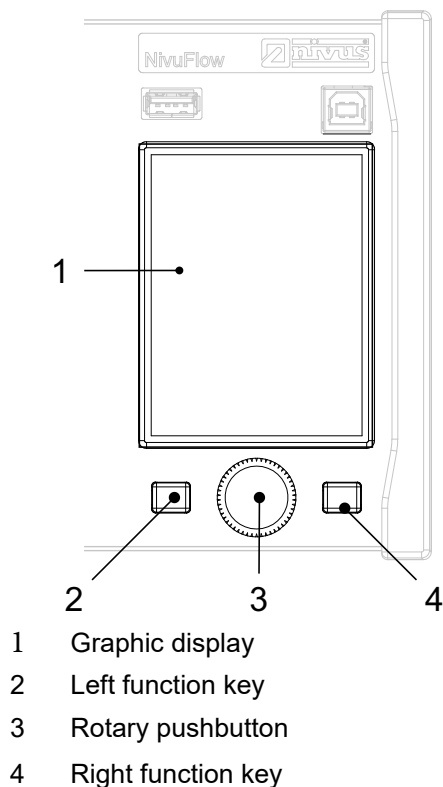

Fig. 2-2 Control elements

2.3 Tasks of control elements

Colour display

You can read all settings, when parameter setting and in diagnostics.

Left function key

Initially, this key takes you to the menu. They key is also used to exit menus or sub-menus.

Rotary pushbutton

Use the rotary pushbutton to enter specific sub-menus. The functions can be selected using the rotary pushbutton as well.

- Select the desired parameter or menus
- Navigation through the sub-menus and settings
- Selection of letters or numbers for parameter setting

Right function key

This key is used to confirm value entries (via numeric keys or letter keys).

For some parameters the right function key can be used as >TAB<. This TAB function is active only with the settings below:

- Menu application
 - Selection of v-sensors
 - Diagnostics v-sensors
 - Selection of analog inputs (AI)
 - Selection of analog outputs (AO)
 - Selection of digital inputs (DI)
 - Selection of digital outputs (DO)
- Menu data
 - Selection of trend and day totals



You will find a description on how to use the control elements in chapter „20 Operation Basics“.

2.4 Interfaces

The transmitter has several interfaces on the front panel.

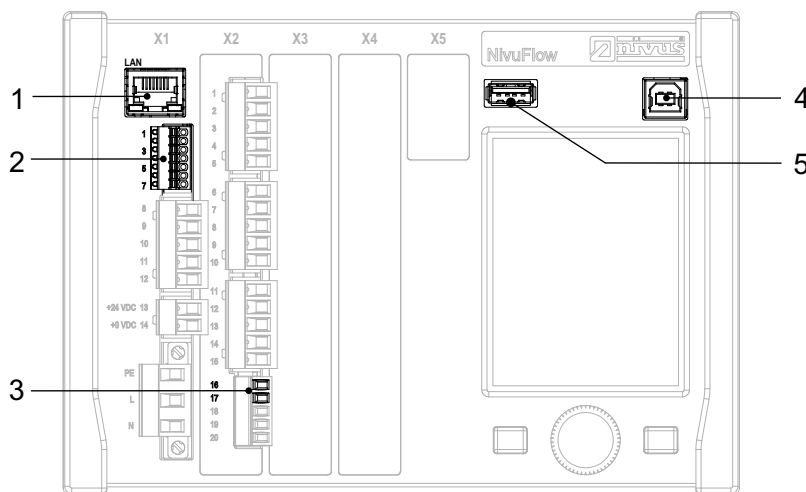

- 1 Network interface (LAN)
- 2 Bus interface (RS485/RS232)
- 3 HART-interface (upon request)
- 4 USB-B-interface (service)
- 5 USB-A-interface (data transfer)

Fig. 2-3 Available interfaces



Descriptions of the individual interfaces see chapter „26 Communication Parameters Menu“.

Safety Instructions

3 In general: Used symbols and signal words

3.1 Valuation of the accident level



The general warning symbol indicates the risk of personal injuries or death. In the text section the general warning symbol is used in conjunction with the signal words described below.

DANGER

Warnings in high degree of risk



Indicates a high-risk, imminently hazardous situation which will result in death or serious injury if not avoided.

WARNING

Warnings in medium degree of risk



Indicates a possible danger with medium risk which may result in a life-threatening situation or (severe) bodily injury if it is not avoided.

CAUTION

Warnings in low-risk or property damages



Indicates a possible danger with moderate risk which may result in minor or moderate personal injury or material damage if not avoided.

WARNING

Danger by electric voltage



Indicates a hazard with a high risk of electric shock which may result in a life-threatening situation or (severe) bodily injury if it is not avoided.



Important Note

Contains information that should be highlighted.

Indicates a potentially damaging situation which can result in a damage of the product or an object in its environment.



Note

Contains information and facts.

3.2 Warning notices on the product

**General warning label**

*This symbol is for operators to refer to this instruction manual.
Observing the information contained therein is required in order to maintain protection measured provided by the instrument during installation procedures and operation.*

**Protective conductor**

*This symbol refers to the protective conductor of the unit.
Depending on the mode of installation the instrument shall be operated solely connected to an appropriate protective conductor according to applicable laws and regulations.*

4 Safeguards and Precautions

Working with NIVUS instruments requires to observe and to follow the safety measures and precautions below generally and at any time. These notes and warnings will not be repeated for each description within the document.

WARNING**Germ contamination**

*Please note that due to the operation in the waste water field the measurement system and cables may be loaded with dangerous disease germs. Respective precautionary measures must be taken to avoid damage to one's health.
Wear protective clothing.*

WARNING**Observe occupational safety regulations**

*Before starting installation work, observing the work safety regulations need to be checked.
Disregarding may lead in personal injury.*

WARNING**Do not disable safety devices**

*It is strictly prohibited to disable the safety devices or to change the way they work.
Disregarding may lead in personal injury.*

WARNING**Danger by electric voltage**

*Maintenance, cleaning and/or repairs (by qualified personnel only) may only be performed when de-energised.
Disconnect the systems from mains.
Disregarding may lead to electric shocks!*



Important Note

Before starting installation work, observing the work safety regulations need to be checked. It is strictly prohibited to disable the safety devices or to change the way they work.

5 Liability disclaimer

The manufacturer reserves the right to change the contents of this document including this liability disclaimer without prior notice and cannot be held responsible in any way for possible consequences resulting from such changes.

For connection, initial start-up and operation as well as maintenance of the unit the following information and higher legal regulations of the respective country (e. g. VDE regulations in Germany) such as applicable Ex regulations as well as safety requirements and regulations in order to avoid accidents shall be observed.

All operations on the device which go beyond installation or connection measures in principle shall be carried out by NIVUS staff or personnel authorised by NIVUS due to reasons of safety and guarantee.

Operate the transmitter only in technically perfect working order.

Improper Use

Not being operated in accordance with the requirements may impair the safety.

The manufacturer is not responsible for failures resulting from improper use.

6 Use in accordance with the requirements



Note

The instrument is intended solely for the purpose described below.

Modifying or using the instruments for any other purposes without the manufacturer's written consent will not be considered as use in accordance with the requirements.

The manufacturer cannot be held responsible for any damage resulting from improper use.

The user alone bears any risk.

The permanent flow meter Type NivuFlow 550 including the accompanying sensors is designed for continuous flow measurement of clear to heavily polluted media in part filled channels, pipes and similar.

NivuFlow 550 is designed and manufactured in accordance with the current state of the art and with the recognised safety rules and regulations applicable at the time this document is issued. Danger to persons or material damage cannot be completely ruled out, however.

The maximum permissible limit values as specified in chapter „10 Specifications“ shall be necessarily observed. Any case varying from these conditions which is not approved by NIVUS GmbH in written form is left at the owner's risk.

Ex protection

In order to use flow velocity sensors in Ex areas ensure to install an Ex-Separation Module between transmitter and sensor.

For wiring diagrams refer to the according instruction manual.



Important Note

Install the transmitter out of Ex zones!

The Ex approval of the sensors is part of the “Technical Description” and/or “Instructions Manual”.

The Ex approval of the Ex Separation Interface is part of the “Technical Description for iXT Ex Separation Interface”.



Important Note

For installation and commissioning the conformity certificates as well as the test certificates issued by the respective authorities shall be followed.

The combination of NivuFlow and the iXT Ex Separation Interface is adjusted solely to NIVUS correlation sensors regarding the intrinsically safe system review according to EN 60079-25.

In the event of using sensors by third-party manufacturers the operator shall carry out a system review according to EN 60079-25!

The required specifications of the iXT Ex Separation Interface can be found in the according EC type examination certificate.

7 User's Responsibilities



Important Note

In the EEA (European Economic Area) national implementation of the frame-work directive 89/391/EEC and corresponding individual directives, in particular the directive 2009/104/EC concerning the minimum safety and health requirements for the use of work equipment by workers at work, as amended, are to be observed and adhered to.

In Germany the Industrial Safety Ordinance must be observed.

Make sure to have a local operating permit available and observe the associated conditions. In addition to this you must observe environmental requirements and local laws on the following points:

- Personnel safety (accident prevention regulations)
- Safety of work materials and tools (safety equipment and maintenance)
- Disposal of products (laws on wastes)
- Disposal of materials (laws on wastes)
- Cleaning (cleansing agents and disposal)

Connections

Operators shall make sure prior to operating the instrument that during installation and initial start-up the local regulations (such as regulations for electrical connection) are observed.

8 Personnel requirements

Installation, commissioning and maintenance shall be executed only by personnel meeting the demands as follows:

- Expert personnel with relevant training and appropriate qualification
- Personnel authorised by the plant operator



Qualified personnel

within the context of this documentation or the safety notes on the product itself are persons who are sufficiently familiar with installation, mounting, starting up and operation of the product and who have the relevant qualifications for their work; for example:

- I. Training, instruction or authorisation to activate/deactivate, isolate, ground, and mark electric circuits and devices/systems according to the safety engineering standards.*
 - II. Education and instruction according to the standards of safety engineering regarding the maintenance and use of adequate safety equipment.*
 - III. First aid training Contains information and facts.*
-

Product specification

9 Product construction and overview

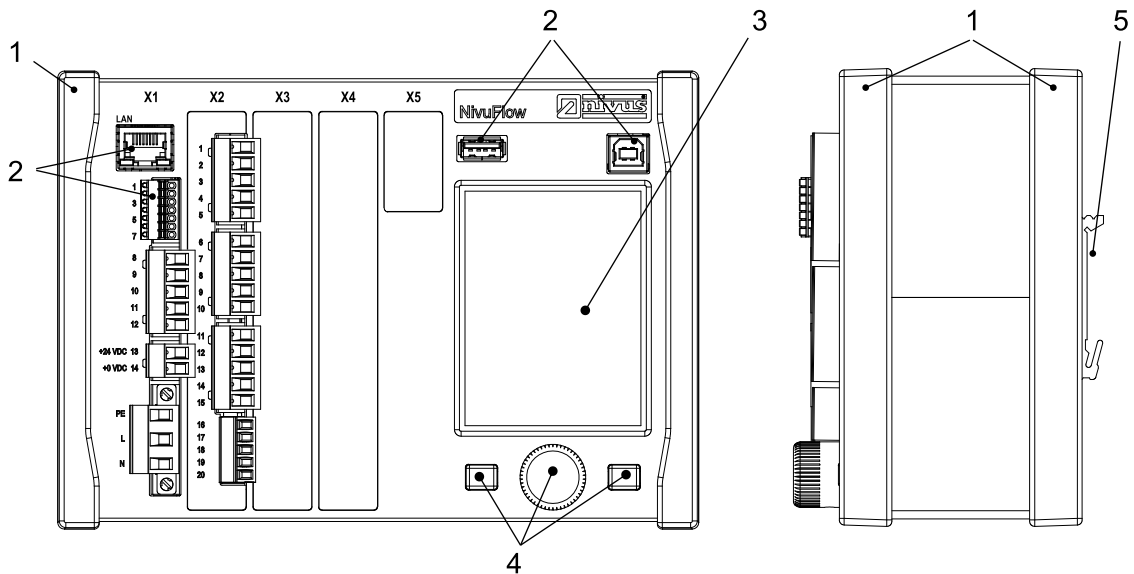

- 1 Trims/cover strips
 - 2 Interfaces
 - 3 Graphic display
 - 4 Control Elements
 - 5 DIN rail fastening
- X1 Power supply, air ultrasonic sensor connection via RS485, Interfaces (LAN and Bus)
- X2 Digital in-/outputs, 1x RS485 and analog in-/outputs

Fig. 9-1 Device setup NivuFlow 550

9.1 Dimensions of enclosure

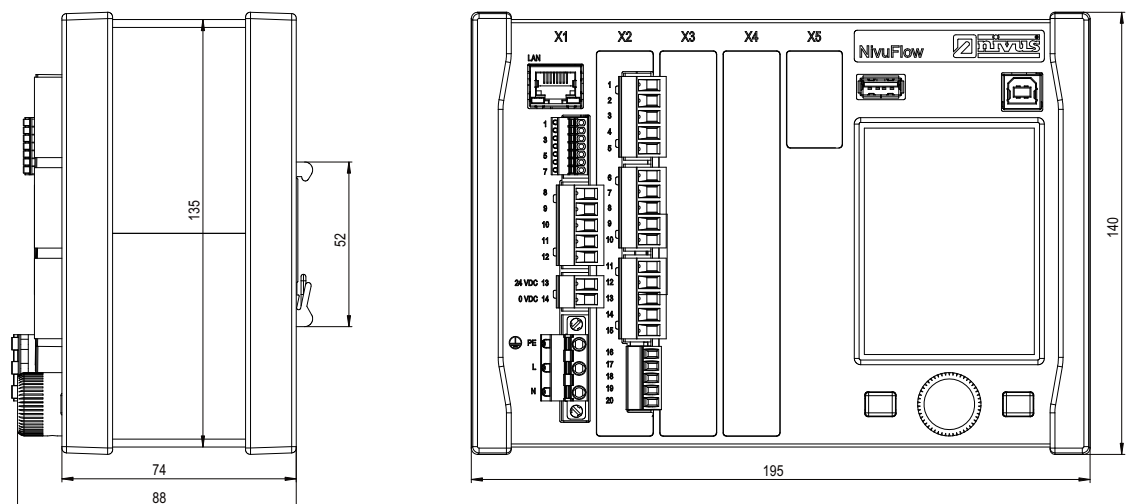
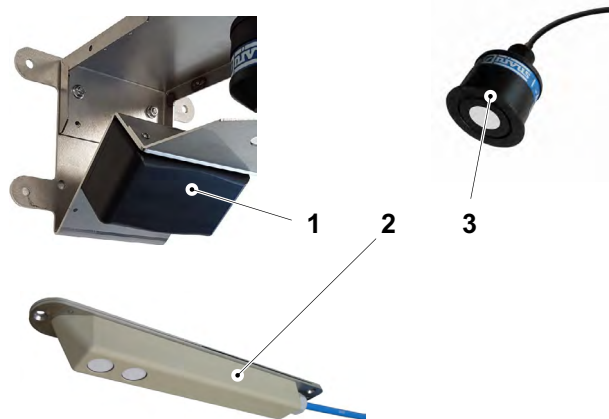

Fig. 9-2 Dimensions of the transmitter NivuFlow 550

9.2 Connectable sensors

The image below provides an overview on the connectable sensors.



- 1 Radar sensor OFR
- 2 Ultrasonic level sensor, Type OCL-L1 (option)
- 3 i-Series sensor NMI0

Fig. 9-3 Overview of connectable sensors

9.3 Device identification

The instructions contained within this manual are valid only for the type of device specified on the title page.

The name plate is fixed on the side of the enclosure and contains the following:

- Name and address of the manufacturer
- CE label
- Information on type and series, serial no. if available
- Power supply

In case of enquiries and ordering replacement parts it is important to specify article number as well as the serial number of the respective transmitter or sensor. This ensures correct and quick processing.



Note

Check the delivered instrument for accordance with your order by identifying the name-plate.

Check the nameplate for correct specification of the power supply.



The declaration of conformity is located at the end of the manual.

Nameplates

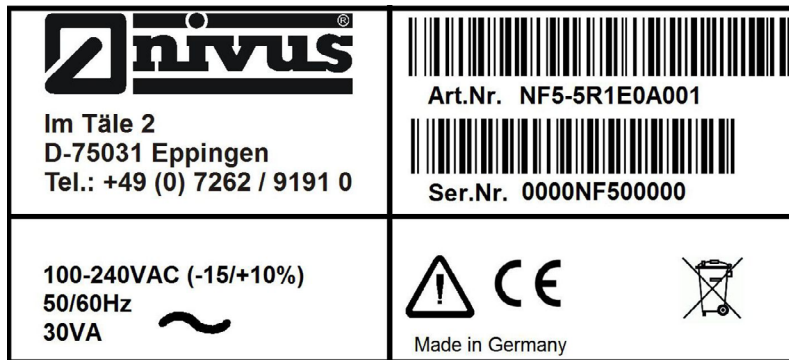

Fig. 9-4 Nameplate AC version

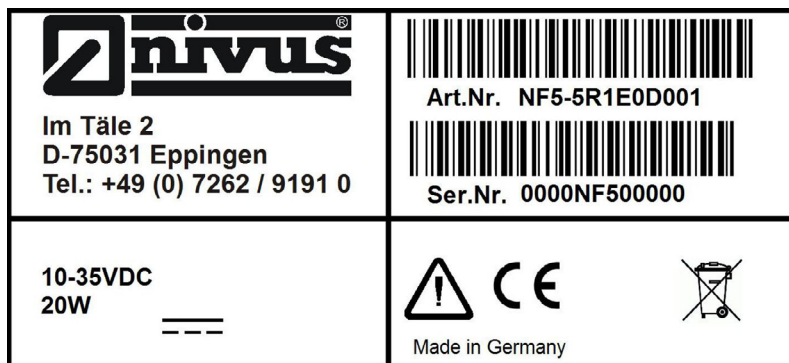

Fig. 9-5 Nameplate DC version

10 Specifications

Power supply	100...240 V AC, -15 % / +10 %, 47...63 Hz or 10...35 V DC
Supply connection	Plugged and screwed tension clamp terminal block
Max. power consumption	AC: 30 VA / DC: 20 W
Typ. power consumption	1x OFR + 1x i-Sensor + 1x relay energised, 230 V AC: (rounded) 14 W
Enclosure	Material: aluminium and plastic Weight: approx. 1150 g
Protection	IP20, shock resistance IK08
Operating conditions	Protection class I Overvoltage category II Pollution degree 2 AC unit for use in altitudes up to 3000 m above MSL. At relay voltages > 150 V the use is restricted to an altitude of max. 2000 m (AC and DC units)
Operating temperature	DC: -20...+70 °C AC: -20...+65 °C
Storage temperature	-30...+80 °C
Max. ambient temp. for installation and operation	+50 °C
Max. humidity	80 %, non-condensing
Display	TFT full graphic colour daylight display, 240x360 pixel, 65536 colours
Programming	Dialog mode using rotary pushbutton and two function keys, in German, English and French
Connection	Plug with spring-cage terminal clamps
Inputs	<ul style="list-style-type: none"> - 1x 4...20 mA for external level (2-wire probe) - 1x RxTx-Bus for NIVUS air-ultrasonic sensor Type OCL - 1x 0/4...20 mA with 12 Bit resolution for external level, external controller setpoint and data storage of external units, accuracy $\pm 0,4$ % of measuring range final value (20 mA), load 91 Ohm - 2x digital input - 1x Radar sensor (OFR) connectable
Outputs	<ul style="list-style-type: none"> - 2x 0/4...20 mA, load 500 Ohm - 12 Bit resolution, accuracy higher than $\pm 0,1$ % at 20 °C (higher than $\pm 0,4$ % at -20...+70 °C) - 1x bistable relay SPDT maximum load 230 V AC / 2 A (cos ϕ 0,9), min. switching current 100 mA - 1x relay SPDT, maximum load 230 V AC / 2 A (cos ϕ 0,9), min. switching current 10 mA
Data memory	Internal 1,0 GB, for programming and readings memory; read-out via front-side USB stick
Storage cycle	30 seconds to 5 minutes
Communication	<ul style="list-style-type: none"> - Modbus TCP via networks (LAN/WAN, Internet) - Modbus RTU via RS485 or RS232 - Internet via Ethernet (in preparation)

Sensors

Observe the specifications of the according sensors as described in the respective instruction manuals or technical descriptions.

11 Configuration

11.1 Device Types

The NivuFlow is available in different versions which mainly vary in terms of the number of connectable sensors. The article number can be found on the nameplate which is fixed on the side of the enclosure (see Nameplates on page 22).

NF5- Transmitter

Type	
5	For part filled applications
Type	
R1	1x Radar sensor (type OFR) and 1x Level sensor (i-Sensor), 2x DI, 2x DO, 2x AI, 2x AO
Enclosure and structure	
E0	DIN rail mounting/installation in switching cabinet
E1	DIN rail, prepared for mounting into NIVUS field enclosure, type ZUB0 NFW0
Power supply	
A0	100...240 V AC
D0	10...35 V DC
Firmware extensions	
0	none
Number of measurement places	
1	1 measurement place

11.2 Delivery

The standard delivery of the NivuFlow 550 contains:

- The instruction manual including the certificate of conformity and approvals. It contains any relevant information on how to operate the NivuFlow.
- A transmitter type NivuFlow corresponding to the shipping documents.

Check additional accessories depending on your order and according to the delivery note.

11.3 Reception inspection

Check the packaging for visible damage immediately after receipt. Any possible damage in transit shall be instantly reported to the carrier. Furthermore a written report shall be sent to NIVUS GmbH in Eppingen.

Incomplete deliveries shall be reported in writing either to your local representative or directly to the NIVUS head office in Eppingen within two weeks.



Note

Mistakes cannot be rectified later!

11.4 Storing

Observe the minimum and maximum values on environmental conditions such as temperature and humidity according to chapter „10 Specifications“.

The NivuFlow shall be protected from corrosive or organic solvent vapours, radioactive radiation as well as strong electromagnetic radiation. Always store the instrument in its original packaging.

11.5 Transport

Do not expose the system to heavy shocks or vibrations. Use the original packaging for transport.

11.6 Return

In case of a required reshipment return the unit at customer cost to NIVUS GmbH in Eppingen using the original packaging.

Insufficiently franked shipments will not be accepted!

11.7 Installation of spare parts and parts subject to wear and tear

We herewith particularly emphasise that replacement parts or accessories not supplied by NIVUS moreover are not certified and approved by NIVUS too. Installation and/or the use of such products hence may negatively influence predetermined constructional characteristics of the measurement system or even lead to instrument failures.

NIVUS cannot be held responsible for any damage resulting due to the use of non-original parts and non-original accessories.



You can find original manufacturer spare parts or accessories in chapter „38 Accessories“ and/or in the valid price list.

Functional Principle

12 Operating Range

The NivuFlow 550 is a non-portable measurement system for flow measurement. The equipment is conceived preferably for measurements in clear to heavily polluted aqueous liquids with various compositions.

The system can be used in part filled flumes, channels and pipes featuring various shapes and dimensions.

You can find an overview on connectable sensors in chapter „9.2 Connectable sensors“. The use of several sensors supports the more accurate detection of flow velocities on a common measurement place.



Note to the Radar measurement method

The measurement method used to determine the surface velocity is based on the Doppler principle.

The Radar sensor transmits a signal. The signal hits the waves on the water surface, is reflected and is re-detected by the sensor. The reflection from the water surface causes a frequency shift.

The Radar sensor measures the wave movement and computes the liquid's surface velocity from this movement. Therefore it is indispensable to have (at least minor) movement of waves on the medium surface available.

13 Functional Principles

13.1 Flow Velocity Measurement

13.1.1 Surface Radar

The OFR surface radar system is aligned towards the flow direction. It transmits radar waves and receives the reflections from the waves on the water surface. Due to the difference between transmitted and received frequencies it is possible to calculate the velocity of the movement (Radar-Doppler effect).

The transmitter then uses complex integrated algorithms to compute the parameters below from the velocity determined from the water surface:

- Flow profile and
- average velocity within the wetted cross section

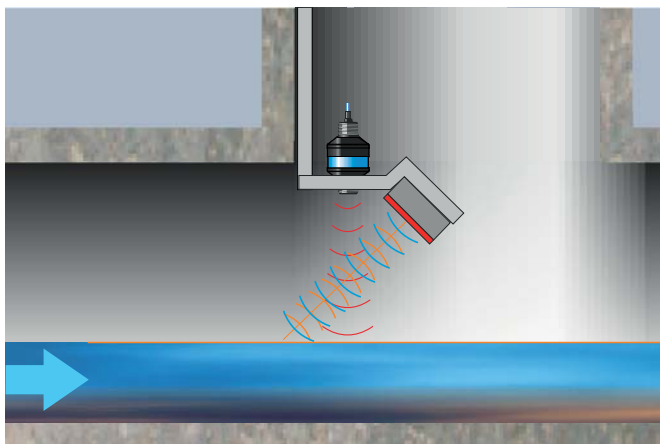

Fig. 13-1 Measurement using Surface Radar

13.2 Level measurement

13.2.1 External level sensor

Depending on the selected type of level measurement an external 4...20 mA signal may be used for the level (e. g. by using an i-Series sensor).

It is possible to directly connect 2-wire sensors supplied by the NivuFlow 550 (e. g. NivuBar, NivuCompact, i-Series sensor). A 4...20 mA signal provided by an external transmitter (such as 4...20 mA from NivuMaster) can be used as well.



Note

i-Series sensors have pre-programmed measurement ranges. For further reference please see the i-Series sensors instruction manual.

i-Sensors can be put into operation even without using a HART modem. To do so enter the sensor's measurement span in the parameter "Value at 20 mA". Depending on the sensor installation height it may be necessary to additionally set a negative offset value.

	i-3	i-6	i-10	i-15
Distance to sensor face in [m] at 4 mA (empty) 0 %	3.0	6.0	10.0	15.0
Distance to sensor face in [m] at 20 mA (full) 100 %	0.125	0.300	0.300	0.500
Max. possible measurement span (value at 20 mA) in [m]	2.875	5.7	9.7	14.5

Installation and Connection

14 Installation Instructions

During the installation, ensure that the following instructions regarding ESD and installation place.

- ⌚ Never operate the device without the four blue plastic cover strips.
- ⌚ Follow applicable legal or operational guidelines.

Improper handling can result in injury and/or damage to the equipment.

WARNING



Danger from electrical current

Without the four blue plastic cover strips the protection against electrical shock is not guaranteed.

Do not operate the device without the four blue plastic cover strips.

Non-observance may result in personal injuries.

14.1 Hints on how to avoid electrostatic discharge (ESD)



ESD risks

Maintenance procedures which do not require power supply of the instrument shall not be executed before the unit has been disconnected from mains power in order to minimise danger and ESD risks.

Disconnect the NivuFlow from mains power.

The sensitive electronic components inside the unit may get damaged by static electricity. The manufacturer recommends the following steps to prevent the device from getting damaged due to electrostatic discharge:

- ⌚ Discharge static electricity from your body before touching the instrument's electronic components.
- ⌚ Avoid unnecessary movements to reduce the risk of building up static electricity.

14.2 Choosing the installation place

The NivuFlow with DIN rail fastening is conceived for installation in switching cabinets.

- ⌚ Pay attention for adequate ventilation at the installation place, such as fans or heat exchangers.
- ⌚ During installation make sure that possibly existing separating devices (power switch) remain to be easily accessible.

It can be also installed in field enclosures or similar. Due to the protection degree, NivuFlow 550 is not suitable to be installed directly on site without protective measures. To do so, use the optionally available field enclosure by NIVUS.

For safe installation on the mounting place make sure to take the following precautions:

- ⌚ Protect the transmitter from direct sunlight. Install a sun shading if required.

- Observe the permissible ambient temperature.
- Do not expose the transmitter to strong vibrations or mechanical shocks.

At the mounting place always avoid:

- corrosive chemicals or gases
- radioactive radiation
- direct installation close to footpaths or travel ways

14.3 Fastening the Transmitter



Note

Mounting materials and tools are no part of the standard delivery.

- For fastening use a DIN rail type TS35 according to EN 50022 with a minimum length of 140 mm.
 1. Fasten the rail horizontally in the intended enclosure/switching cabinet by using at least two screws.
 2. Hook the transmitter into the DIN rail from below. The unit will snap in as soon as you exert slight pressure in the direction of the DIN rail.

Now you can begin to install the electric components and to connect the sensors.

15 Electric Installation

WARNING



Danger from electrical current

Disconnect the unit from mains power.

Working on electric connections may cause the risk of electric shocks. Observe electric information provided on the nameplate.

Non-observance may result in personal injuries.



Note

Observe the national installation regulations.

- Make sure to take the following precautions:
 1. Observe that the installation shall be carried out by qualified personnel only.
 2. For electric installation the local regulations in the respective countries (e. g. VDE 0100 in Germany) shall be referred to.
 3. Further statutory standards (local), regulations and technical rulings have to be taken into account.
 4. For installation in wet environments or in areas subject to flooding risk, extra protection such as by using a residual-current-operated protective device (RCD) is necessary if required.
 5. Regarding Ex protection check whether the instruments power supply needs to be integrated into the facility's emergency shut-down concept.
 6. Before feeding the rated voltage, transmitter and sensor installation must be correctly completed. Check that the installation is correct.

⇒ How to connect the sensors can be found starting at page 33, connecting the power supply is described on page 41.

15.1 Power and Relay Connections

15.1.1 Clamps for Protective Conductor Terminal and AC Supply

WARNING



Danger from electrical current

Do not operate the unit if the terminal clamp blocks above the screw flange are not tightly screwed.

The terminal block X1 (connections 15...17) for connection of the earth conductor and AC power supply is as an integral part of the device. It is no plug connection.

Non-observance may result in personal injuries.

⇒ Observe the described requirements for connection to the terminal block in chapter „18.1 Connection to the Terminal Blocks“.

15.1.2 Power supply DC

The DC version can be directly operated from the 24 V direct current network of a control cabinet.

Prerequisites

- input voltage available at the input clamps:
 - at maximum load (20 W) minimum 10 V
- clamp voltage:
 - at no-load operation maximum 35 V

15.1.3 Power supply AC

WARNING



Danger from electrical current

The power supply must be separately protected by a 6 A slow-blow fuse and has to be isolated from other facility parts separate turn-off, e. g. by using an automatic cut-out with >B< characteristics). This separator should be marked conveniently.

Non-observance may result in personal injuries.

The AC version of NivuFlow can be directly operated from the low-voltage network.

⇒ The AC power supply requirements are described in chapter „10 Specifications“.

Prerequisites

- cross-sectional dimension of the power supply wires:
 - minimum 0.75 mm²
 - according to IEC 227 or IEC 245

15.1.4 Relays

The reliability of the switching contact deteriorates if the minimum switching current is lower than specified.

- ⇒ Observe the connection and switching specifications of the relays (see chapter „10 Specifications“).

WARNING



Danger from electrical current – Measures to prevent accidental contacts

Contact protection according to the requirements as specified in EN 61010-1:2010 is not guaranteed in the event of relay voltages > 150 V due to the testing pin terminal of the relay clamp blocks.

*Take all necessary protection against electrical shock according to the laws and regulations!
For example: Open the cabinet/field enclosure only by the use of a tool or key,
or use fault-current circuit breaker or similar.
Non-observance may result in personal injuries.*

WARNING



Danger from electrical current – Protect Relay Contacts

The relay contacts of the instrument shall be protected using 6 A slow-blow fuses as soon as voltages in the low voltage range (such as AC supply voltages) are to be switched via the instrument's relay contacts. Moreover these contacts shall be designed so as to be switched off independent from other circuit parts. DC units shall be equipped with an appropriate protective earth conductor in order to avoid dangerous voltages or currents.

Non-observance may result in personal injuries.

16 Installation of sensors

This chapter describes the sensors to be used and the usual places of application. The installation of individual sensor types is described in greater detail in the according installation instructions.



Note

During mounting works ensure compliance with all regulations on safety at work.

16.1 Sensor Installation Principles

The placing of sensors within a plant is vital for the reliability of measurement results. Therefore observe proper hydraulic conditions and appropriate calming sections on the place of installation. Sensor types as well as the respective fastening methods shall be determined individually depending on the measurement place.



Conditions on how to select calming sections and the installation of sensors are described in the according installation instruction.

The parameters of the measurement place shall be set prior to installation. Information on how to prepare the measurement place as well as the according dimensions can be taken from the plant documentation.



How to set the measurement place parameters can be found in chapter „Setting Parameters“.



Note

Wetted sensors shall be installed by pipeline companies or plumbers only. The tightness of pipes shall be guaranteed in each case.

16.2 Preparations for Sensor Installation

Selecting the possible sensors



Possible sensors are listed in chapter „9.2 Connectable sensors“.

Setting the Measurement Place Parameters

Before entering sensor positions and sensor arrangement some parameters need to be edited first. Based on the data entered the transmitter will compute the sensor positions for later measurement.

The following parameters are required to set the measurement place initially:

- Sensor types used
- Canal profile
- Canal profile dimensions



The parameter setting procedure is described in chapter „Setting Parameters“.

17 Sensor Connection

17.1 Cable and cable lengths for sensor connection

Between sensor and transmitter (direct connection non Ex):

For the complete distance between the NIVUS sensors and transmitter type NivuFlow 550 use the specified cable of NIVUS:

- LiYC11Y 2x1,5 mm² + 1x2x0,34 mm² + PA

Between sensor and iXT:

Maximum cable lengths between sensors and iXT if using the NIVUS standard cable LiYC11Y 2x1.5 mm² + 1x2x0.34 mm² + PA:

- 150 metres
- Use of overvoltage protection elements
 - single-side: 135 metres
 - double-side: 120 metres



See chapter „17.3 Overvoltage Protection“.

Between iXT and transmitter (standard cable):

Maximum cable lengths between transmitter and iXT if using the NIVUS standard cable LiYC11Y 2x1.5 mm² + 1x2x0.34 mm² + PA:

- 50 metres
- Use of overvoltage protection elements:
 - no influence

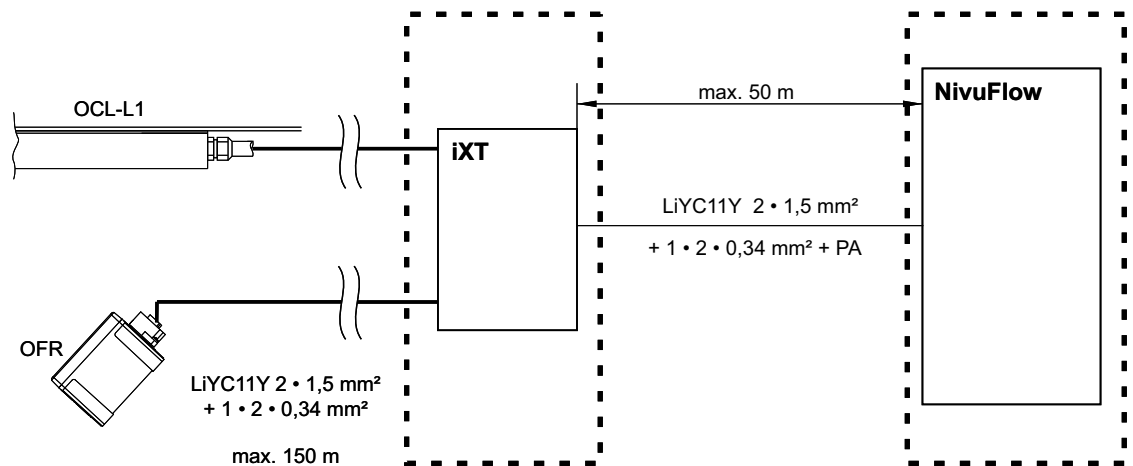

Fig. 17-1 Connecting Ex-separation interface iXT to NivuFlow via standard cable

Between iXT and transmitter (telecommunications cable):

Maximum cable lengths between iXT and transmitter if using a Type A2Y(L)2Y 10x2x0.5 mm² telephone cable:

- 250 metres

To do so, nine wires for power supply and GND each are combined. One wire pair is used for RS485 communication.

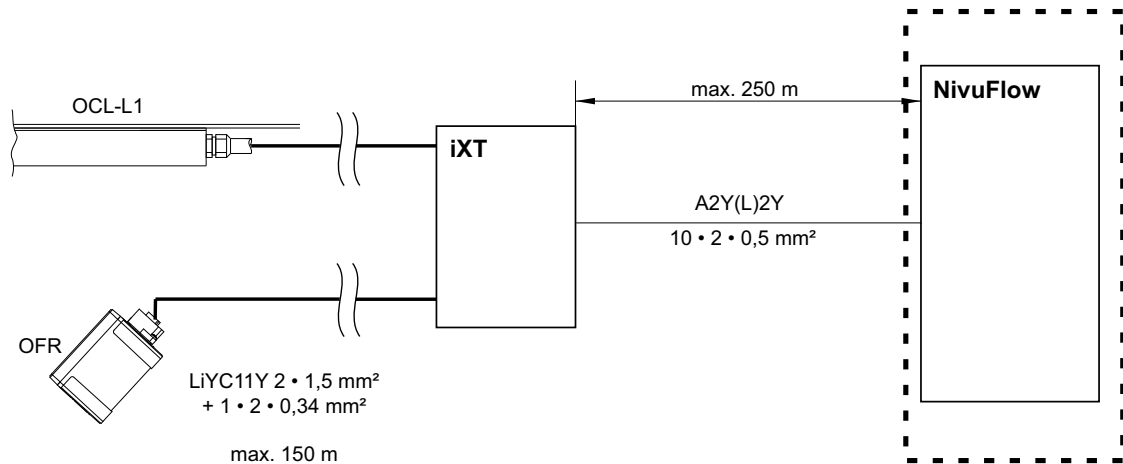

Fig. 17-2 Connecting iXT to NivuFlow via telecommunications cable

The signal cable is not suitable for direct and permanent installation in ground. Use protective tubes or protective hoses with appropriate inner diameters if the signal cable is to be installed in ground, concrete or similar.

17.2 Sensor Connection at NivuFlow



Sensor wiring diagrams can be found in the according Technical Description or Instruction Manual.

The connected sensors are used to

- determine the flow velocity:
 - using the connected flow velocity sensors
- Level determination:
 - using the connected level sensors
 - via Modbus
 - by defining a fixed value

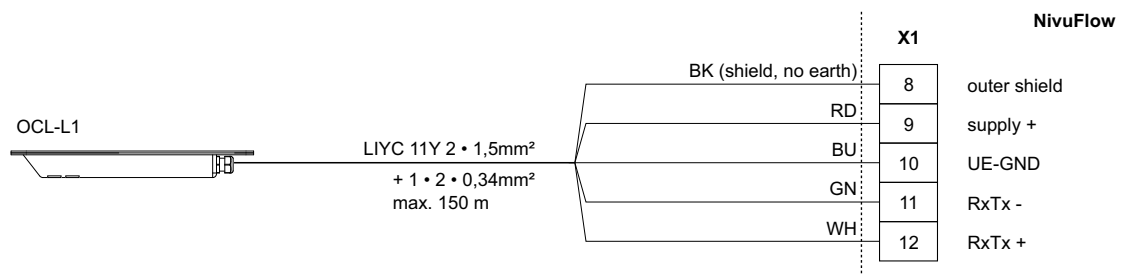

Fig. 17-3 Connection air ultrasonic sensor, type OCL-L1

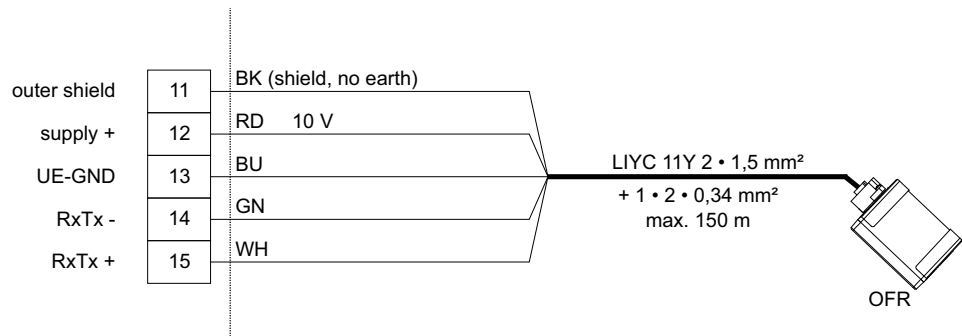

Fig. 17-4 Connection radar sensor, type OFR

Level via 2-wire sensor

The level measurement can also be carried out by a 2-wire sensor (NivuBar, NivuCompact 2-wire echo sounder or similar) which is supplied by the NivuFlow.

- ➡ Connect the 2-wire sensor according to Fig. 17-5.

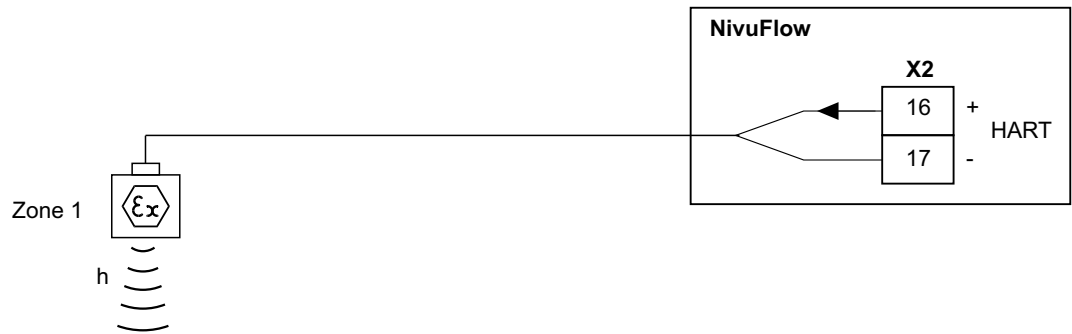

Fig. 17-5 Connecting a 2-wire sensor EX for level measurement

- ➡ If the mA signal of the level measurement is provided from an external transmitter (e. g. NivuMaster), the transmitter must be connected according to Fig. 17-6.

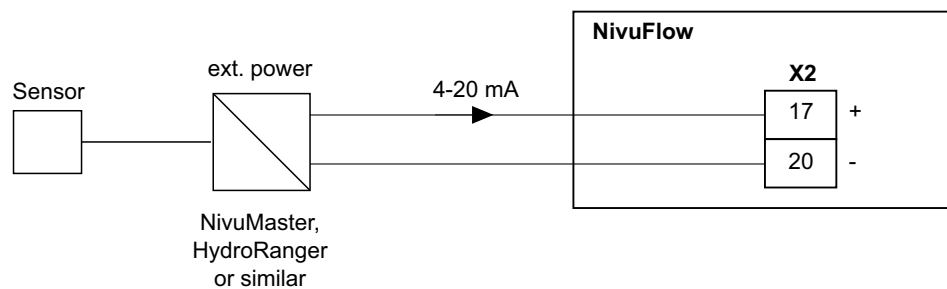

Fig. 17-6 Connecting an external transmitter

17.3 Overvoltage Protection

For effective protection of the NivuFlow transmitter it is necessary to protect power supply as well as mA-output using overvoltage protection devices.

NIVUS recommends surge arrestors types EnerPro 220Tr, EnerPro 24Tr (for 24 V DC) for the mains supply, as well type DataPro 2x1 24/24Tr for mA-inputs and mA-outputs.

The flow velocity sensor as well as the air-ultrasonic sensor type OCL-L1 are internally protected against overvoltage. If higher voltages are expected to occur they can be protected by combining the types DataPro 2x1 12/12-11µH-Tr (N) as well as SonicPro 3x1 24 V/24 V.



Important Note

If using the sensors in Ex areas consider the connected loads of the overvoltage protection devices as well as capacity and inductance of the NIVUS sensor cables (OCL-L1) additionally!

The maximum permissible NIVUS cable lengths in Ex areas are:

- *single-side overvoltage protection: 135 m (443 ft.)*
- *double-side overvoltage protection: 120 m (394 ft.).*



Note

The line resistance is 0.3 Ohm/wire. This resistance must be taken into account considering the allowed total resistance (see "Technical Instructions" and/or "Instruction Manuals" of the sensors for details).



Observe the non-reversed connection (p-side to transmitter) as well as a correct, straight wiring supply.

Ground (earth) must lead to the unprotected side.

The overvoltage protection devices are ineffective if wired incorrectly.

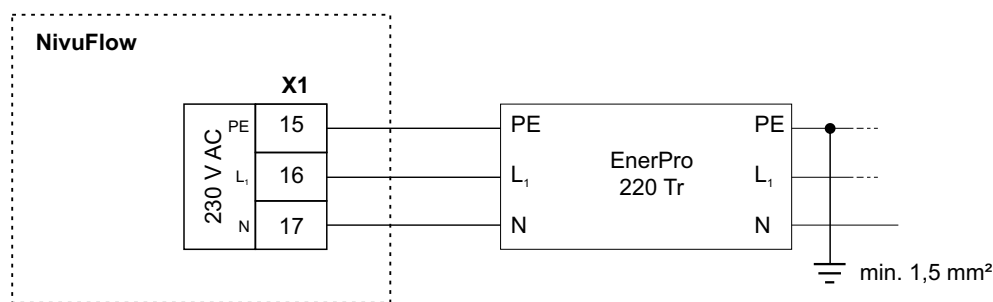

Fig. 17-7 Overvoltage protection for power supply AC

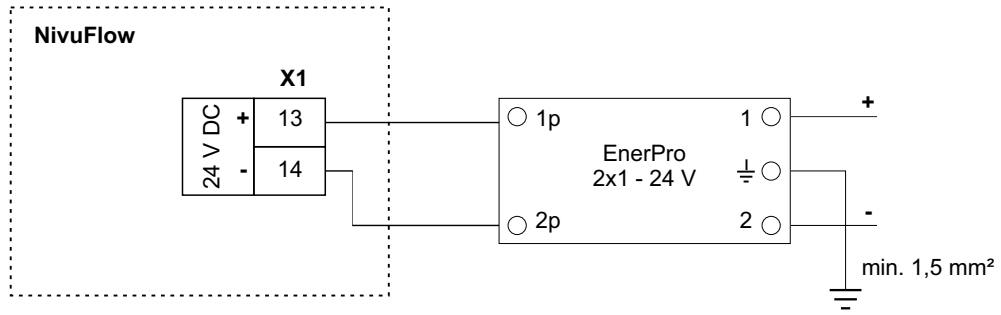

Fig. 17-8 Overvoltage protection for power supply DC

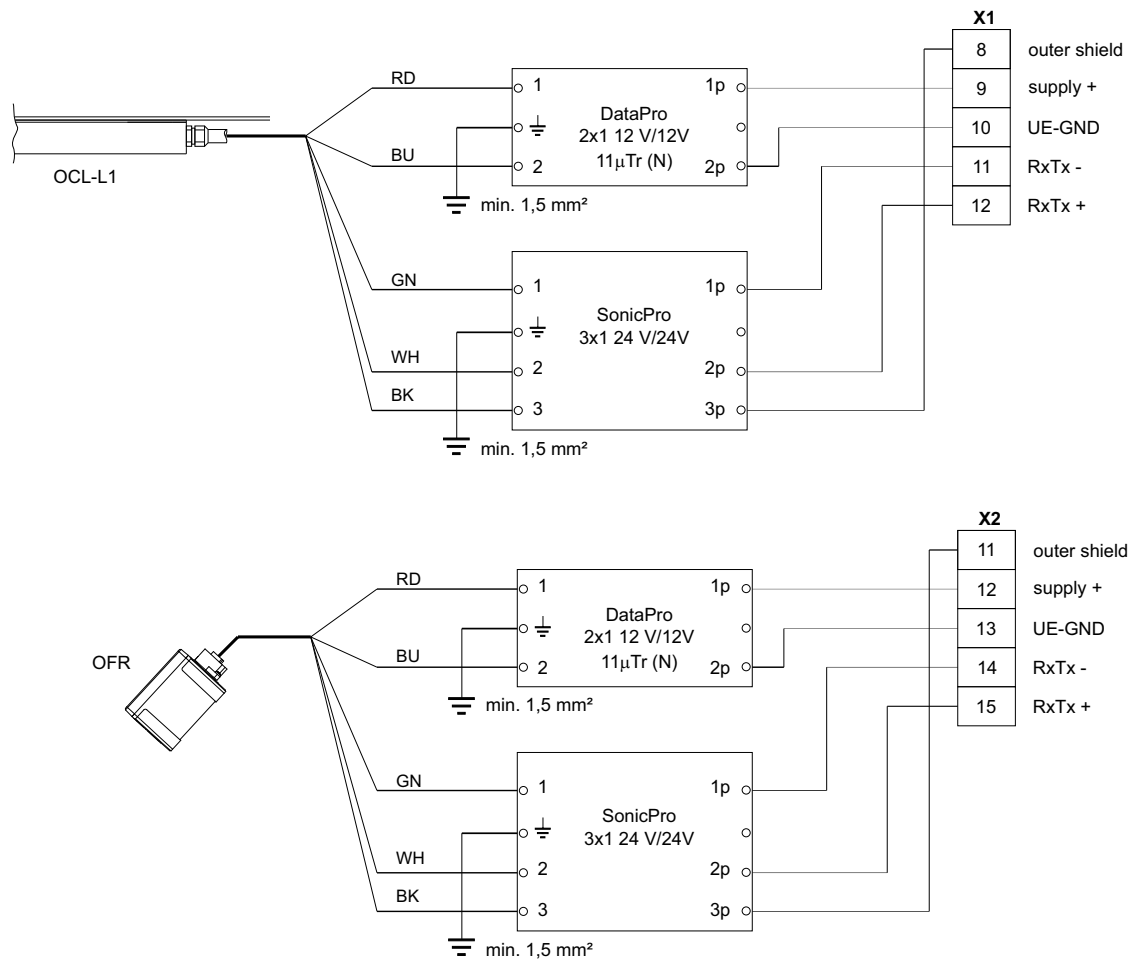

Fig. 17-9 Sensor overvoltage protection for R1

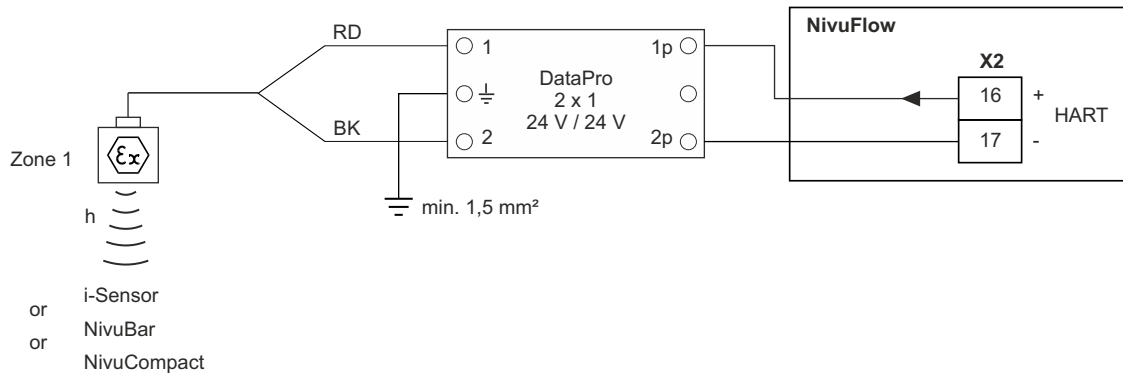

Fig. 17-10 Overvoltage protection external level measurement

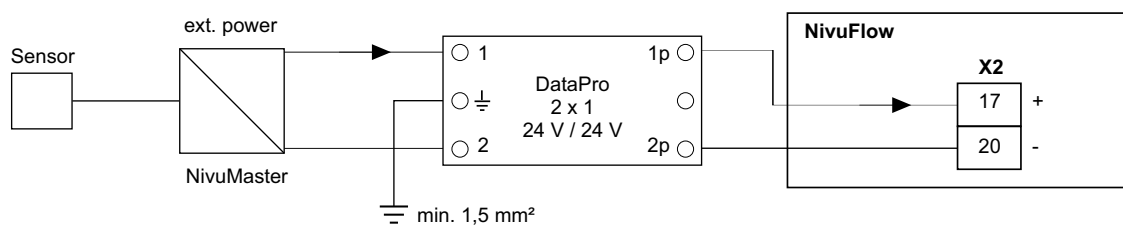

Fig. 17-11 Overvoltage protection of 4 ... 20 mA input from external transmitter

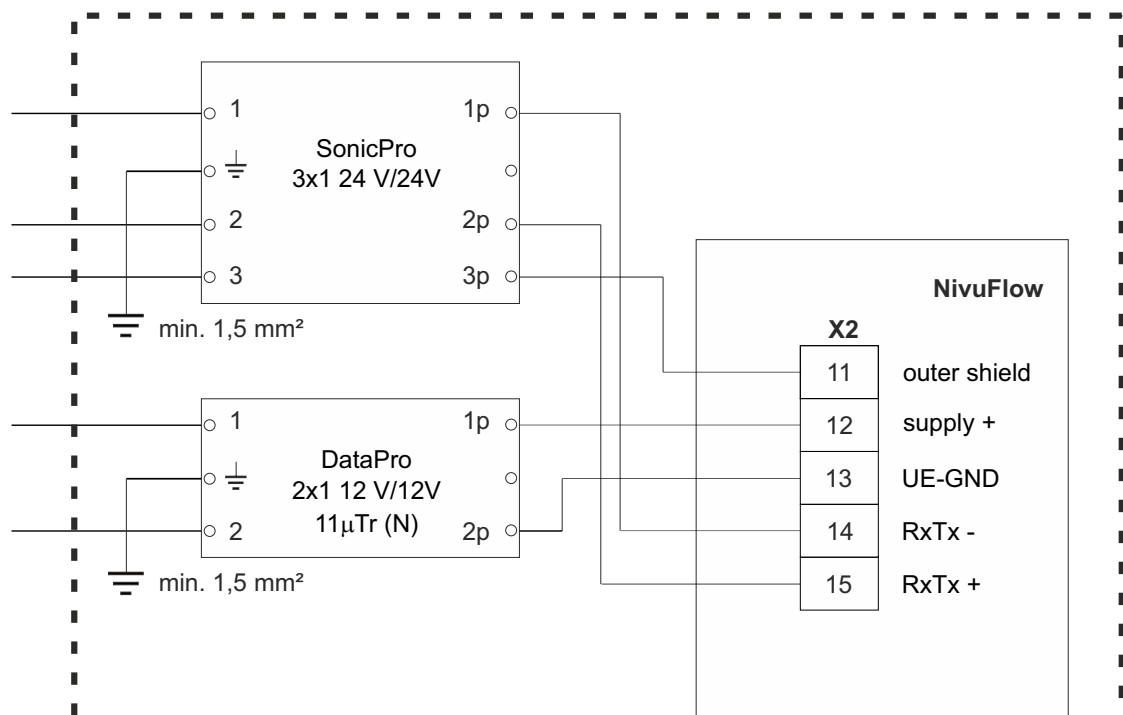

Fig. 17-12 Overvoltage protection iXT to NivuFlow 550



Note

- The minimum wire cross section is 1.5 mm² (not for strands).
- The maximum permissible cable length is 1 m.

18 Transmitter Connection

18.1 Connection to the Terminal Blocks

All NivuFlow transmitters are equipped with push-in tension clamp terminals. The use of these push-in tension clamp terminals enables an easy pre-installation of the transmitter.

This allows verifying individual sensors, input and output signals etc. as well as easy transmitter replacement if required.

The tension clamp terminal blocks are suitable for the connection of single-wire and multiple wire copper cables. These cables are vibration-proof.

- ➡ To open the contacts on the tension clamp terminal blocks, use gentle pressure with a slot screwdriver on the front-side orange elements.

To connect the power supply push-in and screw-type tension clamp terminal blocks are used.

To connect the power supply, use a slot screwdriver with a blade width of 3.0 or 3.5 mm.



Important Note

Unplug and connect the tension clamp terminal blocks only in de-energised condition disconnected from mains power.

WARNING



Risk of electric shock

Multiple wire cables (strands) of the AC power supply circuit as well as of relay connections shall be equipped with ferrules featuring an isolated protective collar (plastic ferrule) to avoid danger due to several protruding wires.

Non-observance may result in personal injuries.

Tension clamp terminal block	Power supply	Bus/ Network	Terminals O/I etc.	Air-US-sensor OCL-L1
wire cross section, rigid cables in [mm ²]	0.2 ... 2.5	0.2 ... 0.5	0.14 ... 1.5	0.2 ... 2.5
wire cross section, flexible cable in [mm ²]	only DC: 0.2 ... 2.5	0.2 ... 0.5	0.14 ... 1.5	0.2 ... 2.5
wire cross section flexible with ferrule blank in [mm ²]	only DC: 0.25 ... 2.5	0.25 ... 0.5	0.25 ... 1.5	0.25 ... 2.5
wire cross section flexible with ferrule with plastic sleeve in [mm ²]	0.25 ... 2.5	undefined	0.25 ... 0.5	0.25 ... 2.5

18.1.1 Connection Diagrams

WARNING



Risk of electric shock

Do not remove the tension clamp terminal block from board X1 (connections 15...17). This tension clamp terminal block is to connect the protective conductor as well as the AC power supply and is an integral part of the instrument. Operate the instrument with the tension clamp terminal block screwed on only. Non-observance may result in personal injuries.

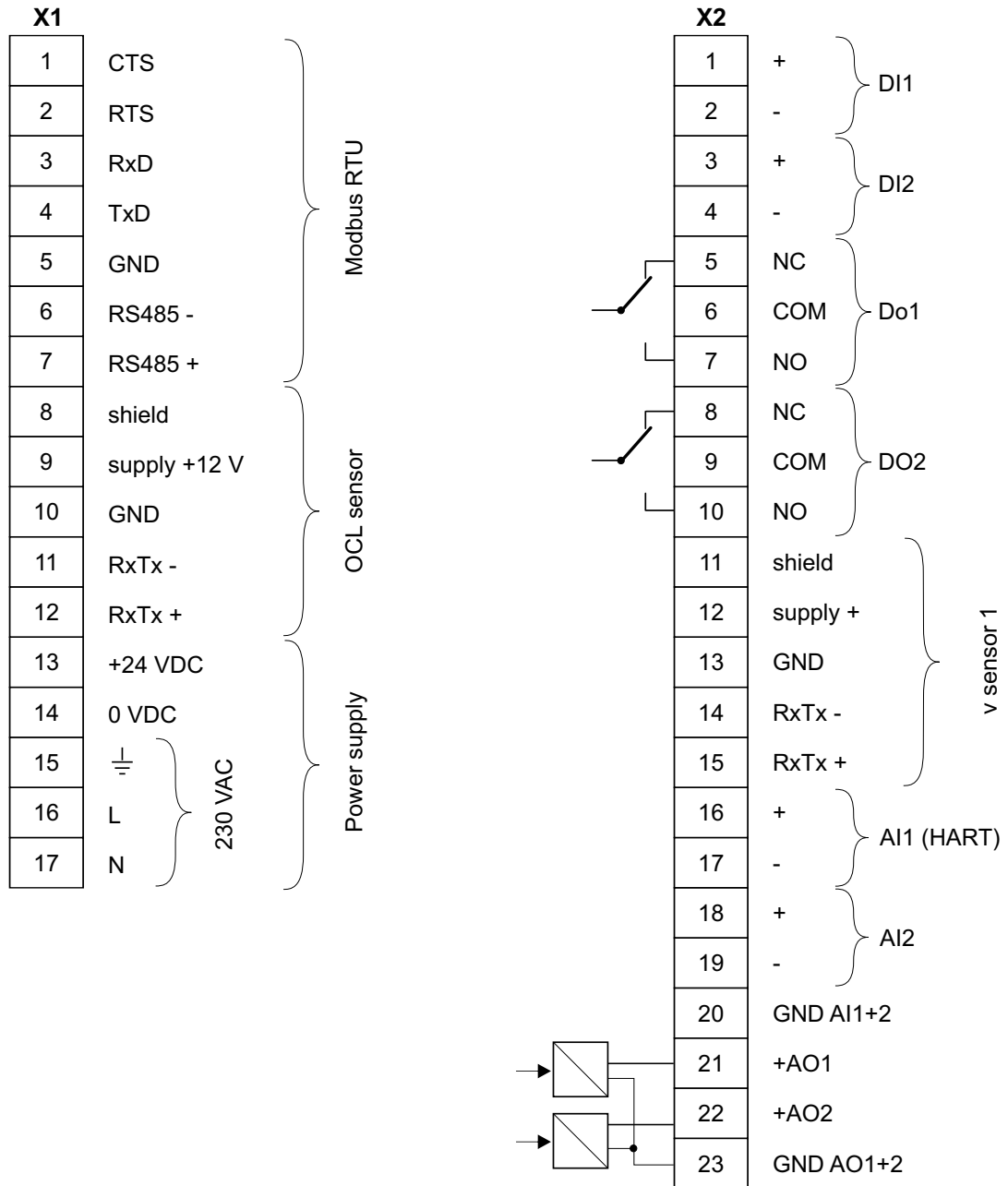
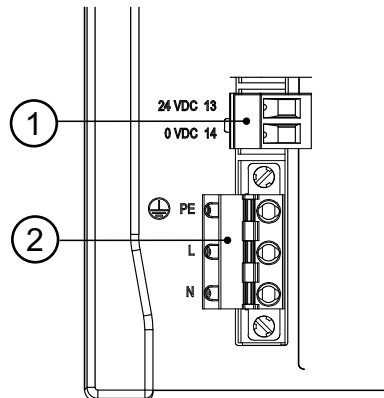

Fig. 18-1 General connection diagram - NivuFlow 550, type R1

18.2 Switching on voltage supply

Depending on the type of NivuFlow 550 used the unit can be powered with 100...240 V AC (-15 / +10 %) or with 10...35 V DC.



- 1 24 V DC connection
- 2 230 V AC connection

Fig. 18-2 Electrical Connections of power supply NivuFlow

WARNING



Risk of electric shock

Do not remove the tension clamp terminal block from board X1 (connections 15...17). This tension clamp terminal block is to connect the protective conductor as well as the AC power supply and is an integral part of the instrument. Operate the instrument with the tension clamp terminal block screwed on only. Non-observance may result in personal injuries.



Important Note

A transmitter with 24 V DC cannot be operated with alternating current. Further, it is not possible to operate a 230 V AC transmitter with 24 V direct current.



Note

The line resistance is 0.3 Ohm/wire. This resistance must be taken into account considering the allowed total resistance (see "Technical Instructions" and/or "Instruction Manuals" of the sensors for details).

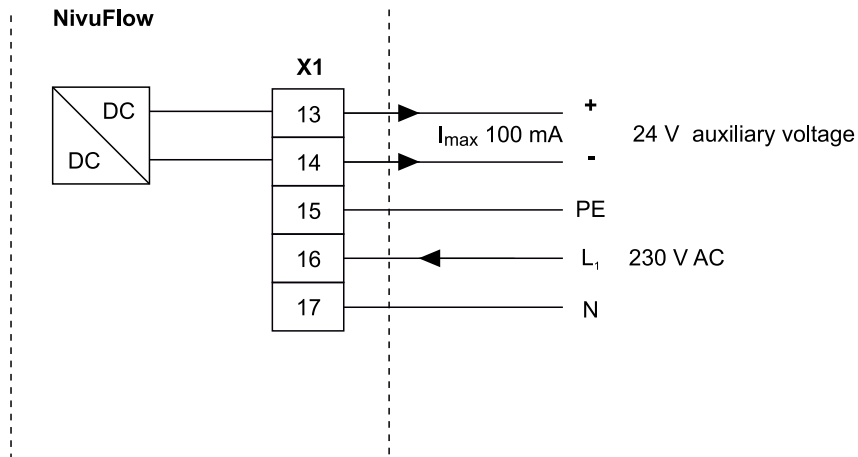

Fig. 18-3 230 V AC connections of power supply

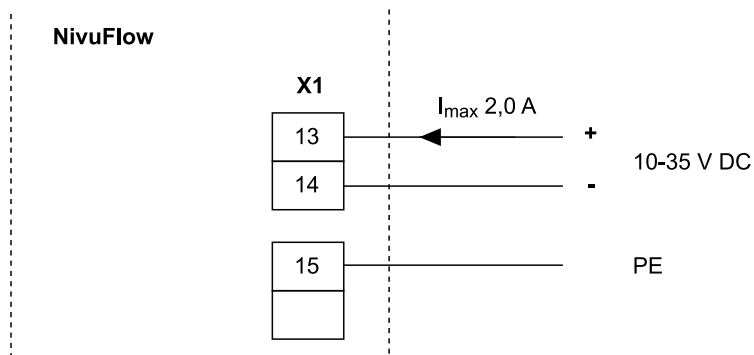

Fig. 18-4 DC connections of power supply

Operation start-up

19 Notes to users

Before connecting and operating the NivuFlow the instructions below shall be followed.

This instruction manual contains all information required for the setting of parameters and for the use of the instrument. The manual is intended for qualified personnel.

Appropriate knowledge in the areas of measurement systems, automation technology, control engineering, information technology and wastewater hydraulics are preconditions for putting the NivuFlow into operation.

Read this instruction manual carefully in order to guarantee proper function of the NivuFlow. The NivuFlow shall be wired according to the wiring diagram in chapter „18.1.1 Connection Diagrams“.

In case of doubt regarding installation, connection or the setting of parameters contact our hotline:

- +49 (0) 7262 9191-955

General principles

The system shall not be put into operation before the installation has been finished and checked.

Follow the hints in the instruction manual to eliminate the risk of faulty or incorrect setting of parameters. Before you begin to set parameters, get familiar with the transmitter operation using entry wheel, function keys and display.

The connection of transmitters and sensors (according to chapter „14 Installation Instructions“ and „17 Sensor Connection“) followed by the setting of the measurement place parameters.

In most cases it is sufficient to set:

- shapes and dimensions of the measurement place
- sensors used and the according positions
- display units
- span and function of analog and digital outputs

The user surface of the NivuFlow is easy to understand. Users can make all required **basic settings** themselves.

In case of the following requirements let either the manufacturer or an expert company authorised by the manufacturer set the parameters:

- Extensive programming tasks
- Difficult hydraulic conditions
- Special channel shapes
- If the service specification requires a protocol on settings and errors

20 Operation Basics

The complete operation of the NivuFlow is handled via control elements (see chapter „2.2 NivuFlow control elements“). Two control buttons and one rotary pushbutton are available for the setting of parameters and to input required data.

The display at any time provides information on where you currently are within the menu structure and which entries you are about to modify.

20.1 Display Overview

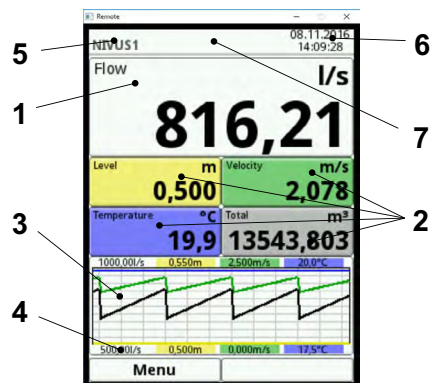

- 1 Display area 1 (Output field 1)
- 2 Display area 2 (Output fields 2...5)
- 3 Display area 3
- 4 Functions
- 5 Name of measurement place
- 6 Date/time
- 7 Error message sent or display for active service mode

Fig. 20-1 Display overview

20.2 Using the Control elements

➡ First, select the >main menu<. Press the right hand function key.

1. Turn the rotary pushbutton to scroll through the menu. A sub-menu can be selected, as soon as it is highlighted blue.
2. Press the black part of the rotary pushbutton - you will get to the next parameter level or you can enter parameter settings.

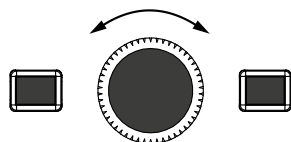

3. Repeat this process until you arrived at the desired menu or parameter.

Here you can enter names or numbers in parameters.

➡ See chapter „20.3 Use/Entry using the letter block“ and „20.4 Use/Entry using the numeric keypad“.

Press the left hand function key to exit the menus step by step.

The transmitter in the background operates with the settings which have been entered at the beginning of the parameter setting.

The following request is prompted on the display not before the current parameter setting has been finished and confirmed.



Fig. 20-2 Confirmation after parameter setting

➡ Confirm the entry with >YES<.

The password query for the parameter settings appears:



Fig. 20-3 Password query for parameter settings

➡ Enter the password (default setting "2718").

After accepting the new parameters the NivuFlow continues to operate using these data.

20.3 Use/Entry using the letter block

Certain parameters can be labelled with names or designations. A virtual keypad is indicated in the bottom section of the display if such a parameter has been selected.

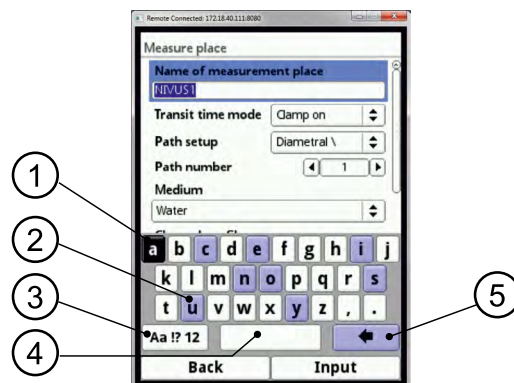

- 1 Selected character
- 2 Dual function character
- 3 Shift (upper/lower case)
- 4 Space
- 5 Back or delete button

Fig. 20-4 Keypad



Note

The use of the key pad is explained here one-time. Later in the manual you will be prompted to enter designations or names following this explanation.

A shift key can be found at the bottom left of the keypad (Fig. 20-4 no. 3).

- The functions of the shift key are:
 - Upper case
 - Lower case
 - Special characters
 - Digits
- This settings allow individual names of the measuring place almost without limitations.
- To **activate** this shift key rotate the rotary pushbutton until the shift key is highlighted black.



To **enter** designations such as the measurement place name proceed as follows:

1. Turn the rotary pushbutton to scroll to the lower half of the display. A virtual keypad featuring individually selectable letters is indicated.
2. Turn the rotary pushbutton to navigate through the virtual keypad. Characters highlighted blue (Fig. 20-4 no. 2) feature dual functions. Holding the button depressed for approx. 1 sec. switches over to alternative function.
3. Press the rotary pushbutton until the desired character is highlighted black. By pressing the character is applied to the text box automatically.
4. Repeat this process until the complete name is on the display.

20.4 Use/Entry using the numeric keypad

In certain parameters it is possible to enter dimensions or other numeric values. A number field (analogous to letter block) is indicated in the bottom section of the display if such a parameter has been selected.



Note

The use of the numeric key pad is explained here one-time. Later in the manual you will be prompted to enter dimensions or numerical values following this explanation.



Press the rotary pushbutton - a numeric field will appear:

1. Enter the values digit by digit. Proceed the same way as described before in the keypad section.
When entering the dimensions observe the correct decimal places. The channel profile dimension e. g. is set to METER per default.

If **multiple dimensions shall be entered consecutively** (e. g. for rectangular profiles), you can get to the next dimension by rotating the rotary pushbutton after your former entry has been confirmed. For the next entry proceed right as described before.

20.5 Revision of parameters

- ➡ Incorrect entry can be deleted letter by letter or digit by digit by pressing the back button:
 1. Open the keypad.
 2. Turn the rotary pushbutton until you get to the >back arrow< (back button).
 3. Press the rotary pushbutton - this will erase the wrong letter or number.
- ➡ Write subsequently until the complete name or dimension appears in the display and confirm the entry with the right hand function key.

The name of measurement or the numerical value is taken to the main menu and is displayed there.

20.6 Menus

All menus are described in a logical programming order in chapter „Setting Parameters“. There are six basic menus available which can be viewed and selected by pressing the right hand function key.

The menus are:

Application	It guides the commissioning personnel through the entire setting of parameters for the dimensions of measurement places, selection of sensors and analog and digital inputs and outputs
Data	<ul style="list-style-type: none"> - visually indicate charts on flow rate, level and average flow velocity - visually indicate tables on 24-hour day totals - save data - save and load parameters - format USB stick - modify storage cycles and totals
System	<ul style="list-style-type: none"> - recall basic information on the transmitter such as serial no., version, article no. and many more (needed in the event of queries from the manufacturer) - settings such as language, time and data format can be modified in the >country settings< - system time and time zones can be found in the >Time/Date< sub-menu - error messages are available in the according sub-menu - service level is not described in more detail here
Communication	This menu contains parameters for all communication interfaces available on the NivuFlow
Display	<ul style="list-style-type: none"> - basic parameters such as contrast, backlight and display dimming can be adjusted here - format of the output fields (text, decimal places...) can be set
Connections	Possible connections for Ex-Separator Module

Setting Parameters

21 General Programming

As a principle modified parameters will not become effective before they have been saved. The transmitter will verify whether parameters have been modified while exiting any menu. Subsequently you will be prompted to decide if you wish to save the modified parameters.

- >Yes<: the modification will be accepted and saved.
- >No<: the modification will be rejected and the menu is exited.
- >Cancel<: You are exiting the prompt. Parameters remain to be modified but will not become effective and will not be saved, however.

21.1 Save Parameters

If you wish to accept and to save parameters you need to enter a valid password first.

Default setting: 2718

21.2 Change Password



See also chapter „25.5.1 Change (System) Password“.

You can change the default password at any time. However, keep in mind that a modified password will secure any modifications of the transmitter settings. Here the password length is limited to a maximum of ten characters.



Procedure to change the password:

1. First open the >System< menu.
2. Select >Service< submenu.
3. Activate the field >Change Password<.
4. Use the number field to enter the current password.
5. Then enter the new password (ten characters max.).
The transmitter will accept the new password securing all transmitter settings.



Important Note

*Share your password with authorised persons only!
If you should write down your password store it in a safe place. Should your password get lost contact the manufacturer.*

22 Parameter Functions

22.1 Main Menu

The transmitter parameters can be set using a total of six setup menus within the first menu level. Individual menus and the according submenus are explained in greater detail starting in chapter „23 Description of Parameters“.

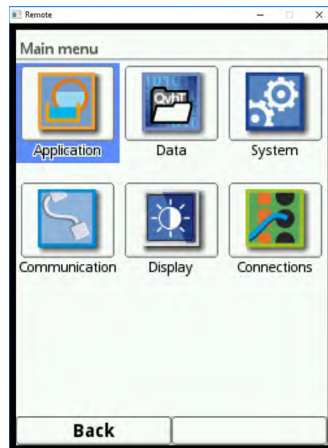

Fig. 22-1 Overview main menu



While setting parameters observe chapter „20 Operation Basics“.

22.2 Functions Top Menu Level

22.2.1 Application Menu

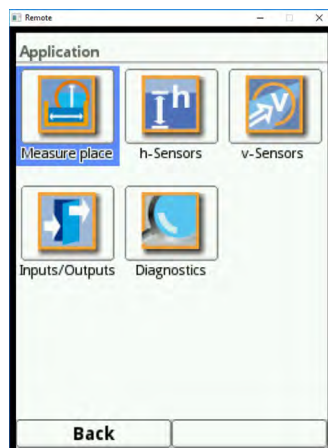

Fig. 22-2 Application Menu

This menu is the most extensive and most relevant when it comes to set the transmitter parameters. The >Application< menu contains five submenus. This is where shape and dimensions of the measurement site are to be set. The flow velocity sensors used as well as information on the mounting position are specified here.

Moreover the required analogue and digital inputs and outputs are defined here:

- Functions
- Measurement ranges
- Measurement spans
- Limit values

Within this menu diagnostic options for the items below are available:

- Sensors
- Inputs and outputs
- Overall system

The diagnostic options are explained in chapter „Diagnosis“ starting at page 109.

The following parameters can be set or modified in the >Application< menu:

- Constant, fixed sludge levels
- Flow velocity evaluation (radar)
- Low-flow suppression
- Damping of signal evaluation and output
- Stability of signal evaluation and output

22.2.2 Data Menu

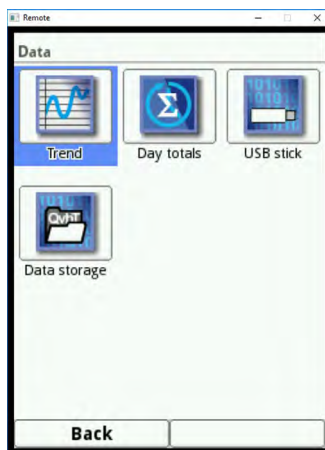

Fig. 22-3 Data Menu

The >Data< menu allows accessing all measurement values in the internal memory. The functions below are available:

- Graphic representation of measurement values
- List of the 100 previous 24h-day totals
- Communication and transmitting options of internal files
- Format external USB stick
- Transmission of parameters set from USB stick and back
- Options to set and to erase the internal data memory
- Setting the storage cycle

22.2.3 System Menu

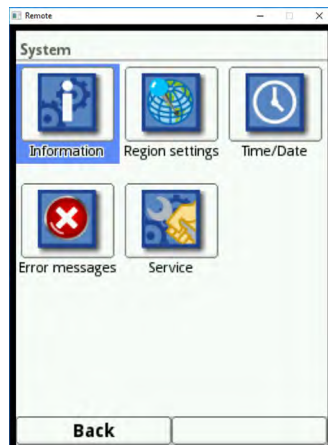

Fig. 22-4 System Menu

The >System< menu contains information on the transmitter:

- Article No.
- Firmware version
- Serial No.

Furthermore the settings/adjustments below are available:

- Set language
- Set units
- Adjust date and time
- Read active error messages
- Erase error memory
- Change password
- Restart (system or measurement)
- Parameter reset

22.2.4 Communication Menu



Fig. 22-5 Communication menu

This menu comprises the settings for the communication of various communication interfaces with other communication systems:

- TCP/IP
- Web server (in preparation)
- HART (in preparation)
- Modbus

22.2.5 Display Menu

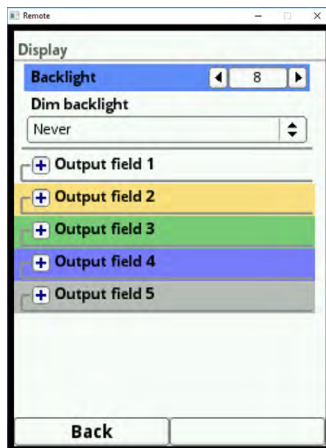

Fig. 22-6 Display Menu

This menu permits to adjust the backlight settings as well as to adjust the settings of the five output fields of the main screen, if required.

22.2.6 Connections Menu



Fig. 22-7 Connections Menu

This is where the connection of the transmitter to the iXT intelligent Ex separation module needs to be entered.

23 Description of Parameters

23.1 Setting the Measurement Place Parameters (Application Menu)

The >Measurement Place< submenu is one of the most important basic menus when it comes to parameter setting. The following basic settings are required to set the parameters of the measurement place:

- Name of measurement place
- Type and dimensions of canal profile
- Measurement medium and pipe material
- Possibly fixed settings on sedimentation
- Flow velocity evaluation based on the measurement method
- Low-flow suppression
- Measurement damping and stability

23.1.1 Name of Measurement Place



Fig. 23-1 Entering the name of the measurement place

This is the place to enter the desired name of the measurement place. The name space is limited to 256 digits.

Default setting of the name: NIVUS1.

When entering a new name the default name will be erased automatically as soon as the first letter or the first number is selected.

➡ Procedure:

1. Enter the name of the measurement place completely into the text field using the keypad.
2. Confirm the name by using the right function key "Enter". The name of the measurement place is accepted and will be indicated in the main menu.

23.1.2 Channel Profiles

The transmitter provides a great number of standard canal profiles mainly used in practice to choose from.

Since special shapes can be found particularly in older channel systems the transmitter moreover allows entering the dimensions of symmetric and asymmetric channels specifying height/area figures into a table.

Selecting the 3D preview will indicate the chosen profile graphically. The graphic representation shows the dimensional information entered in the correct proportions.

This visible aid permits to verify whether the profile has been created correctly in principle. This kind of direct verification is helpful particularly with free profiles.



Fig. 23-2 Selectable channel profiles

- Select from the available channel profiles:
 - Pipe
 - Ellipsoid
 - Egg (1:1.5)
 - Rectangular
 - U-Profile
 - Trapezoid
 - Water bed
 - Height-Width (symmetric)
 - Height-Width (asymmetric)
 - Height-Area
 - $Q=f(h)$

- After selecting the profile enter the dimensions digit by digit. Observe the units (decimal places).
Default setting: channel profile dimensions in METER.

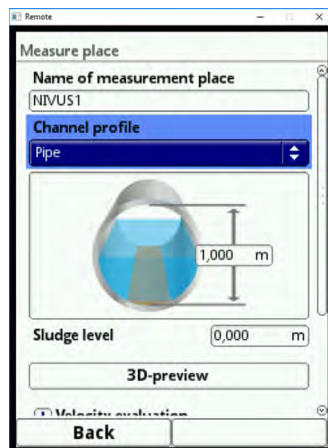

Fig. 23-3 Example of a channel profile menu

Pipe

This shape is suitable for round pipes. The selection can be used for half shells featuring a filling level of 50 % as well.

Deformed pipes featuring an asymmetric height/width ratio can be set using the ellipsoid shape.

For U-profiles there is a dedicated profile selection available.

Ellipsoid

The ellipsoid profile is preferably used for pipes exposed to mechanical stress (lateral pressure or crown pressure). There are also special channel shapes known as ellipsoid profiles.



Note

Do not mistake the horizontally and vertically symmetrical ellipsoid profile with the egg profile. Egg profiles feature different radii on the bottom and in the crown and thus are only symmetrical in a vertical sense.

➡ Enter both dimensions of the ellipsoid profile.

Egg Profile (1:1.5)

This shape represents a "standard egg" according to German DWA A 110 featuring a width/height ratio of 1:1.5. Parameters for squeezed or compressed egg-shaped profiles must be specified using the free profile option.

While setting the parameters for a "standard egg" profile all you need to specify is the maximum channel width. The transmitter automatically calculates the height by using the fixed 1:1.5 relation.

Rectangular

This profile selection is used to set the parameters for canals with vertical walls and a horizontal bottom. The parameters can be set easily by simply entering width and height of the channel.

This menu features an extra option to set the parameters for a channel with a centre dry weather flume.

- **Rectangular with Dry Weather Flume**

➤ Procedure:

1. Select the dry weather flume.
2. Tick >Active<.
3. Two more input fields will open.
4. Specify height and diameter of the dry weather flume.
5. Use the 3D view to check the dimensions input.

U-Profile

The U-profile consists of a bottom semicircle and vertical walls. The radius of the semicircle here is 0.5x channel width and will be included for calculation by the system automatically. Profiles featuring radii > 0.5x channel width must be set as free profiles.

Trapezoid

This selection permits to set parameters for symmetric channels with horizontal bottom and slanted side walls. The parameters for symmetric channels with horizontal bottom, slanted side walls and vertical walls on the top can be set here as well.

This menu too allows setting parameters of a channel with centre dry weather flume.

- **Trapezoid channel with dry weather flume**

- Proceed as described under the rectangular channel with dry weather flume on page 56.

Water Bed



Note

Programming water bed parameters requires thorough knowledge and experience in operating the NivuFlow 550 as well as in hydrological conditions.

We recommend programming to be implemented by the NIVUS commissioning service or an expert company authorised by NIVUS.

For this profile the reference point/zero point must be defined by the user. Mostly the maximum filling level or the water surface on one side of a bank or a canal is determined as zero point. Use local measurements to specify the water profile for a certain section in the transmitter.

- Enter the freely defined measuring sections into the table successively.

Symmetric Profile with Height-Width (Height-Width (sym.))

This menu can be used to set any symmetric profile.

After selecting the >Table< a value table will be shown. This table allows entering a maximum of 32 breakpoint pairs (channel height/channel width). The system calculates these values automatically and saves the results internally as symmetric profile.

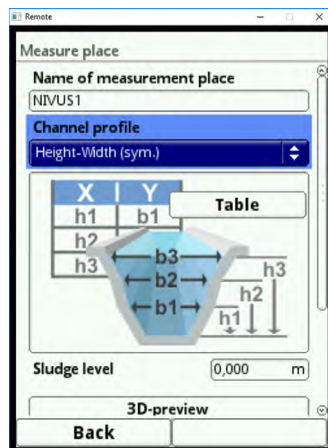

Fig. 23-4 Profile Parameters with Height-Width (sym.)



Note

A scale drawing is required to set the parameters of the channel.

➡ Procedure:

1. Draw a vertical auxiliary line through the channel centre on the scale drawing.
2. Draw horizontal auxiliary lines through the distinctive points where the profile changes.
3. Measure the length of the auxiliary lines and convert the lengths true to scale.
4. Start at level "0" to define the start of the canal.
5. Enter all other breakpoints "free" in terms of height and width.
The distance between the individual height points may vary. To define the profile it is not really necessary to specify all 32 breakpoints since the transmitter will linearise the distance in between.
In case of large irregular variations of the channel dimensions use lower distances between the breakpoints within this section.
After the channel parameters have been set completely the entered values will be indicated proportional to each other graphically.
6. Use the 3D view to verify the dimension settings. This visual aid helps to identify major programming mismatches.

Free asymmetric Profile with Height-Width (Height-Width (asym.))

In daily practice from time to time asymmetric profiles featuring unusual shapes can be found. For such cases the programming option for asymmetric profiles can be used.



Important Note on the viewing direction for free Profiles

The viewing direction >Width left< or >Width right< is against the flow direction in the channel.



Note

A scale drawing is required to set the channel parameters.

➤ Procedure:

1. Draw a vertical auxiliary line from the lowest point of the channel to the top on the scale drawing.
2. Use this line as start to draw horizontal auxiliary lines through the distinctive points where the profile changes to the left and to the right.
3. Measure the distance of these lines from the centre line to the points left and right.
4. Convert the breakpoints true to scale and enter the values into the three columns of the value table as follows: height / width to the left / width to the right.
Be sure to observe the important hint on the **Viewing Direction** for free profiles on page 57.
5. Start at level "0" to define the start of the canal.
6. Enter all other breakpoints "free" in terms of height and width.
The distance between the individual height points may vary. To define the profile it is not really necessary to specify all 32 breakpoints since the transmitter will linearise the distance in between.
In case of large irregular variations of the channel dimensions use lower distances between the breakpoints within this section.
After the channel parameters have been set completely the entered values will be indicated proportional to each other graphically.
7. Use the 3D view to verify the dimension settings. This visual aid helps to identify major programming mismatches.

Free symmetric Profile with Height-Area (Height-Area)

Some hydraulic tables contain height-area value pairs for symmetric channels instead of height-width. In such a case enter the according value pairs into the selected height-area table.

Be sure to observe the important hint on the Viewing Direction for free profiles on page 57.

Proceed right as described in the settings for height-width profiles. Only a graphical representation of the programmed profile is not available here.

Q/h-Function ($Q=f(h)$)

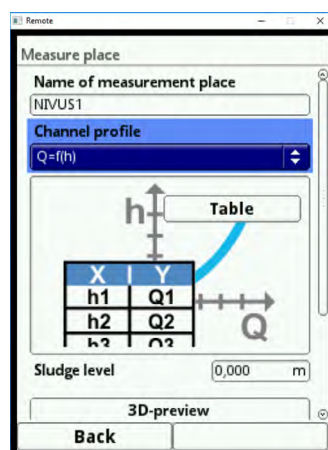

Fig. 23-5 Q/h-Function

This function is substantially different from the channel profiles described above. Neither the channel profile nor the flow velocity is taken into account here. **Communication** to possibly connected flow velocity sensors will **be shut down**. This is why possible error diagnostics are not going to consider the missing flow velocity value.

The system utilises a pure Q/h-function. This means that a defined flow value is indicated depending on the currently measured level. The value is entered into a level-dependent value table.

A maximum of 32 level-dependent breakpoints can be entered into this table. The transmitter linearises between the individual breakpoints.

23.1.3 Sludge Level

In horizontal pipelines sedimentation may possibly occur on the channel bottom depending on measurement medium and the flow velocity.

This parameter can be used to specify a fixed level of sedimentation within the pipe as >Sludge Level<. The specified sludge level is calculated as "non-movable, partial surface of the channel with horizontal surface located on the bottom". This level will be subtracted from the wetted total hydraulic area prior to flow calculation.

23.1.4 Flow Velocity Evaluation

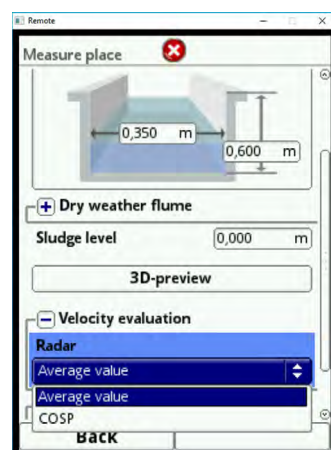

Fig. 23-6 Selection options

Radar:

- Average value
- COSP

Default setting: "COSP".

NIVUS strongly recommends to maintain the setting since it provides the most accurate results.

Remarks on Options

- **COSP:**
COSP denotes a correction factor for flow measurements and considers the channel parameters set as well as the resulting changes of the flow behaviour.

23.1.5 Low-Flow Suppression

This parameter is to suppress very low movements or apparent flow volumes. The main area of use is the measurement of discharge volumes in permanently filled structures.

☛ Tick >Active<.

One more input option opens. Enter here the positive value you wish to suppress in case of lowest discharge. It is not possible to enter negative values here.

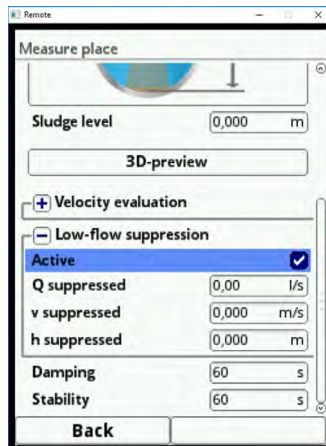

Fig. 23-7 Low-flow suppression

The low-flow suppression prevents the detection of lowest velocity changes. Over a long period such changes may cause high apparent fluctuations of the measured volumes.

Flow velocities lower than the value set above will be "suppressed" and hence are not detected as flow volumes. The transmitter does not save any values.

>Q suppressed<

☛ Enter a positive flow value. Negative values are not possible. The specified value is interpreted as absolute value and is effective as positive and as negative value.

The system will automatically set the measurement values to "0" as soon as the current calculated measurement values lower than this entered value.

>v suppressed<

This setting is to suppress low-flow volumes in applications with large profiles and high flow levels. Lowest velocity changes may cause high apparent volume fluctuations over a long period which cannot be hidden by using the >Q suppressed< parameter. As soon as the flow velocities are lower than the value of this parameter the system will set the values automatically to "0".

Hence the calculated volume is "0" too.

Only positive values are accepted. The specified value is interpreted as absolute value and is effective for positive as well as for negative velocities.

23.1.6 Damping

This menu permits to modify the damping of display and analog output in seconds.

The damping relates to all level and flow velocity values available as input values. Individual values cannot be selected and damped differently.

All measurement values are saved covering the selected period and a floating average value is created for each individual measurement value. This average value will be used for the further flow rate calculation.

Entry is made in steps of 1 second.

Default setting: 30 s

23.1.7 Stability

Stability is the time gap without valid level and flow velocity values and hence without correct measurements bridged by the transmitter.

During this time gap the transmitter operates using the latest valid reading. As soon as the period specified here has expired without detecting a correct measurement value the transmitter will set the reading to "0" considering the damping value set. The transmitter does not save any values.

Entry is made in steps of 1 second.

Default setting: 30 s

23.2 Setting Parameters in h-Sensors Menu

After setting the measurement place parameters it is necessary to define the level sensor(s) used and to determine the according measurement ranges.

Level sensor parameters can be adjusted in the >h-Sensors< submenu.

23.2.1 h-Sensor Types

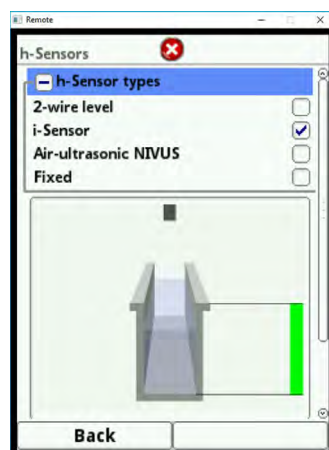

Fig. 23-8 Selecting the h-sensor types

In the >h-Sensor Types< field a selection of level sensors is available. Open parameter >h-Sensor Types<.

Select the sensor type connected to the transmitter. In most cases it is sufficient to choose a level sensor.

If more than one level sensor is used (e. g. i-Sensor and 2-wire level) tick each sensor.



Note

Selected sensors which have not been connected cannot be generated by the transmitter. After finishing the parameter settings the transmitter recognises the missing or incorrectly selected sensor and will issue an error message.

The number of selected sensors is equal to the number of the selected level measurement ranges over the entire measurement cross section. Only one level sensor can provide a current reading per measurement. The transmitter does not accept incorrect and erroneous combinations.

A maximum of up to three different level sensors can be chosen.

The settings of the sensor measurement ranges can be adjusted below the channel graph.



Note

The transmitter does not recognize the type of 2-wire level sensor connected. This is why the sensor representation on the display is not relevant for the measurement range. Per default the transmitter will indicate the 2-wire level sensor on the display as ultrasonic sensor measuring from top down.

Example

Air-ultrasonic sensor on the top facing downwards; pressure sensor and water-ultrasonic sensor on the channel bottom.

The level sensors are indicated within the channel shape which has been set before in the measurement place parameters section.

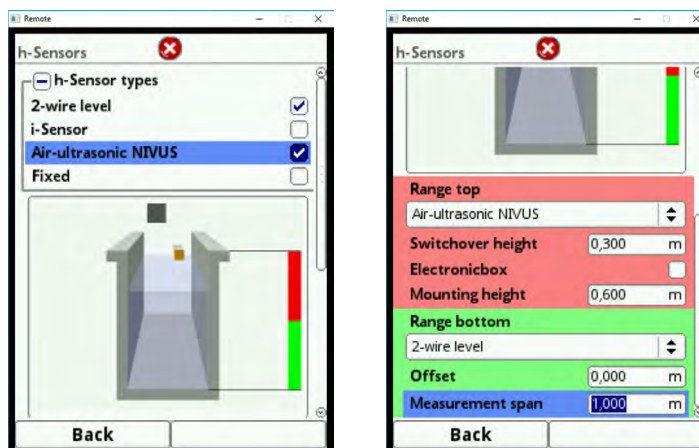

Fig. 23-9 Selecting the level sensors

Select from the following level sensor types:

- **2-Wire Level**
Level measurement by using an external 2-wire sensor supplied by the transmitter.
Example: pressure probe type NivuBar Plus or compact echo sounder type NivuCompact. Possible 0/4...20 mA-signals from an external transmitter such as NivuMaster or MultiRanger can be activated here too.
- **i-Sensor**
Connect ultrasonic i-Series sensors by NIVUS here. Connection is carried out via the HART interface.
- **NIVUS Air-Ultrasonic**
Level measurement from top down using an air-ultrasonic sensor type OCL-L1 or DSM-L0. Such sensors are used for measurement in low flow levels. The level sensor shall be installed in the centre of the channel crown ($\pm 2^\circ$) parallel to the water surface.

- **Fixed Value**
This selection is conceived for permanently full pipes and channels. Level measurement is not required for such applications. The constant filling level is set as fixed value and then used by the system to calculate the flow rate.
This parameter can be used as support for initial start-up or for test purposes without having level values available.

23.2.2 Definition of Measurement Ranges

A vertical coloured bar is indicated on the right-hand side of the channel graph depending on the type and number of selected sensors. This bar specifies the working area of the individual sensors using the according colour.

- Measurement range
 - Top: red
 - Centre: yellow
 - Bottom: green
- Number of sensors used
 - one sensor: solid green bar
 - two: combination green/red

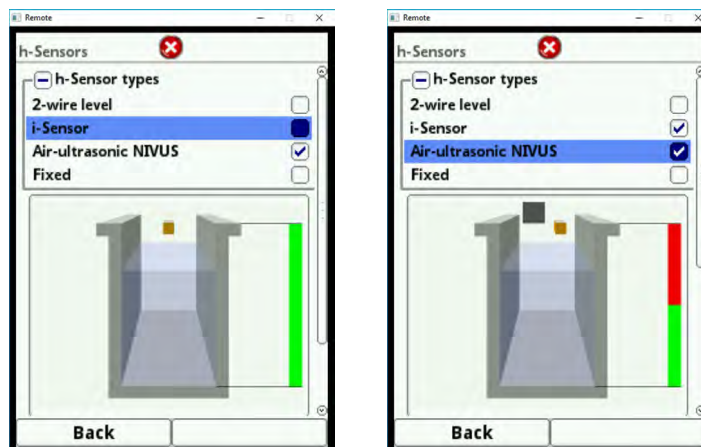

Fig. 23-10 Selection of sensors and representation of measurement ranges

On to three coloured programming sections are indicated below the channel graph depending on type and number of the selected sensors. The colour of these programming sections corresponds with the colour of the vertical bar as well as the assigned sensors.

- Measurement range
 - Top: red
 - Centre: yellow
 - Bottom: green
- Number of sensors used
 - one sensor: solid green bar
 - two: combination green/red

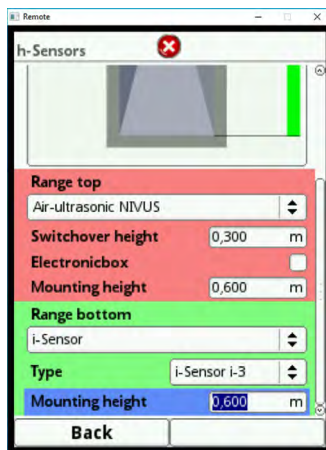

Fig. 23-11 Representation of programming sections

A level sensor can be assigned to each one of the programming sections (see Fig. 23-9). The transmitter will assign the sensors to the appropriate programming section automatically. The assignment depends on the channel shape set before.

- e. g. Air-ultrasonic: bottom measurement range

This assignment can be modified as desired. The assignment menu will show only the sensors which have been selected previously (Fig. 23-9).

It is also possible to use one level sensor for two or three programming sections.

In such a case the other level measurement values activated will be saved only in the internal memory and will not be used for calculation purposes.

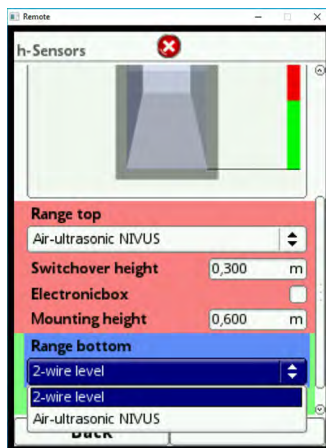

Fig. 23-12 Assigning level sensors to programming sections

The range of each programming section can be modified. This modification is done by adjusting the according >Switchover Level<.



Important Note

Observe to accurately specify the positioning values of the individual sensors.



Important Note

When using i-Sensors (connection via HART interface) necessarily observe to specify the correct sensor type. The transmitter automatically accepts the sensor-specific data.

In the i-Sensors menu tick iXT/MPX as soon as the i-Sensor is connected using the HART interface of an iXT.

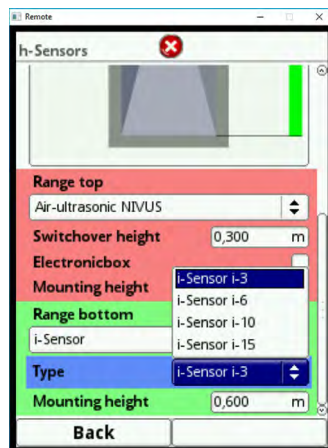

Fig. 23-13 Programming i-Sensor



Important Note

If the i-Sensor is connected via a type iXT Ex Separation Module it is necessary to enable the use of iXT/MPX in Main Menu/Connections prior to setting the sensor type. Without this activation the connection cannot be selected in the >h-Sensors< menu.

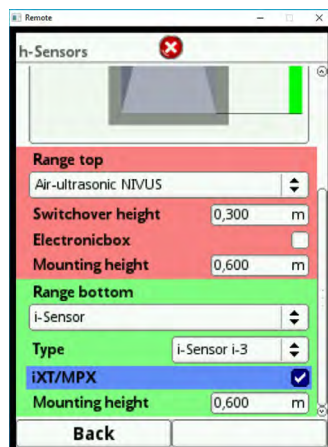

Fig. 23-14 Activation HART interface in iXT

The specification of the mounting height of the i-Sensor relates to the distance between the bottom sensor edge and the channel zero point. This value defines the zero point of the measurement. It is essential to set this value carefully and as accurate as possible since this setting will influence the measurement using i-Sensors immediately.

23.3 Setting Parameters in v-Sensors Menu

The third important point besides the measurement place and the level sensors is the setting of the flow velocity sensor parameters. This menu comprises among the sensor type and the number of sensors even the spatial position. Specifications within this menu relate to the shape as well as the dimensions of the defined channel shape (see chapter „23.1.2 Channel Profiles“).

23.3.1 Number of Flow Velocity Sensors

It is possible to connect more than one flow velocity sensor to the NivuFlow 550 transmitter.

The number of connectable sensors depends on the transmitter type:

- NivuFlow 550 type R1 – one flow velocity sensor



Fig. 23-15 Selection menu flow velocity sensors

23.3.2 Sensor Types

Radar measurement

- OFR

23.3.3 Sensor Mounting Position

For the installation of v-sensors it is possible to specify additional application parameters. These specifications are conceived mainly for installation positions other than the default settings.

➡ Procedure:

1. Turn the rotary-pushbutton until the >Mounting< field is highlighted in blue.
2. Press the rotary-pushbutton - the PLUS on the left turns to MINUS and an input menu opens.

In the input menu the mounting height can be specified and the installation direction can be selected.

Input Field Mounting Height

➡ Procedure:

1. Measure the distance between the bottom edge of the base plate (v-sensor) and the lowest point of the channel bottom.

2. Turn the rotary-pushbutton until >Mounting Height< is active.
3. Enter the measured distance here.
Default setting: unit METER.



Fig. 23-16 Setting the mounting height

Installation Direction

This particular parameter is used only for special applications.

Default setting: sensor installation direction always >positive< (measuring against the flow direction).



Note

Do not modify this parameter. Entering >negative< will provide invalid flow velocity values.



Fig. 23-17 Sensor installation direction altering options

23.3.4 v-Minimum and v-Maximum

The settings for v-Minimum and v-Maximum determine the limit values for velocity measurement. Single higher or lower velocity peaks will be rejected by the transmitter and are not indicated. Deviations measured permanently are indicated as "0" causing the transmitter to return to standard indication not before realistic results are measured.

Values between -15 to +15 m/s can be set.

Default setting:

- v-Minimum: -10 m/s
- v-Maximum: 10 m/s



Fig. 23-18 v-Minimum/-Maximum

23.3.5 Data Transmission Rate

Baud Rate

The baud rate denotes the number of transmitted symbols per time unit and hence describes the transmission speed.

Default setting: 57 600 baud.

NIVUS strongly recommends to maintain this setting. The radar sensor is calibrated to the standard baud rate of 57 600 baud. The measurement may be massively impaired as soon as this standard setting is modified.

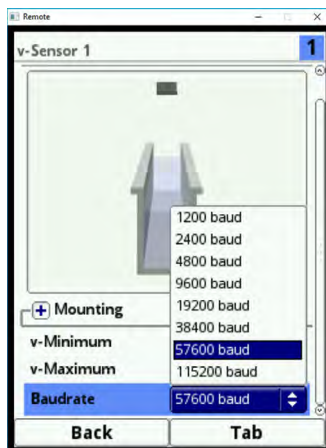

Fig. 23-19 Baud rate

23.4 Inputs and Outputs (analog and digital)

This menu is to define the functions of the analog as well as digital inputs and outputs. Further parameters such as measurement ranges and output spans, offsets, limit values, error responses etc. can be set here too.

Open the >Inputs/Outputs< menu from the main menu.



Fig. 23-20 Selection of inputs and outputs

The Inputs/Outputs menu is subdivided into four parts:

- Analog inputs
- Analog outputs
- Digital inputs
- Digital outputs

23.4.1 Analog Inputs

The number of analog inputs depends on the instrument type:

- Type R1 = two analog inputs

The available analog inputs are shown in the top right corner of the display.

The analog inputs can be selected successively by pressing the right-hand control key >Tab<. The selection is shown as clear text message in the top left corner of the display.

Default setting: analog inputs inactive.

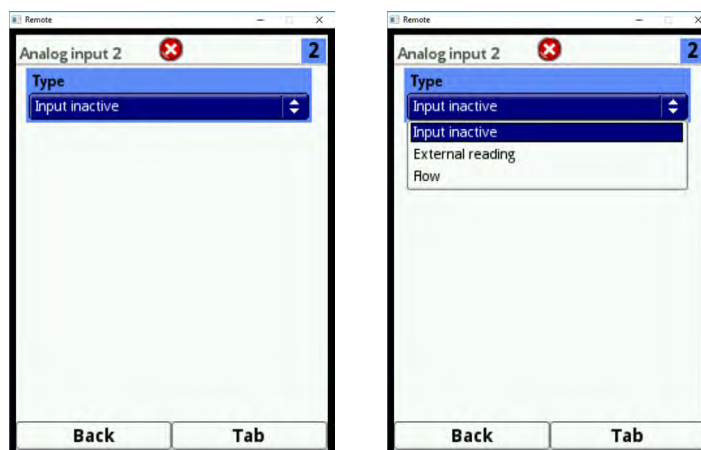

Fig. 23-21 Activation of analog inputs

Currently the analog inputs can be used only for external readings (such as temperature in °C). The transmitter hence can be utilised as an extra data logger for readings from other systems. This, however, does not affect the transmitter's functionality as flow meter.

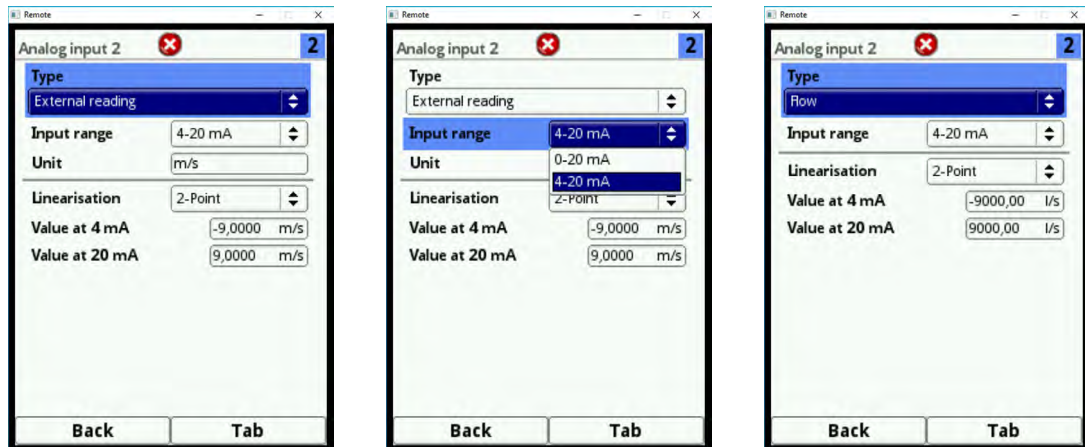

Fig. 23-22 Analog input parameters

After activating the analog inputs the input ranges can be set to either >0-20 mA< or >4-20 mA<.

The units selection field can be used as text input field if "External Measurement Value" has been selected in order to enter individual units optionally. The number of characters for the individual input of units is limited to five digits.

For "Flow" the unit (according to the units selected with the language settings) is fixed and cannot be modified.



Note

Keypad input: see chapter „20 Operation Basics“.

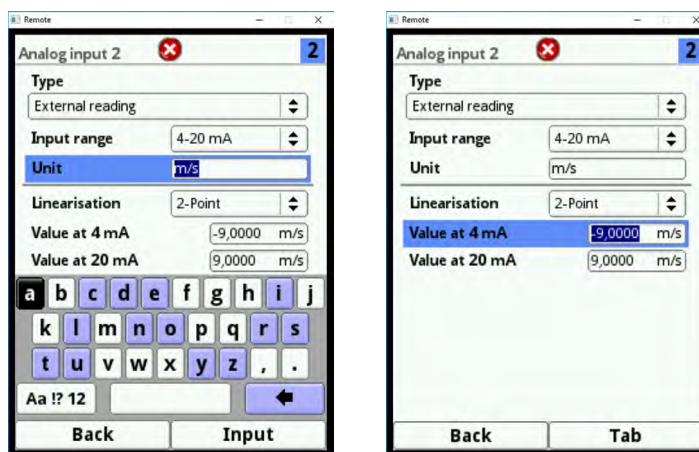

Fig. 23-23 Determination of units and scaling of storage

Then set the parameters for the scaling of the storage.

23.4.2 Analog Outputs

The number of analog outputs depends on the instrument type:

- Type R1 = two analog outputs

The available analog outputs are shown in the top right corner of the display.

The analog outputs can be selected successively by pressing the right-hand control key >Tab<. The selection is shown as clear text message in the top left corner of the display.

Default setting: Analog outputs inactive.

The analog outputs can be assigned to varying functions. It is possible to assign the same function in different measurement ranges to two analog outputs.

- Example:
 - Analog output 1 = flow 4-20 mA is equal to 0-100 l/s
 - Analog output 2 = flow 4-20 mA is equal to 0-5000 l/s

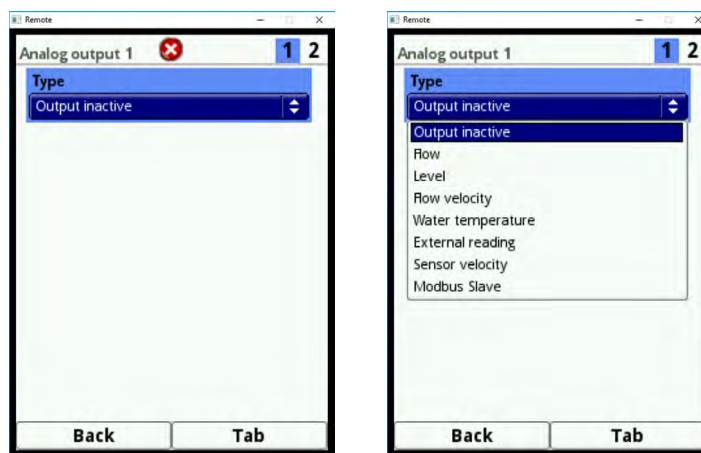

Fig. 23-24 Activation of analog outputs

The functions below can be assigned to an analog output:

- **Flow**
The application flow rate (calculated from average flow velocity and wetted cross section) is available on the selected analog output.
- **Level**
The level used for calculation is available on the selected analog output. This is the level value active in menu >Application</>h-Sensors< for the current level area.
- **Flow velocity**
The calculated average flow velocity (possibly calculated even from two or three sensors) used to calculate the current flow rate is available on the selected analog output.
- **Air temperature**
This is where the measured air temperature is available as soon as an air-ultrasonic sensor type OCL-L1 is used for the application. The sensor utilises the air temperature to compensate sonic runtime errors.
- **Water temperature**
The medium temperature detected by POA or CS2 flow velocity sensors is available on the selected analog output.
This function cannot be used at present.

- **Sludge level**
In applications measuring volumes from top down by using a float, an external or an OCL sensor for level detection as well as a water-ultrasonic sensor at the same time, it is possible to determine and to output the sludge level from the difference between both level sensors considering the depth of immersion.
- **External measurement value**
Readings fed to the analog input (and possibly linearized) are available here.
- **Sensor velocity**
If multiple flow velocity sensors are in use and the average flow velocity of the individual measurement paths is to be determined it is possible to select the desired flow velocity sensor and to issue its readings on the analog output.

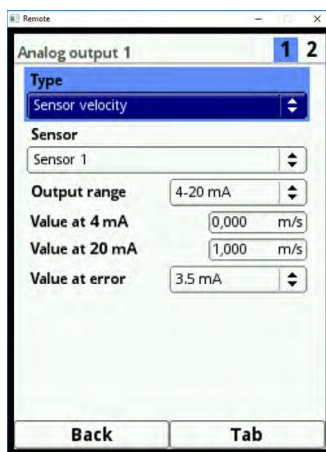

Fig. 23-25 Selecting the sensor velocity

- **Modbus Slave**
Using Modbus the analog output can be used for controlled output of signals from other systems. The output range can be set after the function has been chosen:
 - 0-20 mA
 - 4-20 mA
 Then adjust the output span.
 A certain error behaviour can be set for the analog output in case of error. The adjustments below can be set in case of error:
 - 0 mA
 - Hold value (holds the latest valid reading (Hold))
 - 3.5 mA
 - 21 mA

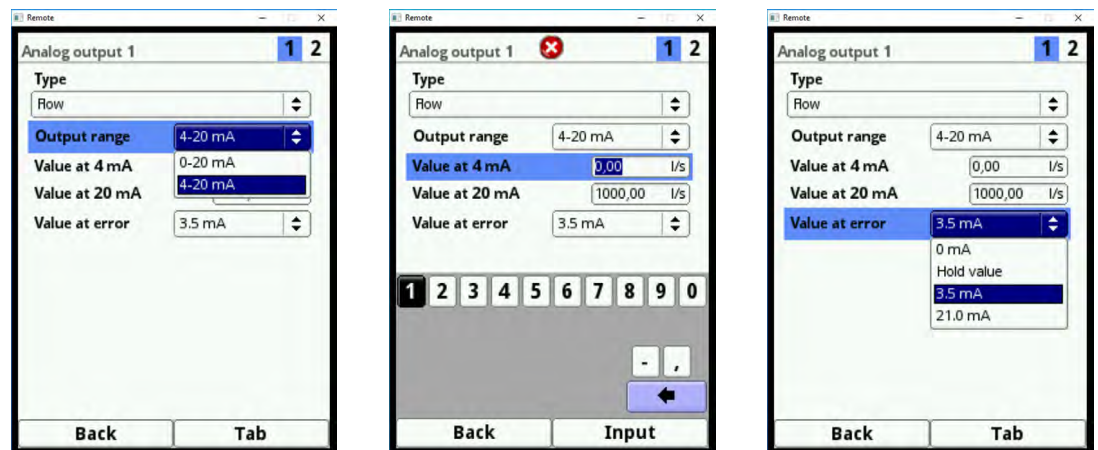

Fig. 23-26 Output range/output span/error response

23.4.3 Digital Inputs

The number of digital inputs depends on the instrument type:

- Type R1 = two digital inputs

The available digital inputs are shown in the top right corner of the display.

The digital inputs can be selected successively by pressing the right-hand control key >Tab<. The selection is shown as clear text message in the top left corner of the display.

Default setting: digital inputs inactive.

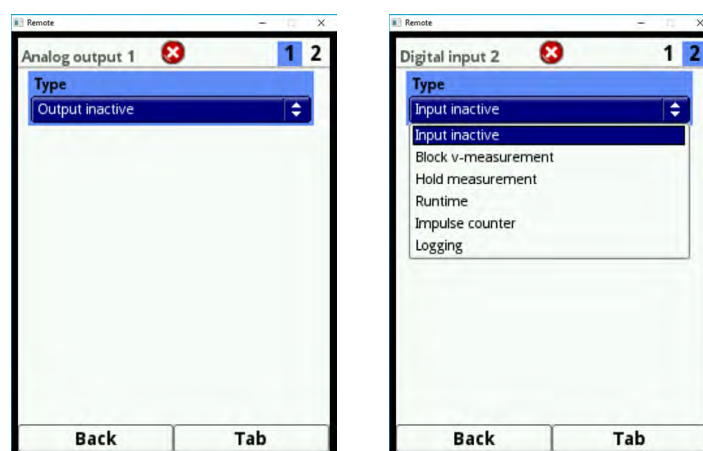

Fig. 23-27 Activation of digital inputs

The following functions can be assigned to the digital inputs:

- **Block V-measurement**
The flow measurement can be blocked as long as there is a signal available on the digital input by using an external contact (float switch, pressure bell switch, ...). This is useful for applications such as very full overflow channels without actual discharge featuring movement caused by wind, waves, ship traffic or similar. The measurement here is released using a contact maker installed in the separating structure. The contact maker shall be positioned immediately before the overflow start. If this function is selected the logic can be additionally adjusted as follows:
 - non-inverting digital input
 - inverting digital input

- **Runtime**
The system detects and saves the duration of the oncoming signals on the digital input. Such records are used e. g. for the runtimes of pumps or other units.
If this function is selected the logic can be additionally adjusted as follows:
 - non-inverting digital input
 - inverting digital input

- **Impulse Counter**
The system counts and saves the number of oncoming signals on the digital input. The impulses are counted by detecting the status change of the digital input (1->0 or 0->1).
If this function is selected it is possible to determine which edge to evaluate:
 - rising edge (status change "0" to "1")
 - falling edge (status change "1" to "0")

- **Recording**
An oncoming signal is recorded including start and stop (time stamp function) and is then saved.
Areas of use:
 - Access control
 - Recording of events
 - Runtimes
 - etc.
 If this function is selected the logic can be additionally adjusted as follows:
 - non-inverting digital input
 - inverting digital input

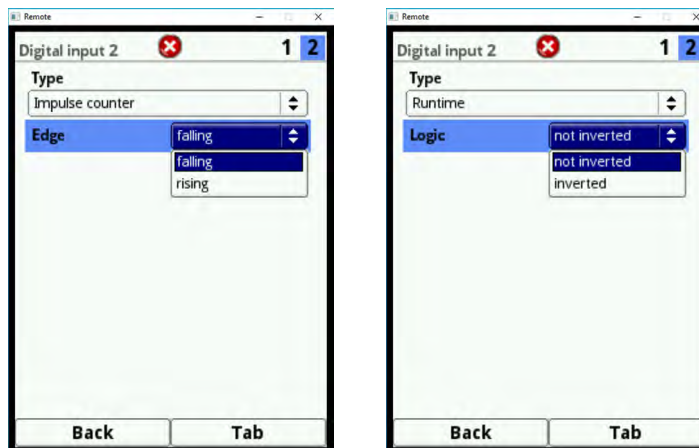

Fig. 23-28 Logic options

23.4.4 Digital Outputs

The number of digital outputs depends on the instrument type:

- Type R1 = two digital outputs

The available digital outputs are shown in the top right corner of the display.

The digital outputs can be selected successively by pressing the right-hand control key >Tab<. The selection is shown as clear text message in the top left corner of the display.

Default setting: digital outputs inactive.

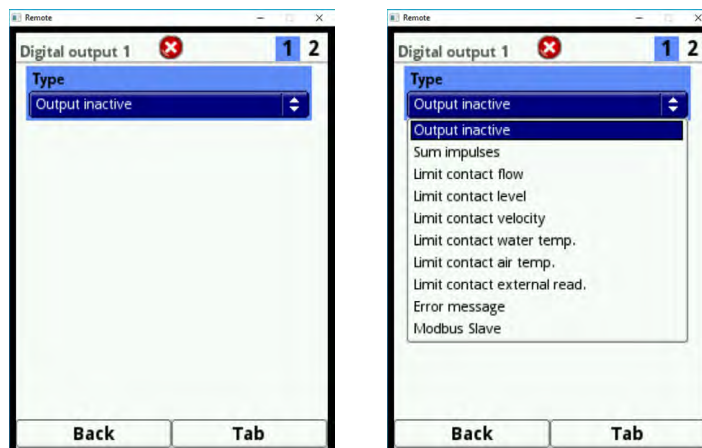

Fig. 23-29 Activation of digital outputs

The following functions can be assigned to the digital outputs:

- **Sum impulses**
Output of volume-proportional sum impulses.
The parameters below can be set:
 - Value (impulse per volume)
 - Output logic (n.c./n.o.)
 - Impulse duration (relay energised/de-energised); duration: 100...5000 ms

If the output frequency of the impulse output is lower than the frequency of the flow rate in case of strongly rising flow rates the sum impulses not yet issued will be saved internally until the calculated flow rate falls below the impulse frequency again. After that the sum impulses will be issued.

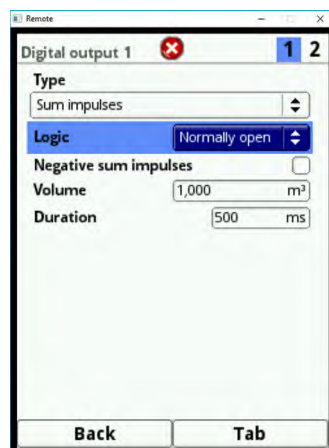

Fig. 23-30 Programming the impulse generator

- **Limit Contact Flow**
Set one flow limit value for >Threshold On< and >Threshold Off< each. Exceeding this flow limit value will issue a digital signal. This digital signal will be reset as soon as the value falls below the second flow limit value = hysteresis function to avoid output flutter.
After selecting this function the logic can be adjusted as follows:
 - normally closed
 - normally open



Fig. 23-31 Programming the limit contact

- **Limit Contact Level**
The procedure to use the level limit contact is the same as for the flow limit contact.
Set a level limit value.
The level enabled in >Application</>h-Sensors< for the current level range is used for calculation. It is not possible to use a free selectable level sensor.
After selecting this function the logic can be adjusted as follows:
 - normally closed
 - normally open
- **Limit Contact Velocity**
Here the digital signal in the event of overshooting an adjustable velocity limit value will be issued.
Proceed as described under >Limit Contact Flow<.
The calculated average flow velocity (calculated even from 2 or 3 sensors) is used.
After selecting this function the logic can be adjusted as follows:
 - normally closed
 - normally open
- **Limit Contact Sludge**
In part filled applications the sedimentation level can be determined and issued.
Prerequisites:
 - Float used
 - Determination of sedimentation distance using water-ultrasound from the float down
 - Determination of water surface level using an external sensor or air-ultrasonic sensor type OCL

The sedimentation level can be calculated from the difference between both level sensors. Here the immersion depth of the water-ultrasound must be taken into account.

Observe:

Soft sludge levels possibly do not reflect ultrasonic signals. In such a case the sedimentation level cannot be calculated.

- **Error message**

The individual error types to issue can be assigned to the digital output by ticking the according check boxes using the rotary-pushbutton.

Furthermore it is possible to toggle the output logic between normally open and normally closed.



Note

Digital output 2 is not suitable as error output since it is designed as a bi-stable relay. Once de-energised the relay will retain its latest position and hence cannot be used for error messages.

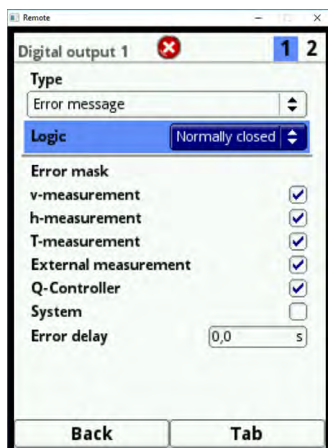

Fig. 23-32 Error mask

- **Modbus Slave**
The digital output can be used via the Modbus for the controlled output of signals from other systems.

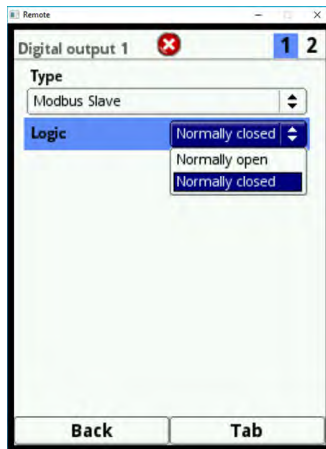

Fig. 23-33 Logic options

23.5 Diagnosis

The diagnosis menu is described in chapter „Diagnosis“ starting at page 109.

24 Data Parameter Menu

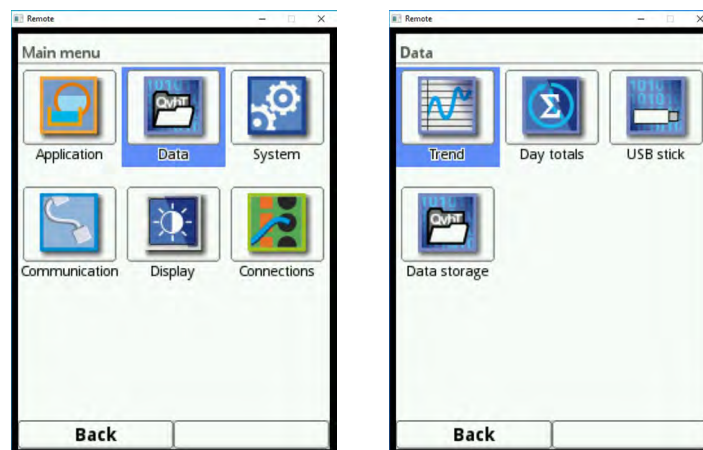

Fig. 24-1 Data menu

24.1 Trend

The trend graph is a representing recorder function. Once you have selected the trend graph you can access previously saved (historic) measurement data.

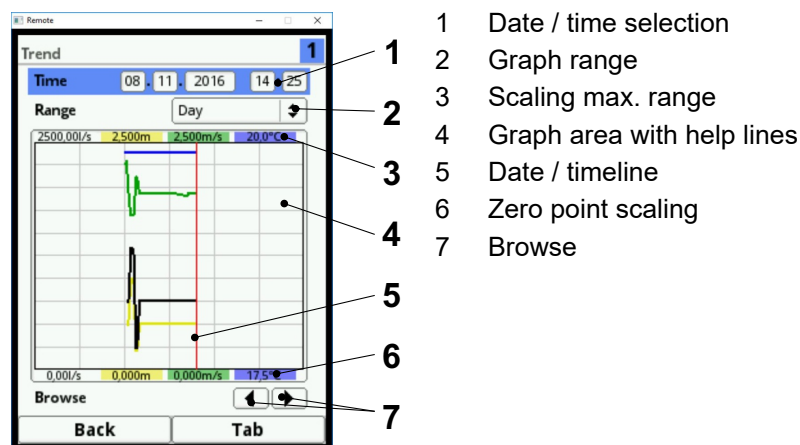

Fig. 24-2 Trend graph screen

➡ Procedure for representation of current measurement data:

1. Select the desired range (period of representation).
The selected range is shown. Measurement data are not automatically updated while represented (the current readings can be found in the lower third of the main screen).
2. In order to get back to the main screen press the left function (Back) three times.

The **Date/Time Selection** (Fig. 24-2 Pos. 1) can be found in the top area of the main screen. The line is highlighted blue and hence active.

➡ If you wish to select readings covering a certain period (historic data) proceed as follows:

1. Turning the rotary-pushbutton engages the first field (day).
2. Specify the desired day.
3. Turning the rotary-pushbutton again takes you to the next field (month).

4. Repeat your entry until the desired time (day, month, year, hour, minute) is specified completely.
5. Confirm your entry with the right function key. Date and time will be accepted. The readings are shown in the display depending on the date and the period selected (Fig. 24-2 Pos. 2). The vertical red line (Fig. 24-2 Pos. 5) marks the selected point of time (date and time).

↩ Interrupt your entry by pressing the left function key (back).

Representation:

The selected period covers the area between the left and the right display margin.

The **period** within which data are to be represented can be modified.

↩ Modify the setting using the >Range< section (see Fig. 24-2 Pos. 2).

1. Turn the rotary-pushbutton until >Range< is highlighted blue.
2. Press the rotary-pushbutton – the selectable periods are shown.

Available are:

- 1 hour
- 4 hours
- 1 day
- 1 week
- 4 weeks

3. Turn the rotary-pushbutton until the desired section is highlighted blue.
4. Confirm your entry with the right function key. The desired period will be accepted.

Representation:

- The vertical red line marks the selected point of time (date and time).
- The representation grid is internally fixed.
- The selected period >Hour< always begins left with minute "0" end ends right with minute "59".
- For increased readability the screen is divided by three vertical help lines. Each division represents a period of 15 minutes.

Underneath the display you can find the **function >Browse<**.

Use the arrow symbols to browse one hour forwards or backwards each time you press the button.

If **period >4 hours<** is chosen the start of the representation depends on the selected point of time.

Depending on the start time the representation begins:

- 00:00 h
- 04:00 h
- 08:00 h
- 12:00 h
- 16:00 h
- 20:00 h

Representation:

- The range of representation ends exactly 4 hours later on the right side.
- This representation is divided by three vertical help lines too. The distance between the lines is one hour.

Use the >Browse< function to move backwards and forwards within this screen in steps of 4 hours.

If **period >Day<** is chosen the representation begins always on the left at hour 00:00 and ends on the right at hour 24:00.

Representation:

- For increased readability the screen is divided by five vertical help lines. Each division represents a period of 4 hours.

Use the arrow symbols to browse one day forwards or backwards each time you press the button.

If **period >Week<** is chosen the representation begins always on the left at "Monday 00:00 h" and ends on the right at "Sunday 24:00 h".

Representation:

- For increased readability the screen is divided by six vertical help lines. Each division represents one weekday.

Use the arrow symbols to browse one week forwards or backwards each time you press the button.

If **period >4 Weeks<** is chosen the representation begins always on the left at "Monday 00:00 h" and ends on the right at "Sunday 24:00 h".

Representation:

- The reference point in time of the 4-weeks representation is the 29.12.1969, 00:00 h.
- For increased readability the screen is divided by three vertical help lines. Each division represents a period of 7 days.

Use the arrow symbols to browse four weeks forwards or backwards each time you press the button.



Note

Once the period >4 Weeks< is selected it may take a few seconds to load the data completely.

24.2 Day Totals

This is where the flow totals can be viewed in a table. Each value represents a period of 24 hours.

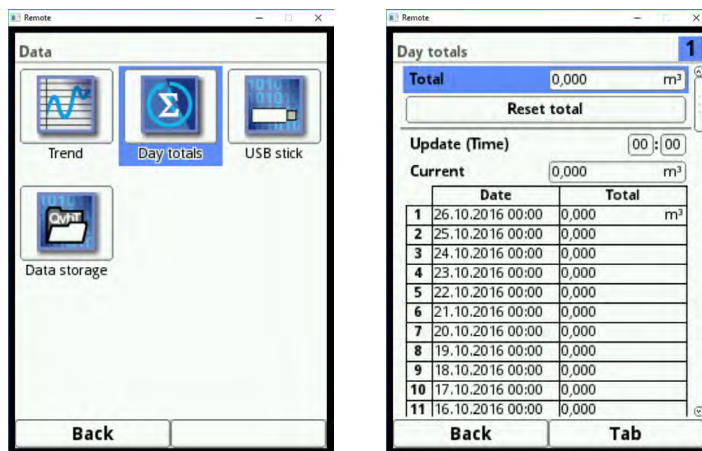

Fig. 24-3 Day Totals

A maximum of 100 totals (= 100 days) is stored. Starting with value 101 always the oldest value will be overwritten (ring memory).

- Turn the rotary-pushbutton to the right to scroll down the table and to the left to scroll up again.

It is possible to view older day totals as well. A prerequisite to view older values is that the unit has run for a longer period.

Example: 98 values – the unit is running for 98 days

In general, only totals created during days with the transmitter actually powered up can be viewed.

If the transmitter should be shut down between two totalising events (< 24 hours) a total will be calculated by using **measured values**. Such a total is **not equal** to the real daily flow rate but corresponds to the rate measured by the transmitter while powered up.

Should the transmitter be shut down before the next totalising event and remains to be shut down until the moment of the following totalising event (> 24 hours) no total will be created for this period (see Fig. 24-4). No data will be saved and the period remains to be unnamed. This "gap" can be identified from the completely missing file (date/values) within the list. The transmitter does not create empty lines.

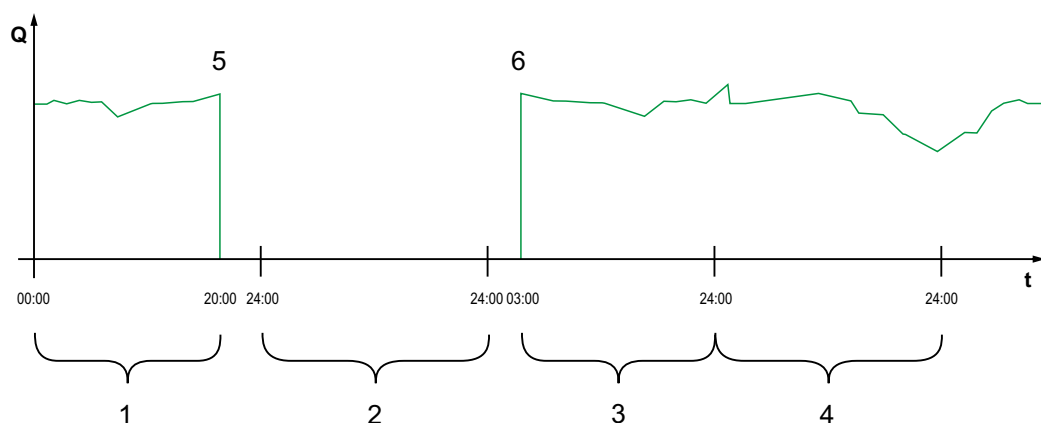

- Total day 1: total covering 20 hours
- Day 2: power failure – no totalising
- Total day 3: total covering 21 hours

- 4 Total day 4: total covering 24 hours
- 5 Power failure
- 6 Power supply restored

Fig. 24-4 Totalising scheme

- The totalising period is set to the period between 00:00 o'clock and 24:00 o'clock as **per default**. This means that the day totals are always created between 00:00 o'clock and 24:00 o'clock.
 - The totals are created at 00:00 o'clock as **per default**.
- ➡ The time of totalising can be modified as follows:
1. Turn the rotary-pushbutton until >Update (Time)< is highlighted blue.
 2. Turn the rotary-pushbutton to activate the hours section.
 3. Specify the desired time to start totalising (e. g. 08:00) and continue turning the button to the minutes section.
 4. Specify the desired minutes.
 5. Confirm your specifications by pressing the right function key >Enter<. The time of totalising has now been changed to 08:00 o'clock.
Due to this settings the 24-h-total will be automatically created covering the period between 08:00 o'clock and 08:00 o'clock of the following day.

The >Current< field indicates the subtotal accrued since the latest totalising event.

24.3 USB-Transfer

Requirements to USB sticks:

- USB 2.0 supported
- FAT 32 format (or FAT 12 or FAT 16)
- maximum permissible memory 32 GB

Working with USB stick:

- ➡ Plug the USB stick into the USB slot located above the display.

Functions:

- Transmission of measurement data to USB stick
- Instrument parameters can be saved to USB stick
- Saved parameter can be restored from USB stick back to the instrument
- Formatting the USB stick



Fig. 24-5 Selection submenu

The transmitter is equipped with an internal data memory. Portions of your measurement data or the complete memory contents can be transmitted to USB stick.

Within this section it is possible to specify the desired period of transmission.

Per default the transmitter is set to transmit the data between the latest transmission and the current point in time. You are free to adjust this period as desired, however.

☞ To transmit data to USB stick proceed as follows:

1. Press the rotary-pushbutton to engage the top field.
 2. Turn the rotary-pushbutton to specify the desired start day.
 3. Turn the rotary-pushbutton again to get to the month input.
 4. Repeat the procedure until the desired date and time have been specified completely.
 5. Confirm your entries by pressing the right function key >Enter<.
 6. Turn the rotary-pushbutton to highlight the >to< field blue blau unterlegt.
 7. Turn the rotary-pushbutton to set the desired stop day.
 8. Specify the desired stop time as described before.
- Now the period of data to be transmitted to USB stick is specified.

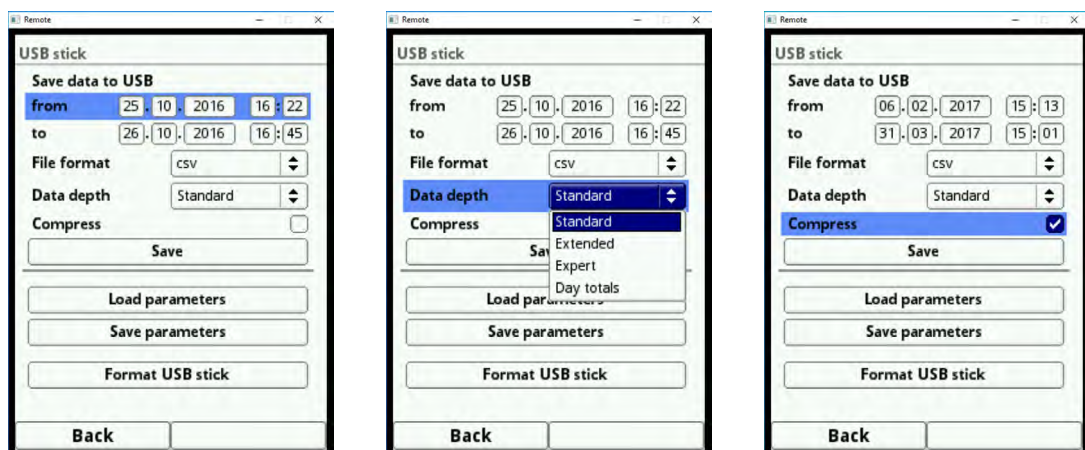

Fig. 24-6 Transmission period/data depth/compression

9. To choose the desired data format turn the rotary-pushbutton which opens a selec-

tion menu.

The formats below are available:

- txt
- csv

10. Press the rotary-pushbutton to accept the data format.

The selectable **data depth** comprises three possible levels:

- **Standard**

This format is sufficient for the most applications. The data sets saved contain the following information:

- Date and time
- Totaliser
- Calculated flow rate
- Filling level
- Average flow velocity
- Water temperature
- Air temperature (if AUS is used)
- Current (voltage) values as well as the calculated values of the enabled analog and digital inputs

- **Extended**

This data set is useful to check critical relevant applications and is mainly used by service personnel.

The data sets saved contain the following information:

- Data and time
- Totaliser
- Calculated flow rate
- Filling level used for calculation
- Average flow velocity
- Water temperature
- Air temperature (if AUS is used)
- Current (voltage) values as well as the calculated values of the enabled analog and digital inputs
- Average flow velocities from v-sensors 1, 2 and 3 (if used)
- Parameter values for the NIVUS-specific velocity evaluation method >COSP<
- Trigger and hydraulic qualities of v-sensors 1, 2 and 3 (is used)

- **Expert**

Such data sets should be used only by specially trained **service personnel** or the **manufacturer's developers**. These data sets may rapidly become very large. Along with the information found in the extended data sets, the expert set additionally contain all individual gate velocities as well as the gate positions of all connected v-sensors.

The **>Compress<** function makes sense only when large data sets are to be transmitted. In such cases the selected files are zipped as ".gz" files. The files can be unzipped again by using the free "7-ZIP" software application.

➤ After transmission period, data format and data depth have been defined the data can be saved on USB stick.

1. Activate the **>Save<** button.
2. Press the rotary-pushbutton to save the data to USB stick.

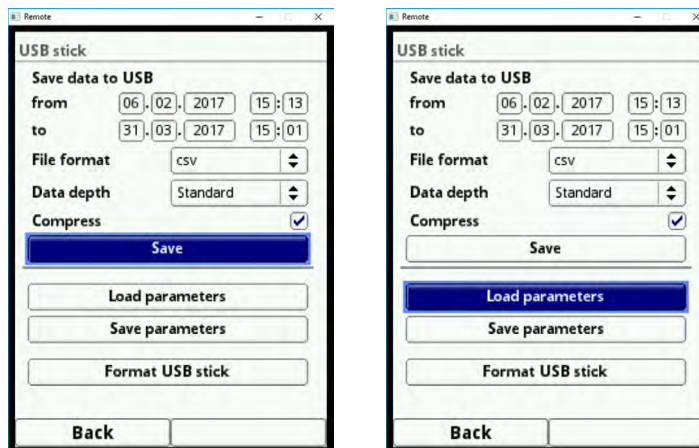

Fig. 24-7 Save/load parameters

The function **>Load Parameters<** permits to load data files previously saved to USB stick back to the transmitter.

By using the function **>Save Parameters<** you can save all parameters of the measurement place to USB stick. During this procedure a total of three files will be created and saved.

Formats of the created files:

- XXXX_DOC_AABBCCDDEE.csv
This file is for documentation purposes and contains basic settings as well as modified parameter settings.
- XXXX_DOC_AABBCCDDEE.xml
This file is conceived for future use with the **>NivuSoft<** software application. It contains basic settings as well as modified parameter settings.
- XXXX_PAR_AABBCCDDEE.xml
This file contains the complete parameter set of the transmitter and is used to save the parameter settings.

Explanation of file names:

- XXXX = Name of measurement place as set
- AA = Year
- BB = Month
- CC = Day
- DD = Hour
- EE = Minute

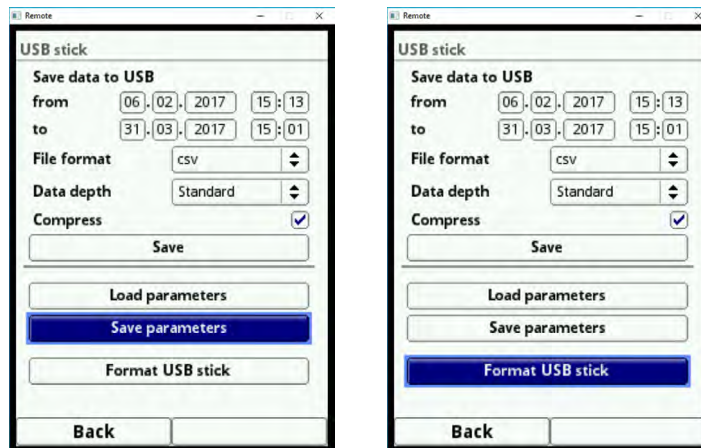

Fig. 24-8 Save parameters/format USB

- ➡ You can convert unformatted or incorrectly formatted USB sticks into the correct format directly on the instrument:
1. Turn the rotary-pushbutton until >Format USB-Stick< is highlighted blue.
 2. Press the rotary-pushbutton to format the plugged USB stick. >SUCCESSFUL< will appear in the display as soon as the stick has been formatted.

24.4 Data Memory (Internal)

This submenu can be used to modify the storage cycle and to erase the internal data memory.

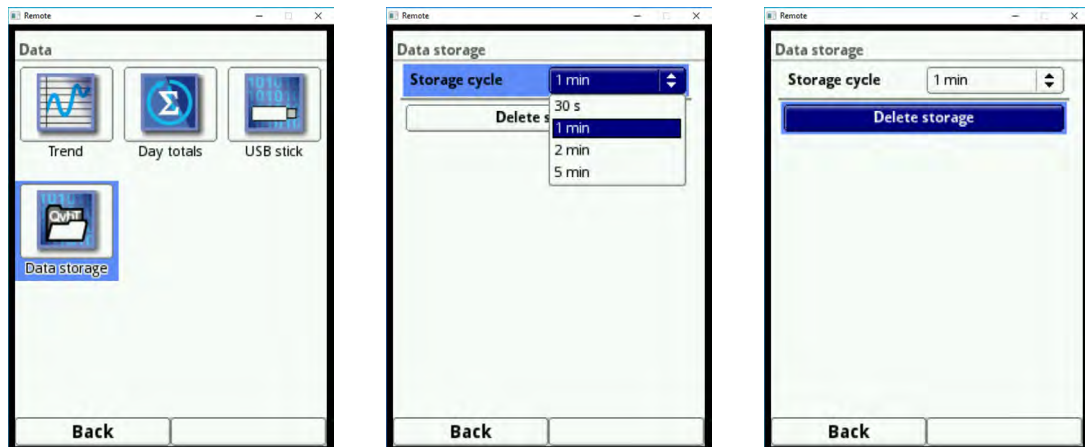

Fig. 24-9 Data memory

Options for the storage cycle:

- 30 s
- 1 min
- 2 min
- 5 min

Default setting for the storage cycle: 1 min

Always the mean value covering the entire cycle is saved instead of the instantaneous value at the moment of storage.

You can **erase** the complete **internal data memory**. The memory is password-protected to avoid unintentional deletion.



Important Note

Erased data cannot be restored!

➡ Procedure:

1. Enter the required password to erase data.
2. Confirm the password with the right function key >Enter<.

25 System

25.1 Information

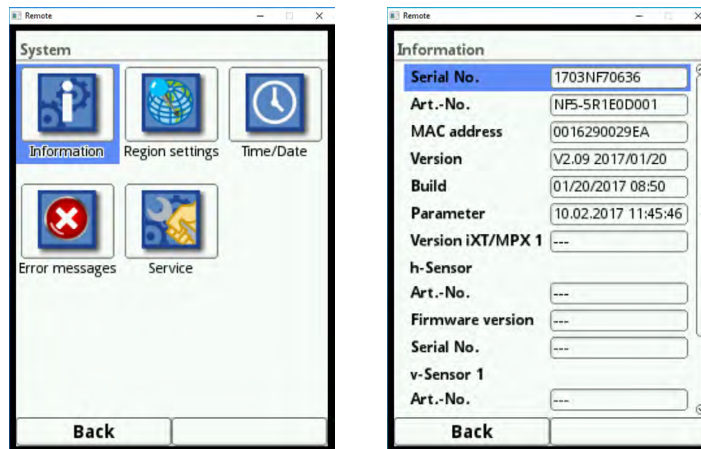

Fig. 25-1 System submenu/system information

This is a read-only menu and contains the instrument information below:

- Serial number and article number
- MAC address
- Firmware version of the transmitter

Furthermore you can find here the following information on the activated flow velocity and level sensors:

- Article numbers
- Current firmware versions
- Serial numbers

25.2 Language Settings

The following settings can be adjusted in this menu:

- (Operation) Language
- Date format
- Units of measurement values

Here it is possible to distinguish between indicated and saved measurement values.



Fig. 25-2 Language settings/language/date format

25.2.1 (Operation) Language

The languages below are currently available:

- English
- German
- French

25.2.2 Date Format

The following date formats can be set:

- DD.MM.YYYY (day/month/year)
- MM/DD/YYYY (month/day/year)

25.2.3 Units

➡ Procedure:

1. Turn the rotary-pushbutton until the field >Units< is highlighted blue.
2. Press the rotary-pushbutton to turn the PLUS on the left to MINUS and to open the selection list at the same time.
3. Turn the rotary-pushbutton to the desired option.

Decimal Separators

- Comma
- Full stop

The decimal separators specified here are used only for indication in the transmitter display.

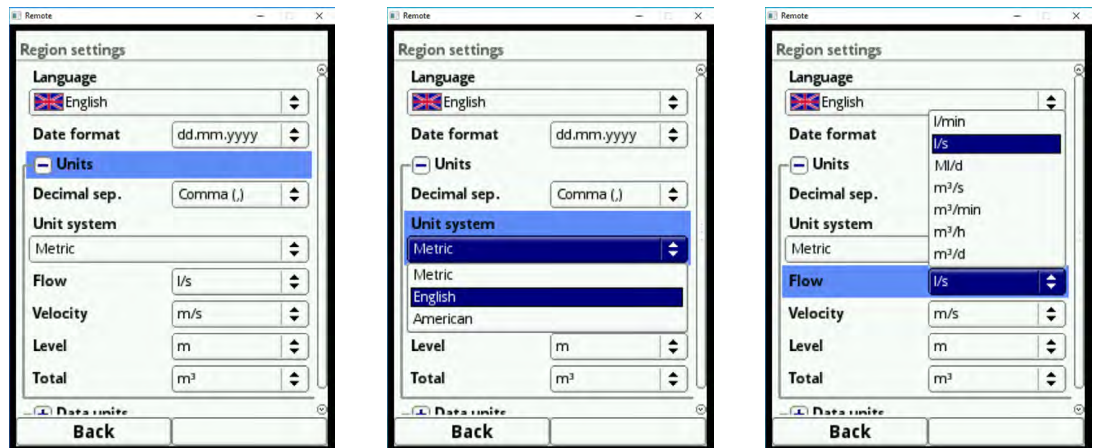

Fig. 25-3 Units system

Units system

Available units:

- Metric
- English
- American

The adjustable units depend on the selected units system:

- In metric system - e. g. liter, cubic metre, cm/s etc.
- In English system - e. g. ft, in, gal/s, etc.
- In American system - e. g. fps, mgd, etc.)

Units for display indication

- Flow
- Flow velocity
- Level
- Total

25.2.4 Memory Units

➡ When adjusting the >Memory Units< proceed right as described under >Units<.

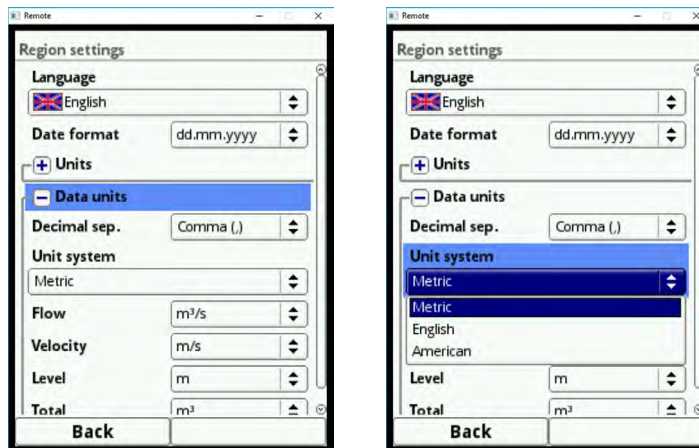

Fig. 25-4 Memory units

In the >Memory Units< section the detected measurement values are converted and saved according to the selected unit.

Decimal Separators

- Comma
- Full stop

Specifying the decimal separators is vital for the correct read-in of data. When evaluating measurement data using other than German software applications (e. g. English Excel) observe to have the decimal separators selected correctly.

Units for storage

- In metric system - e. g. l/s, m³/s, m³/d, cm/s etc.
- In English system - e. g. ft³/s, in, gal/min, Mgal/d, in/s, yd/s etc.
- In American system - e. g. gps, gpm, cfs, cfm, cfh, cfd, mgd etc.

Units for storage of measurement data

- Flow
- Flow velocity
- Level
- Total
- Temperature

25.3 Time/Date

This submenu is used to change the system time of the transmitter and the current date. This function is required to change over summer and winter time, after power failure or if the internal buffer battery should fail. If the transmitter is operated for a long period the internal clock may deviate. The deviations can be corrected here.



Note

Changing the system time will affect data storage. With the data storage enabled double data sets or data gaps may occur after the system time has been changed.

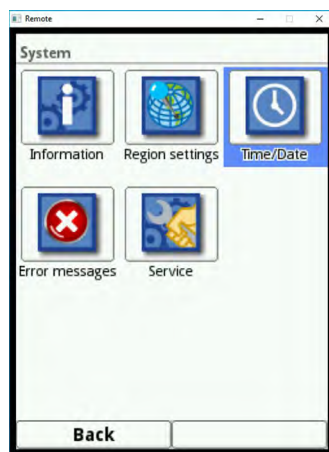

Fig. 25-5 Selecting Time/Date

Here the current system time as well as the time zone (UTC or GMT) relative to the zero meridian can be adjusted.

Furthermore the time server (SNTP) can be activated here.

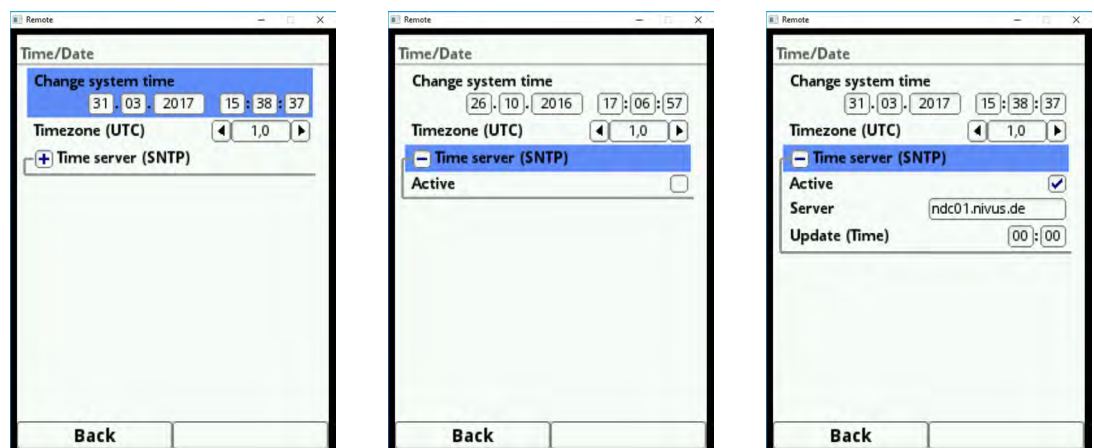

Fig. 25-6 Settings

25.4 Error Messages

In this menu it is possible to recall the current oncoming error messages and to delete the error memory.

The memory is password-protected to avoid unintentional deletion.

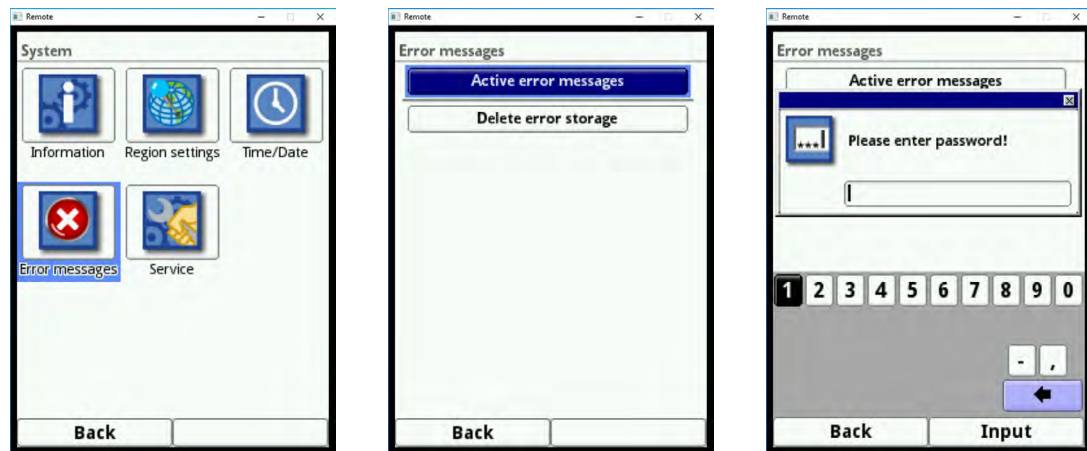

Fig. 25-7 Error messages

25.5 Service

This submenu contains the following functions:

- Service level (unlock)
- Change password (system, not service level)
- Restart (system)
- Restart measurement
- Parameter reset

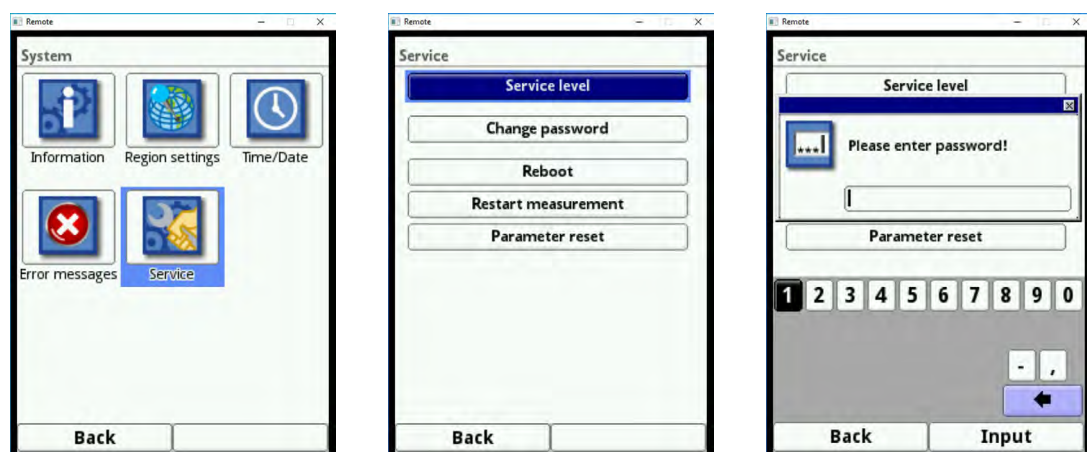

Fig. 25-8 Service

Service Level

The service level is reserved to the NIVUS customer service as well as authorised expert companies and hence is protected by a **special service password**.

System-relevant modifications and special settings for particular applications can be adjusted here.

Such modifications shall be executed by the NIVUS commissioning personnel exclusively!

25.5.1 Change (System) Password

Default password: "2718"

NIVUS recommend to change this password in order to protect the system from unauthorised access. You are free to select any password with a maximum length of ten digits.

For your own safety we recommend to share your password only with **authorised individuals**.

Once you have changed the password it **cannot** be restored by NIVUS!

If your password should get lost it is necessary to execute a total system reset. In such a case all parameters previously set will be lost and must be set again.

Write down your password and store it in a safe place.



See also chapter „21.2 Change Password“.

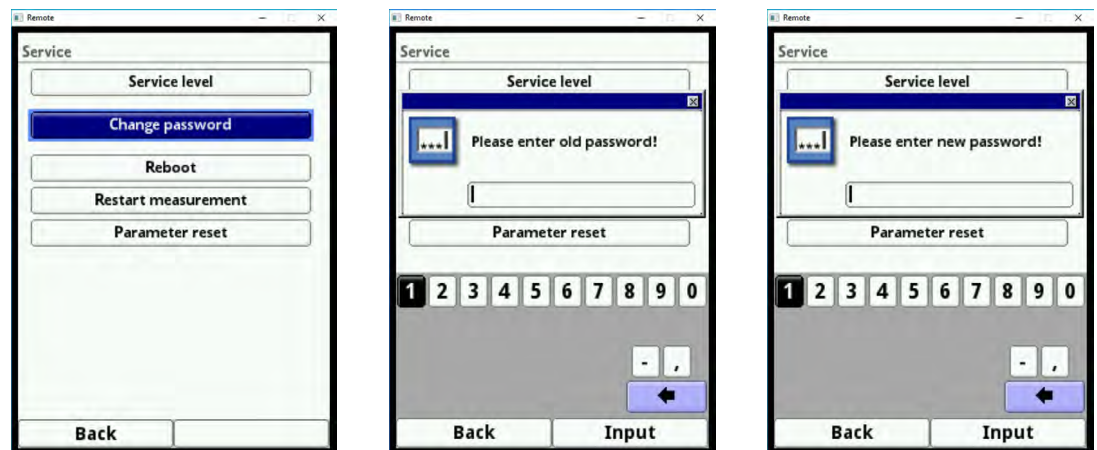

Fig. 25-9 Changing the (system) password

25.5.2 Restart

A transmitter restart will interrupt the current measurement process.

The system will reboot using the parameters set (saved). After booting the system behaves as when the instrument is switched on (analog to PC).

This menu point replaces the system shutdown and reboot. All parameters, counters and saved data are retained.



Fig. 25-10 Restart

25.5.3 Measurement Restart

This option interrupts the currently running measurement process and starts a new measurement.

25.5.4 Parameter Reset

The parameter reset will reset any parameters to default settings. Counters, changed passwords and saved measurement data are retained.

The actual parameter reset is not executed before you exit the parameter settings menu (back to main menu) and the storage is confirmed. The process can be aborted up to this action.

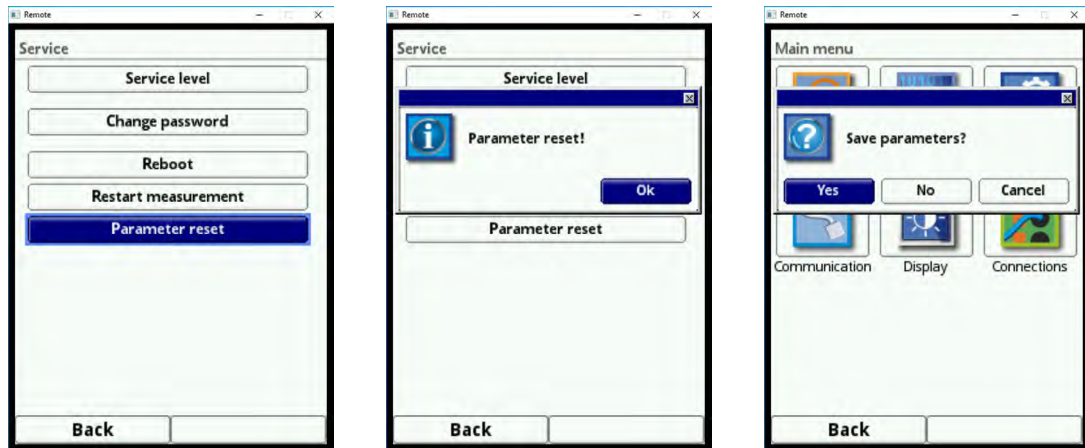

Fig. 25-11 Resetting the parameters to default settings

26 Communication Parameters Menu

This menu is used to set up communication to other devices.

Furthermore the network integration can be set up here as well. The details will not be explained here. If you should not have the required IT skills we recommend to leave such tasks to **IT specialists** or the **NIVUS commissioning personnel**.

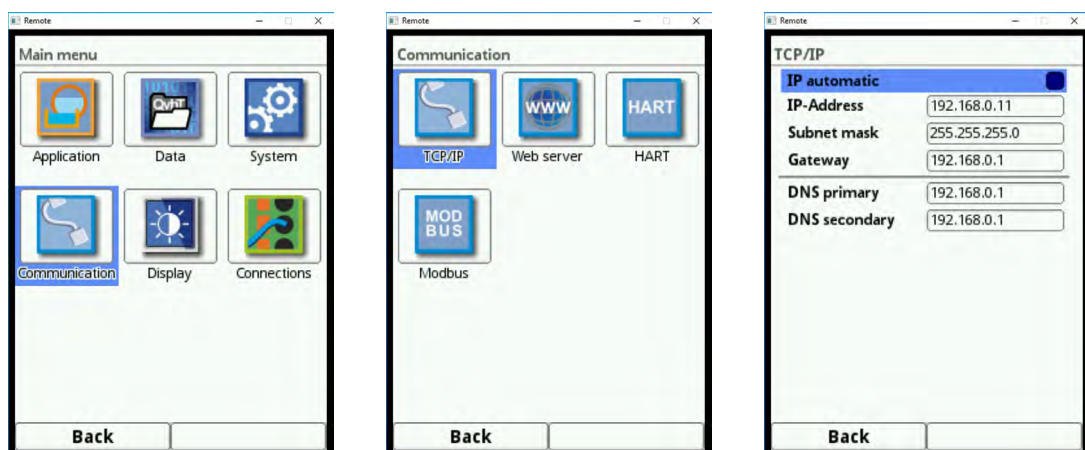

Fig. 26-1 Communication

TCP/IP

Settings for data transport within a decentralised network.

Web Server

The internal web browser of the instrument is currently not supported.

HART

The transmitter can currently not be used as HART slave for following systems.

Modbus

It is possible to integrate the transmitter into other systems via Modbus.

The Modbus protocols available upon request if required. Contact the NIVUS GmbH headquarters in Eppingen.

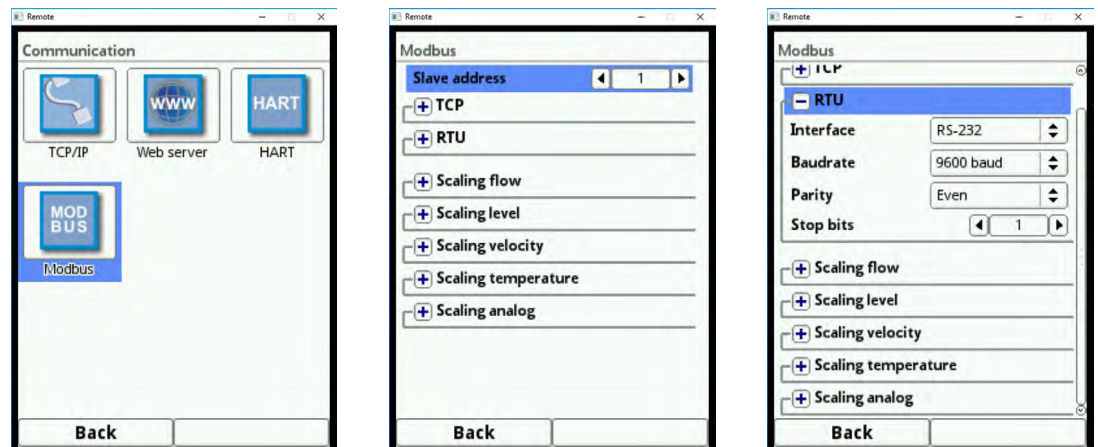

Fig. 26-2 Modbus

The functions below are available here:

- Slave address (1 to 247)
- TCP (port)
- RTU
 - Interface (RS232 or RS485)
 - Baud rate (1200, 2400, 4800, 9600, 19200, 38400, 57600 or 115200 baud)
 - Parity (None, Odd or Even)
 - Stop bits (1 or 2)

Moreover the following scalings can be set:

- Scaling flow
- Scaling level
- Scaling velocity
- Scaling temperature
- Scaling analog values
- Interface settings

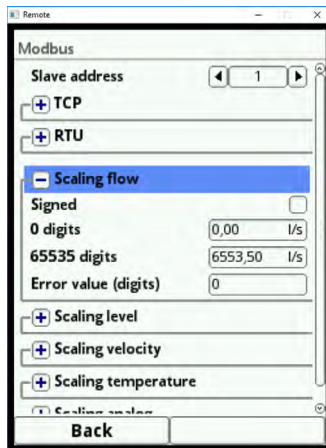

Fig. 26-3 Programming measurement value scaling

27 Display Parameters Menu

In display menu the following settings can be adjusted:

- Backlight
- Designation of the five main screen fields
- Decimal places of individual value representations

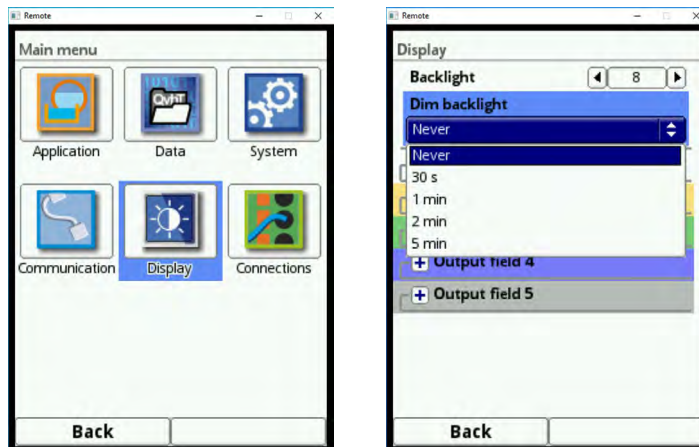

Fig. 27-1 Display/backlight/delay time

Backlight

The backlight can be adjusted in ten levels.

Adjust the backlight to the ambient conditions. Avoid setting the display too bright.

In order to extend the display life NIVUS recommend to enable the automatic display dimming option here (dim light). The display will dim automatically if it has not been used for a certain time. This period can be determined by using the delay time option.

As soon as settings are made on the transmitter (e. g. pressing a key) the display will go back to standard brightness.

Default setting: brightness level "8" and delay time "Never".

Output fields

The five main screen output fields (Flow, Level, Velocity, Temperature and Total) can be freely defined in terms of names and decimal places.



Note

The assignment of values to fields **CANNOT** be changed.

Example: the "Flow" field will **ALWAYS** issue the flow value even if it has been renamed to "Temperature".

The highlight colours of the output fields correspond with the colours of the values as indicated on the main screen (see Fig. 27-2).

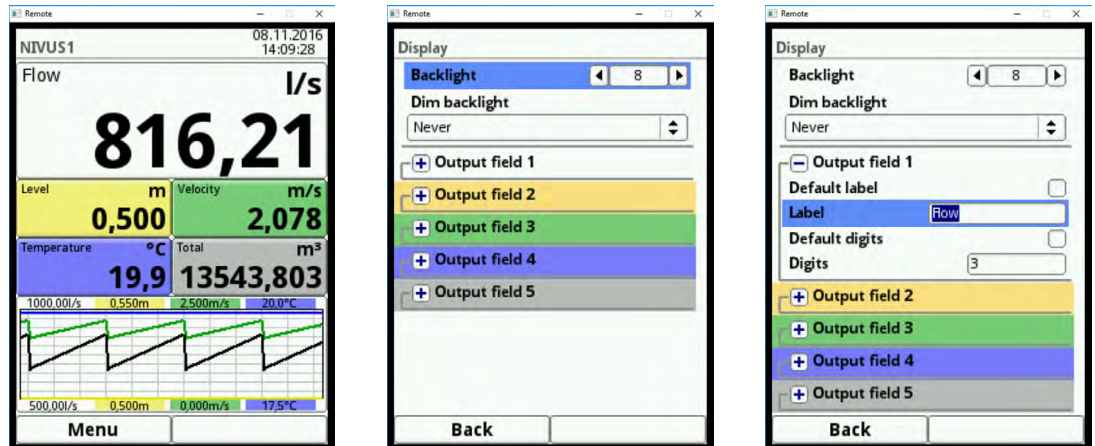

Fig. 27-2 Output fields, colours and settings

➡ Renaming procedure:

1. Unfold the output field.
2. Untick >Standard Name<.
3. Enter a new name. This name can be chosen freely. The length of the name is limited to 16 characters.
The name entered **does not** change the values on the main screen.

The same procedure can be used to specify the desired **number of decimal digits**. Here a maximum of five decimal digits is possible.



Note

During setting the decimal digits observe the measurement accuracies of the sensors and the measurement units set.

The temperature sensor e. g. has a maximum resolution of 0.1 K.

28 Connections

This submenu is required as soon as flow velocity sensors are not directly connected to the transmitter but by using the type iXT Ex Separator Module.

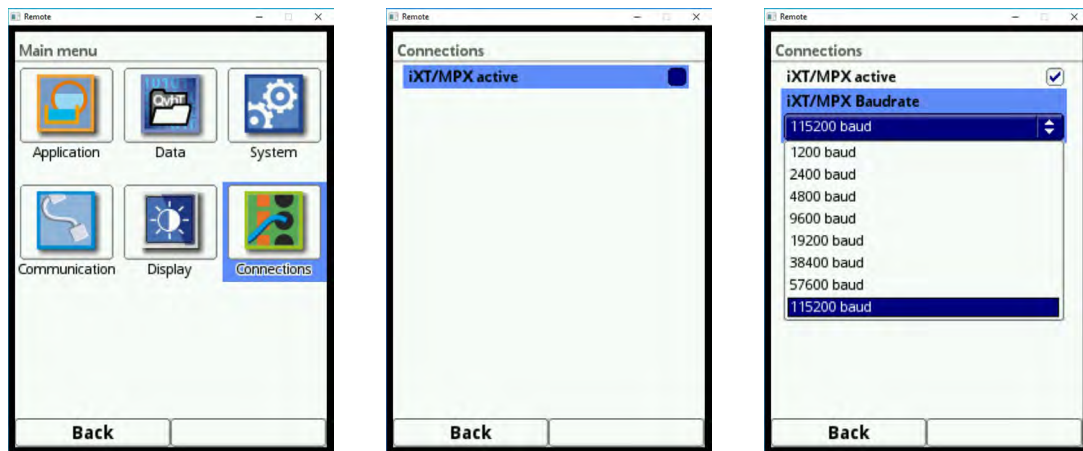

Fig. 28-1 Select connections/activation/baud rate

If an iXT is used tick this option in the selection field since otherwise sensor and module will not be recognised.

The **baud rate** can be adjusted here too.

Default setting: 115 200 baud.

Main Display

Quick access

You can directly access the main setup parameters by using the Main screen.

29 General overview

The following information can be found in the **top display line**:

- Name of measurement place
- Date
- Time

The red full circle with white cross in the top display line indicates current malfunctions of system or individual sensors.

When in operation mode, the NivuFlow indicates the following important readings in the **main display sector**:

- Flow quantity
- Fill level
- Velocity (calculated average flow velocity)
- Medium temperature
- Sum

The **bottom line** of the display shows a trend graph (hydrograph) as well as the current functions of both function keys.

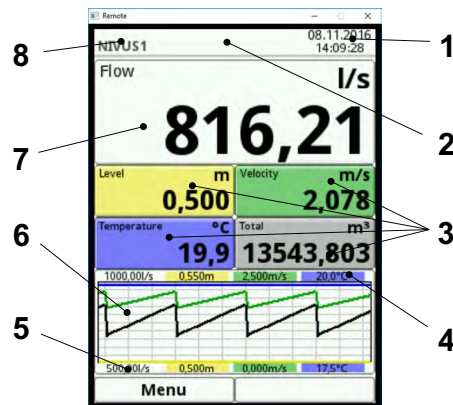

- 1 Date/Time
- 2 Error message (if pending)
- 3 Display for single measurement values
- 4 Upper scaling range
- 5 Lower scaling range
- 6 Display hydrograph
- 7 Flow display
- 8 Name of measurement place

Fig. 29-1 Main screen

The menu allows to directly access the most relevant settings and information.

- Rotate the rotary pushbutton until the desired section is highlighted in black.
- Press the rotary pushbutton - the according section will open a dialogue window.

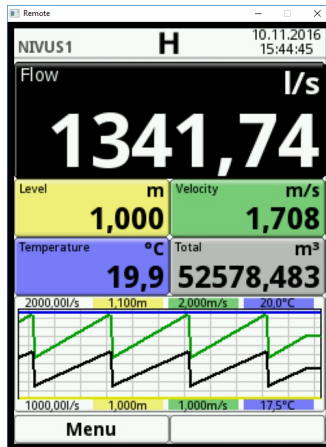

Fig. 29-2 Flow volume section selected



Note

After having modified the system-specific parameters, you need to confirm that the modifications are saved to activate the modified parameters.

29.1 Display Flow

You can access the individual sections (Settings, Diagnostics, Display and Error message) directly after the dialogue window is activated by pressing the rotary pushbutton.

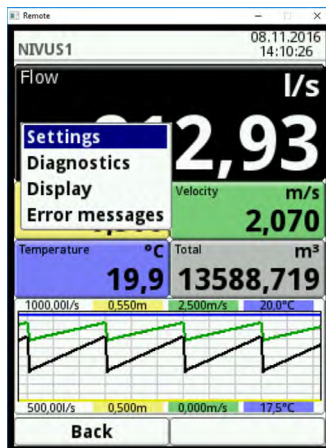

Fig. 29-3 Pop-up menu display Flow

29.1.1 Menu Settings (Flow)

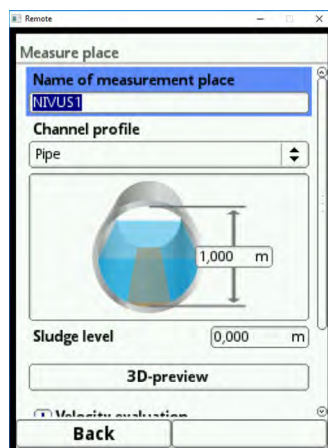

Fig. 29-4 Menu Settings (Flow)

The menu Settings (Flow) allows to directly access the measurement place settings below and to modify these parameter settings:

- Names
- Channel profile type and dimensions
- Sludge level input
- Low flow suppression
- Stability
- Damping

29.1.2 Menu Diagnostics (Flow)

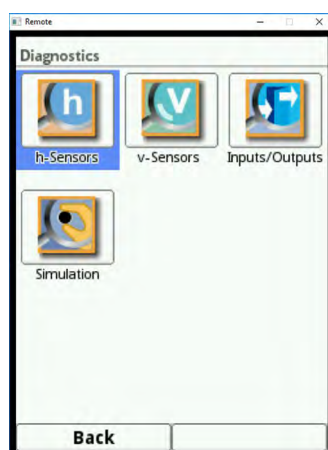

Fig. 29-5 Menu Diagnostics (Flow)

By directly accessing the menu Diagnostics (Flow) you can instantly carry out verifications within the limits of the application programmed:

- Connected sensors
- Physical condition of analog and digital inputs
- Output command to the analog and digital inputs
- Simulation of any flow value
- Indication of the prevailing flow profile

29.1.3 Menu Display (Flow)



Fig. 29-6 Menu Display (Flow)

The menu Display (Flow) allows to directly access the settings below and to modify these parameter settings:

- Dim the backlight
- Change the words of the five output fields
- Decimal places of measurement values

29.1.4 Menu Error messages (Flow)

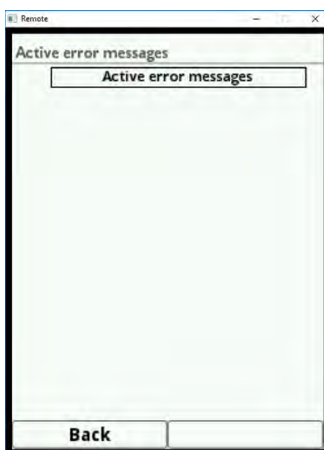

Fig. 29-7 Menu Error messages (Flow)

The table indicating the wording of the current error message will come up as soon as the >Error messages< option is activated.

29.2 Display Level

You can access the individual sections (Settings, Diagnostics and Display) directly after the dialogue window is activated by pressing the rotary pushbutton.

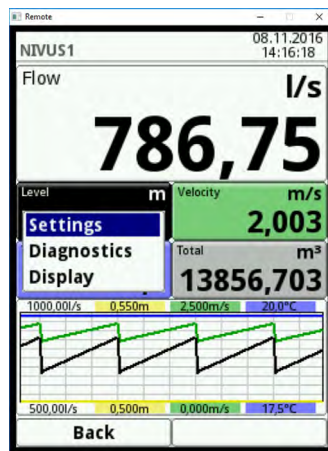

Fig. 29-8 Pop-up menu display Level

29.2.1 Menu Settings (Level)

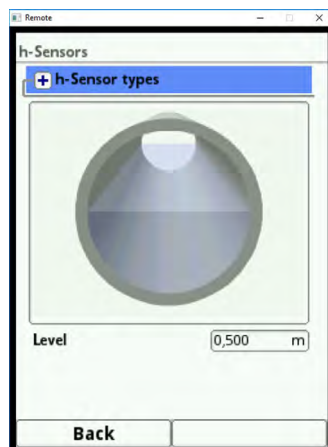

Fig. 29-9 Menu Settings (Level)

The menu Settings (Level) allows to pick the individual level sensors.

29.2.2 Menu Diagnostics (Level)

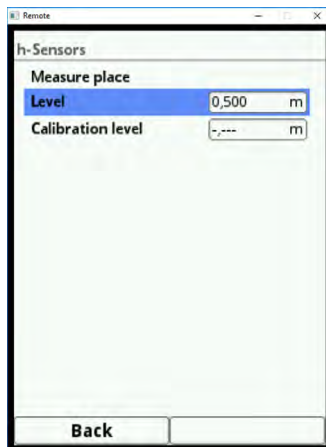

Fig. 29-10 Menu Diagnostics (Level)

The menu Diagnostics (Level) shows the basic level sensor information:

- Firmware version
- Article number
- Serial number

The current echo profiles of used NIVUS ultrasonic sensors can be assessed here.

29.2.3 Menu Display (Level)

The menu Display (Level) is the same than the the menu Display (Flow). See chapter „29.1.3 Menu Display (Flow)“.

29.3 Display Velocity

You can access the individual sections (Settings, Diagnostics and Display) directly after the dialogue window is activated by pressing the rotary pushbutton.

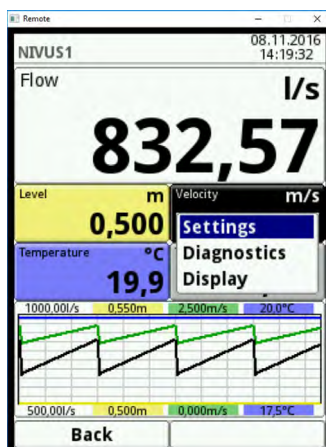

Fig. 29-11 Pop-up menu display Velocity

29.3.1 Menu Settings (Velocity)



Fig. 29-12 Menu Settings (Velocity)

The menu Settings (Velocity) allows to pick the individual flow velocity sensors. The following parameters can be set:

- Settings of the programmed flow velocity sensors
- Sensor constructions
- Installation positions and directions
- Correct reviews
- Modify limitations of flow evaluation

29.3.2 Menu Diagnostics (Velocity)



Fig. 29-13 Menu Diagnostics (Velocity)

The dialog shows:

- Article no. and serial no. of individual sensors
- Firmware version of individual sensors
- Calculated average flow velocity

29.4 Display Temperature and Sum

Flow velocity sensor 1 is equipped with a **temperature sensor**, from which the temperature is read out and indicated automatically.

The **sum** is calculated mathematically using the current flow volume integrated during a certain period. That is why both values neither can be edited nor can they be used for diagnostic options. Selecting temperature or sum takes you back to the general display menu (see chapter „29.1.3 Menu Display (Flow)“).

29.5 Display Trend/Hydrograph



Fig. 29-14 Display Trend/Hydrograph

If more comprehensive and in-depth graphs should be required, the graph section can be selected directly.

Here you can specify display period as well as the display range.

The >browse< function is located below the display. Browse next or back within the selected period using the arrow keys.

Diagnosis

30 Basics of Diagnosis Menus

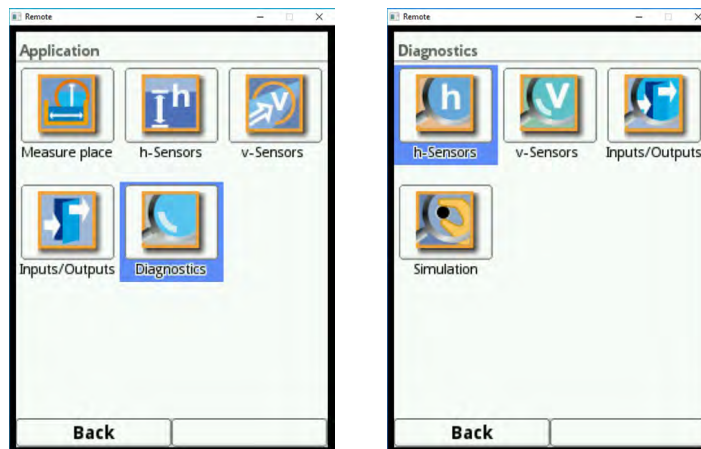

Fig. 30-1 Diagnosis menu

The >Diagnosis< menu can be found in menu >Application< and is divided into four sub-menus.

The Diagnosis menu and all submenus are pure read-only and simulation menus.

In this section the following settings can be verified or simulated:

- h-Sensors (level and adjustment height)
- v-Sensors (article no., firmware version, serial no. and velocity)
- Inputs and outputs (status and simulation)
- Simulation



Important Note

Always follow the safety information on simulation on page 117.

31 Diagnosis h-Sensors



Fig. 31-1 Diagnosis menu h-sensors

This menu has a relation to the menu >Applications</>h-Sensors<. Depending on the type and number of sensors defined here the sections are indicated in the corresponding colours.

➡ See chapter „23.2 Setting Parameters in h-Sensors Menu“

The Diagnosis indicates the current level in an unchangeable state. The adjustment height can be set and must be confirmed with OK (Fig. 31-1). The adjustment height is equal to the offset and is normally specified when the h-sensor parameters are set.

Depending on which sensors are selected the value, the calibrated value or the raw value are indicated.

- **Value:** issued value
- **Calibrated value:** corrected used value
- **Raw value:** real measured value

Furthermore the ring-down behaviour can be viewed by using the “Diagnostics” button.

32 Diagnosis v-Sensors



Fig. 32-1 Menu radar sensor diagnosis

This menu is used to view information on hardware and current sensor data (see Fig. 32-1).
Information details:

- Article No., firmware version and serial no. (important to customer service in case of requests)
- Velocity (numeric)

33 Inputs and Outputs (Analog and Digital)

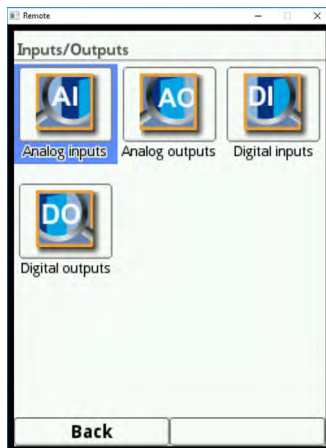

Fig. 33-1 Inputs/Outputs menu

➡ See also chapter „23.4 Inputs and Outputs (analog and digital)“.

33.1 Analog Inputs

This menu is to indicate the voltage values and measurement values (assigned by using the measurement span) available on the analog inputs of the transmitter.



Fig. 33-2 Screen analog input values

33.2 Analog Outputs

This menu is to indicate the calculated voltage values and measurement values (assigned by using the measurement span) to be issued at the analog converter.

Moreover it is possible to simulate the analog values.



Fig. 33-3 Screen analog output values



Note

This screen shows only the signals received by the analog converter to be issued. The real flowing currents are not issued.

External faulty wiring cannot be indicated in this menu.

This menu provides a simulation of the individual analog outputs.



Fig. 33-4 Password-protected simulation

DANGER**Personal injury or property damage**

The simulation of analog outputs shall be executed by trained electricians only. The responsible expert personnel must have sound knowledge on the entire control procedures of the according facility.

Prepare the simulation process carefully:

- Switch the following systems to manual operation.
- Disable actuating drives and similar or limit the according function.

It is absolutely necessary to have a safety person available!

Disregarding may lead to personal injury or damage your facility.

NIVUS herewith in advance refuse any responsibility for any possible damage to persons or objects at any extent due to the extremely high risk of danger and unforeseeable consequences in the event of incorrect or faulty simulation!

DANGER**Effects on plant sections**

The simulation of NivuFlow outputs will directly affect any following plant sections without any safety locking measures!

Simulations are allowed to be executed exclusively by qualified expert personnel. Observe the hints contained within the above warning!

**Note**

Due to the reasons of safety mentioned before the simulation mode access is password-protected.

Due to reasons of personal safety share your password only with authorised and trained expert personnel!

➡ To simulate an analog output proceed as follows:

1. Enter your password.
2. Turn the rotary-pushbutton until the desired analog output is highlighted blue.
3. Press the rotary-pushbutton to activate (tick) the analog output.
4. Then specify the desired output current as numeric value. Observe that the analog output(s) will provide the specified voltages until the simulation is stopped.
5. Press the left function key to exit the simulation menu.

33.3 Digital Inputs

This menu shows the signals oncoming on the digital inputs. Active digital inputs are ticked.



Fig. 33-6 Screen digital inputs

33.4 Digital Outputs

The adjusted digital output values are indicated here.



Fig. 33-7 Screen digital outputs

A simulation of digital outputs is available in this menu too.



Fig. 33-8 Password-protected simulation

DANGER**Personal injury or property damage**

The simulation of analog outputs shall be executed by trained electricians only. The responsible expert personnel must have sound knowledge on the entire control procedures of the according facility.

Prepare the simulation process carefully:

- Switch the following systems to manual operation.
- Disable actuating drives and similar or limit the according function.

It is absolutely necessary to have a safety person available!

Disregarding may lead to personal injury or damage your facility.

NIVUS herewith in advance refuse any responsibility for any possible damage to persons or objects at any extent due to the extremely high risk of danger and unforeseeable consequences in the event of incorrect or faulty simulation!

DANGER**Effects on plant sections**

The simulation of NivuFlow outputs will directly affect any following plant sections without any safety locking measures!

Simulations are allowed to be executed exclusively by qualified expert personnel. Observe the hints contained within the above warning!

**Note**

Due to the reasons of safety mentioned before the simulation mode access is password-protected.

Due to reasons of personal safety share your password only with authorised and trained expert personnel!

➡ To simulate a digital output proceed as follows:

1. Enter your password.
2. Turn the rotary-pushbutton until the desired digital output is highlighted blue.
3. Press the rotary-pushbutton to activate (tick) the digital output.
4. Then specify the desired output current as numeric value. Observe that the digital output(s) will provide the specified voltages until the simulation is stopped.
5. Press the left function key to exit the simulation menu.

The simulation of each output can be activated in the same manner.

34 Simulation

This menu can be used to simulate theoretical flow. Simulation is executed by specifying assumed values for levels and velocities. These values are not available in reality, however. Using this simulated values the transmitter calculates the prevailing flow rate based on the dimensions of the programmed channel.

This value is issued on the analog or digital outputs determined before.



Fig. 34-1 Enter password

DANGER



Personal injury or property damage

The simulation of analog outputs shall be executed by trained electricians only. The responsible expert personnel must have sound knowledge on the entire control procedures of the according facility.

Prepare the simulation process carefully:

- Switch the following systems to manual operation.
- Disable actuating drives and similar or limit the according function.

It is absolutely necessary to have a safety person available!

Disregarding may lead to personal injury or damage your facility.

NIVUS herewith in advance refuse any responsibility for any possible damage to persons or objects at any extent due to the extremely high risk of danger and unforeseeable consequences in the event of incorrect or faulty simulation!

DANGER



Effects on plant sections

The simulation of NivuFlow outputs will directly affect any following plant sections without any safety locking measures!

Simulations are allowed to be executed exclusively by qualified expert personnel. Observe the hints contained within the above warning!



Note

Due to the reasons of safety mentioned before the simulation mode access is password-protected.

Due to reasons of personal safety share your password only with authorised and trained expert personnel!

➡ To start the simulation proceed as follows:

1. Enter your password.
2. Turn the rotary-pushbutton until the desired value to simulate (level or velocity) is highlighted blue.
3. Select the desired measurement value.
4. Confirm your selection with the right function key.
5. Press the left function key to exit the simulation menu.

The output box (see Fig. 34-2 Pos. 3) automatically shows the flow rate computed by considering both simulated values.

Digital and analog outputs possibly set behave as if they were actually programmed and will output these values effectively.

Issued signals and values are indicated on the display (see Fig. 34-2 Pos. 4 and 5).

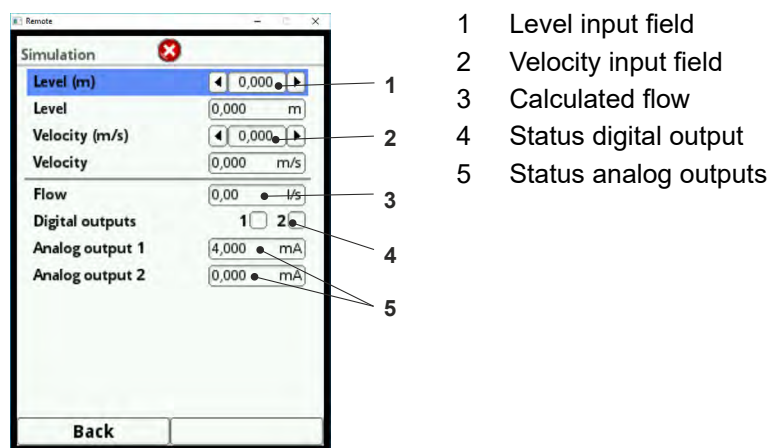

Fig. 34-2 Screen calculated values and issued states

Maintenance and Cleaning

WARNING



Disconnect instrument from mains

*Disconnect the instrument from mains power and safeguard the higher system against restart before you begin maintenance works.
Disregarding may lead to electric shocks.*

WARNING



Contamination by hazardous germs

Due to being frequently used in wastewater applications, some portions of the measurement system may be loaded with hazardous germs. This is why precautionary measures shall be taken while being in contact with the system, cables and sensors.

Wear protective clothing.

35 Maintenance

35.1 Maintenance interval

The Type NivuFlow transmitters are conceived to be virtually free of calibration, maintenance and wear (requirements of the Industrial Safety Regulations are unaffected.)

NIVUS recommends to have the entire measurement system inspected by the NIVUS customer service **once per year**.

Depending on the area of use the maintenance intervals however may vary.

Extent and intervals of maintenance depend on the following conditions:

- Measurement principle for Level Sensors
- Material wear
- Fluid and channel hydraulics
- General regulations for the operators of the measurement facility
- Ambient conditions

NIVUS recommends to have the measurement system completely be inspected by the manufacturer after **latest ten years**.

Generally the verification of instruments and sensors is a basic measure in order to improve operational reliability and to increase the lifetime.

35.2 Customer Service Information

For the recommended annual inspection of the entire measurement system and/or the extensive inspection after latest ten years contact our customer service:

NIVUS GmbH - Customer Service

Phone +49 (0) 7262 9191 - 922

Kundencenter@nivus.com

36 Cleaning

36.1 Transmitter

WARNING**Disconnect instrument from mains**

Disconnect the instrument from mains power before cleaning.

Disregarding may lead to electric shocks.

**Important information**

- Do not remove the **blue plastic rails** to clean the enclosure.
- Do not use the damp cloth to wipe over the **terminal clamp blocks**.

Clean the transmitter enclosure if required using a dry, lint-free cloth.

For stubborn dirt the enclosure can be cleaned using a damp cloth.

Do **not** use sharp cleansing agents or solvents. Light household cleaners or soapy water can be used.

36.2 Sensors

The hints on how to maintain and clean the sensors shall be necessarily observed. These hints can be found in the >Technical Instruction< and/or the >Instructor Manual<.

This (these) document(s) is (are) part of the standard sensor delivery.

37 Dismantling/Disposal

Improper disposal may be harmful to the environment.

- ➡ Always dispose equipment components and packaging materials according to applicable local regulations on environmental standards for electronic products:

1. Disconnect the unit from mains power.
2. Use appropriate tools to remove the connected cables from the faceplate of the instrument.
3. Remove the transmitter from the DIN rail.
4. Remove the backup battery and make sure that the backup battery will be disposed of separately.

**EC WEEE-Directive logo**

This symbol indicates that the Directive 2002/96/EG on waste electrical and electronic equipment requirements shall be observed on the disposal of the equipment.

The unit contains a buffer battery (Lithium coin cell), which must be disposed separately.

38 Accessories

iXT0-xxx	Intelligent Ex-Separator Module
ZUB0 USB 08	USB stick 8 GB for readout of parameter settings and measurement values using the NivuFlow USB interface
SW0N SPRO	Evaluation software, NivuSoft Professional with matched functions: documentation of measurement sites, output as graphs and tables, creation of statistics/reports etc.
BSL0xx	Overvoltage protection for measurement transmitters and sensors

You can find more accessories in the valid NIVUS price list.

Index

A

Abbreviations	12
Accessories	121
Accident level	
Valuation	15
Air temperature	
Analog output	71
Article number	24

B

Backlight	98
Basic menu	47
Baud rate	
Connections	100
Block V-measurement	
Digital input	73
Blue plastic cover strips	28
Buffer battery	120

C

Calming section	32
CE label	21
CFD	59
Change password	48
Chemicals	29
Colour code	12
Colour display	13
Communication	
HART	97
Modbus	97
TCP/IP	96
Web Server	96
Compress	86
Connection Diagram	40
Connections	12, 18
Contact protection	31
Control elements	13, 44
Tasks	13
Control Elements	20
Copyright	3
COSP	59
Customer Service	119

D

Damage in transit	24
Data depth	
Expert	85
Extended	85
Standard	85
Data format	
USB stick	84
Data memory	23
Date/Time Selection	79
Delivery	24
Device identification	21
Device setup	20
Disease germs	16
Display Overview	44
Disposal	120
Materials	18
Products	18
Doppler principle	26

E

EC WEEE-Directive logo	120
Electrostatic discharge	28
Error message	
Digital output	77
ESD	28
ESD risks	28
External measurement value	
Analog output	72

F

File name	86
Flow	
Analog output	71
Flow velocity	
Analog output	71
Function key	
left	13
right	14

G

Gases	29
-------------	----

H

HART	
Communication	97
Hazardous germs	119
Heavy shocks	25
Hotline	43
Humidity	23, 25

I

IEC 757	12
Impulse Counter	
Digital input	74
Installation Instructions	28
Installation place	28
Installation regulations	29
Instruction manual	24
Intended use	17
Interfaces	14, 20

K

Keypad	45
Numeric	46

L

Language	
Operation	90
Letter block	45
Level	
Analog output	71
Level sensors	
Selection	62
Liability	17
Limit Contact Flow	
Digital output	76
Limit Contact Level	
Digital output	76
Limit Contact Sludge	
Digital output	76
Limit Contact Velocity	
Digital output	76
Load Parameters	86
Low-voltage network	30

M

Main Menu	49
Max. power consumption	23
Measurement span	27
Modbus	
Communication	97
Modbus Slave	
Analog output	72
Digital output	78
Modifications	4

N

Nameplate	22
Names	3
Negative offset	27
Numeric keypad	46

O

Operating conditions	23
Operating temperature	23
Operation language	90
Ordering replacement parts	21
Original instruction	11
Original parts	25
Output fields	98
Overview	
product	20
Overvoltage category	23
Overvoltage protection elements	33

P

Parts subject to wear and tear	25
Period	80, 81
Period of transmission	
USB stick	84
Pollution degree	23
Precautions	16
Product construction	20
Property rights	3
Protection	23
Protection class	23
Protective conductor	12, 16
Protective Conductor Terminal	30

Q

Q suppressed	
Low flow volumes	60
Qualified personnel	19, 43

R

Radar-Doppler effect	26
Radar measurement method	26
Radioactive radiation	29
RCD	29
Reception inspection	24
Recording	
Digital Inputs	74
Regulations on environmental standards	120
Reset	
Measurement	95
Parameter	96
Residual-current-operated protective device	29
Restart	
Measurement	95
System	95
Return	25
Revision of parameters	47
Rotary pushbutton	
Tasks	13
Runtime	
Digital input	74

S

Safety Instructions	15
Save Parameters	86
Sensors	24
connectable	21
Sensor velocity	
Analog output	72
Signal words	15
Sludge level	
Analog output	72
SNTP	
Time server	93
Spare parts	25
Specifications	23
Storage cycle	23, 88
Storage temperature	23
Sum impulses	
Digital output	75

Sunlight	28
Supply connection	23
Surface Radar	26
Symbols	15
System time	93

T

TCP/IP	
Communication	96
Temperature	25
Theoretical flow	
Simulation	117
Time zone	93
Totalising events	82
Trademarks	3
Translation	3
Transport	25
Trend graph	101

U

Units system	91
Use in accordance with the requirements	17
User elements	12
User's Responsibilities	18

V

Vibrations	25
v suppressed	
Low flow volumes	60

W

Warning notices on the product	16
Waste	120
Water temperature	
Analog output	71
Web Server	
Communication	96
Wire cross section	39

EU Konformitätserklärung

EU Declaration of Conformity

Déclaration de conformité UE

Für das folgend bezeichnete Erzeugnis:

For the following product:

Le produit désigné ci-dessous:

Bezeichnung:	Durchflussmessumformer stationär mit internem 2G/3G/4G Modem zur Datenfernübertragung NivuFlow 5xx
<i>Description:</i>	<i>Permanent flow measurement transmitter with internal modem for remote data transmission</i>
<i>Désignation:</i>	<i>Transmetteur de débit stationnaire avec modem intégré pour transmission de données</i>
Typ / Type:	NF5-...

erklären wir in alleiniger Verantwortung, dass die auf dem Unionsmarkt ab dem Zeitpunkt der Unterzeichnung bereitgestellten Geräte die folgenden einschlägigen Harmonisierungsvorschriften der Union erfüllen:

we declare under our sole responsibility that the equipment made available on the Union market as of the date of signature of this document meets the standards of the following applicable Union harmonisation legislation:

nous déclarons, sous notre seule responsabilité, à la date de la présente signature, la conformité du produit pour le marché de l'Union, aux directives d'harmonisation de la législation au sein de l'Union:

- 2014/53/EU
- 2011/65/EU

Bei der Bewertung wurden folgende einschlägige harmonisierte Normen zugrunde gelegt bzw. wird die Konformität erklärt in Bezug auf die nachfolgend genannten anderen technischen Spezifikationen:

The evaluation assessed the following applicable harmonised standards or the conformity is declared in relation to other technical specifications listed below:

L'évaluation est effectuée à partir des normes harmonisées applicable ou la conformité est déclarée en relation aux autres spécifications techniques désignées ci-dessous:

- EN 61010-1:2010 + A1:2019 + A1:2019/AC:2019
- EN 61326-1:2013
- Draft ETSI EN 301 489-52 V1.2.1
- EN 301 908-1 V15.2.0 (UMTS/3G, LTE/4G)
- EN 301 908-13 V13.2.1 (LTE/4G)
- EN 62311:2008
- EN 301 489-1 V2.2.3
- EN 301 511 V12.5.1 (GSM/2G)
- EN 301 908-2 V13.1.1 (UMTS/3G)

Diese Erklärung wird verantwortlich für den Hersteller:

This declaration is submitted on behalf of the manufacturer:

Le fabricant assume la responsabilité de cette déclaration:

NIVUS GmbH
Im Täle 2
75031 Eppingen
Germany

abgegeben durch / represented by / faite par:

Ingrid Steppe (Geschäftsführerin / *Managing Director / Directeur général*)

Eppingen, den 20.10.2022

Gez. *Ingrid Steppe*

UK Declaration of Conformity

NIVUS GmbH
Im Tale 2
75031 Eppingen

Telefon: +49 07262 9191-0
Telefax: +49 07262 9191-999
E-Mail: info@nivirus.com
Internet: www.nivirus.de

For the following product:

Description:	Permanent flow measurement transmitter with internal modem 2G/3G/4G for remote data transmission NivuFlow 5xx
Type:	NF5-...

we declare under our sole responsibility that the equipment made available on the UK market as of the date of signature of this document meets the standards of the following applicable UK harmonisation legislation:

- SI 2017 / 1206 The Radio Equipment Regulations 2017
- SI 2012 / 3032 The Restriction of the Use of Certain Hazardous Substances in Electrical and Electronic Equipment Regulations 2012

The evaluation assessed the following applicable harmonised standards or the conformity is declared in relation to other technical specifications listed below:

- BS EN 61010-1:2010 + A1:2019 + A1:2019/AC:2019
- BS EN 61326-1:2013
- Draft ETSI EN 301 489-52 V1.2.1
- BS EN 301 908-1 V15.2.0 (UMTS/3G, LTE/4G)
- BS EN 301 908-13 V13.2.1 (LTE/4G)
- BS EN 62311:2008
- BS EN 301 489-1 V2.2.3
- BS EN 301 511 V12.5.1 (GSM/2G)
- BS EN 301 908-2 V13.1.1 (UMTS/3G)

This declaration is submitted on behalf of the manufacturer:

NIVUS GmbH
Im Tale 2
75031 Eppingen
Germany

represented by:

Ingrid Steppe (Managing Director)

Eppingen, 20/10/2022

Signed by *Ingrid Steppe*

EU Konformitätserklärung

EU Declaration of Conformity

Déclaration de conformité UE

NIVUS GmbH
Im Täle 2
75031 Eppingen

Telefon: +49 07262 9191-0
Telefax: +49 07262 9191-999
E-Mail: info@nivus.com
Internet: www.nivus.de

Für das folgend bezeichnete Erzeugnis:

For the following product:

Le produit désigné ci-dessous:

Bezeichnung:	Durchflussmessumformer stationär NivuFlow 550
<i>Description:</i>	<i>permanent flow measurement transmitter</i>
<i>Désignation:</i>	<i>convertisseur de mesure de débit fixe</i>
Typ / Type:	NF5-...

erklären wir in alleiniger Verantwortung, dass die auf dem Unionsmarkt ab dem Zeitpunkt der Unterzeichnung bereitgestellten Geräte die folgenden einschlägigen Harmonisierungsvorschriften der Union erfüllen:

we declare under our sole responsibility that the equipment made available on the Union market as of the date of signature of this document meets the standards of the following applicable Union harmonisation legislation:

nous déclarons, sous notre seule responsabilité, à la date de la présente signature, la conformité du produit pour le marché de l'Union, aux directives d'harmonisation de la législation au sein de l'Union:

- 2014/30/EU
- 2014/35/EU
- 2011/65/EU

Bei der Bewertung wurden folgende einschlägige harmonisierte Normen zugrunde gelegt bzw. wird die Konformität erklärt in Bezug die nachfolgend genannten anderen technischen Spezifikationen:

The evaluation assessed the following applicable harmonised standards or the conformity is declared in relation to other technical specifications listed below:

L'évaluation est effectuée à partir des normes harmonisées applicable ou la conformité est déclarée en relation aux autres spécifications techniques désignées ci-dessous:

- EN 61326-1:2013
- EN 61010-1:2010 + A1:2019 + A1:2019/AC:2019

Diese Erklärung wird verantwortlich für den Hersteller:

This declaration is submitted on behalf of the manufacturer:

Le fabricant assume la responsabilité de cette déclaration:

NIVUS GmbH
Im Täle 2
75031 Eppingen
Allemagne

abgegeben durch / *represented by / faite par:*

Ingrid Steppe (Geschäftsführerin / *Managing Director / Directeur général*)

Eppingen, den 20.10.2022

Gez. *Ingrid Steppe*

UK Declaration of Conformity

NIVUS GmbH
Im Tale 2
75031 Eppingen

Telefon: +49 07262 9191-0
Telefax: +49 07262 9191-999
E-Mail: info@nivirus.com
Internet: www.nivirus.de

For the following product:

Description:	Permanent flow measurement transmitter NivuFlow 550
Type:	NF5-...

we declare under our sole responsibility that the equipment made available on the UK market as of the date of signature of this document meets the standards of the following applicable UK harmonisation legislation:

- SI 2016 / 1091 The Electromagnetic Compatibility Regulations 2016
- SI 2016 / 1101 The Electrical Equipment (Safety) Regulations 2016
- SI 2012 / 3032 The Restriction of the Use of Certain Hazardous Substances in Electrical and Electronic Equipment Regulations 2012

The evaluation assessed the following applicable harmonised standards or the conformity is declared in relation to other technical specifications listed below:

- BS EN 61326-1:2013
- BS EN 61010-1:2010 + A1:2019 + A1:2019/AC:2019

This declaration is submitted on behalf of the manufacturer:

NIVUS GmbH
Im Taele 2
75031 Eppingen
Germany

represented by:

Ingrid Steppe (Managing Director)

Eppingen, 20/10/2022

Signed by *Ingrid Steppe*