

Technical Description for Pressure and Level Probes: AquaBar BS, AquaBar II and UniBar E II



Revised Instruction Manual

Document Revision 10 / 22.12.2022

Original Instruction Manual: German / Rev. 10 as of 29.11.2022

measure analyse optimise

NIVUS AG

Burgstrasse 28
8750 Glarus, Switzerland
Phone +41 55 6452066
Fax +41 55 6452014
swiss@nivus.com
www.nivus.com

NIVUS Austria

Mühlbergstraße 33B
3382 Loosdorf, Austria
Phone +43 2754 5676321
Fax +43 2754 5676320
austria@nivus.com
www.nivus.com

NIVUS Sp. z o.o.

ul. Hutnicza 3 / B-18
81-212 Gdynia, Poland
Phone +48 58 7602015
Fax +48 58 7602014
biuro@nivus.pl
www.nivus.pl

NIVUS France

12 rue Principale
67870 Bischoffsheim, France
Phone +33 388 999284
info@nivus.fr
www.nivus.fr

NIVUS Ltd., United Kingdom

Furzen Hill Farm
Coventry Road, Cubbington
Royal Leamington Spa
CV32 7UJ, Warwickshire
Phone +44 8445 332883
nivusUK@nivus.com
www.nivus.com

NIVUS Middle East (FZE)

Prime Tower
Business Bay Dubai
31st floor, office C-3
P.O. Box: 112037
Phone +971 4 4580502
middle-east@nivus.com
www.nivus.com

NIVUS Korea Co. Ltd.

#2301 M-Dong Technopark IT Center,
32 Songdogwahak-ro, Yeonsu-gu,
INCHEON, Korea 21984
Phone +82 32 2098588
Fax +82 32 2098590
jhwon@nivuskorea.com
www.nivuskorea.com

NIVUS Vietnam

238/78 Phan Trung Street,
Tan Tien Ward, Bin Hoa City,
Dong Nai Province, Vietnam
Phone +84 94 2623979
jhwon@nivuskorea.com
www.nivus.com

Copyrights and Property Rights

The contents of this document including tables and drawings are proprietary to NIVUS GmbH and are not to be reproduced or copied without express written permission.

Violations oblige to compensation.



Important

This instruction manual - even in parts - may exclusively be copied or translated in any other way with the express written consent of NIVUS GmbH.

Translation

If the device is sold to a country in the European Economic Area this instruction manual must be translated into the language of the country in which the device is to be used.

Should the translated text be unclear, the original instruction manual (German) must be consulted or a member company of the NIVUS-Group must be contacted for clarification.

Copyright

No part of this publication may be reproduced, transmitted, sold or disclosed without prior permission. All rights reserved.

Names

The use of general descriptive names, trade names, trademarks and the like in this manual does not entitle the reader to assume they may be used freely by everyone. They are often protected registered trademarks even if not marked as such.

Revision History

Rev.	Modifications	Respon- sible Editor	Date
10	Outsourcing of the contents for AquaBar BS, AquaBar II and UniBar E II from the Instruction Manual for Pressure and Level Probes: NivuBar Plus II, NivuBar G II, NivuBar H III, HydroBar G II, UniBar E II, AquaBar / Rev. 09 / 12.10.2017; Updated contents (incl. certificates) and layout	MoG	22.12.2022
1 - 9	See release form of instruction manual for Pressure and Level probes: NivuBar Plus II, NivuBar G II, NivuBar H III, HydroBar G II, UniBar E II, AquaBar / Rev. 09 / 12.10.2017	--	Various

Table of Contents

<u>Copyrights and Property Rights</u>	3
<u>Revision History</u>	4
<u>Table of Contents</u>	5
<u>General</u>	7
1 About this Manual	7
1.1 Applicable Documentation	7
1.2 Signs and Definitions used	8
<u>Safety Instructions</u>	9
2 Used Symbols and Signal Words	9
2.1 Information on the Valuation of Accident Levels	9
2.2 Warning Notices on the Device (optional)	10
3 Special Safety and Precautionary Measures	11
4 Warranty	11
5 Disclaimer	12
6 Intended Use	13
7 Ex Protection	13
8 Duties of the Operator	15
9 Requirements for the Personnel	16
<u>Delivery, Storage and Transport</u>	17
10 Scope of Delivery	17
11 Inspection upon Receipt	17
12 Storage	17
13 Transport	17
14 Return	18
<u>Product Description</u>	19
15 Overview and Use	19
16 Designs	20
17 Device ID	21
18 Specifications	22
19 Device Versions	24

Function Description	27
20 Functional Principle	27
20.1 General	27
Installation, Mounting and Connection	28
21 General Installation Instructions	28
22 Installation	28
22.1 General	28
22.2 Dimensions	30
23 Connection	34
23.1 Connector Pin Assignment	36
23.2 Wiring	36
23.3 Supply Voltage	37
Commissioning	38
Maintenance and Cleaning	39
24 Maintenance	39
24.1 Maintenance Interval	39
24.2 Customer Service Information	39
25 Cleaning	40
26 Dismantling/Disposal	41
27 Installation of Spare Parts and Wearing Parts	41
Index	42
Certificates and Approvals	43

General

1 About this Manual

**Important**

READ CAREFULLY BEFORE USE.

KEEP IN A SAFE PLACE FOR LATER REFERENCE.

This instruction manual is for the pressure and level probes and serves their intended use. This instruction manual is oriented exclusively to qualified expert personnel.

Read this instruction manual carefully and completely prior to installation or connection since it contains relevant information on this product. Observe the notes and particularly follow the warning notes and safety instructions.

If you should have problems to understand information contained within this instruction manual either contact a member company of the NIVUS-Group or one of the distributors for further support. The member companies of the NIVUS-Group cannot be held responsible for damage to persons or material due to incorrectly understood information in this instruction.

The description of the operation of the pressure and level probes with a NIVUS transmitter is written in the corresponding instruction manual of the transmitter.



1.1 Applicable Documentation

For the installation and operation of the complete system extra instruction manuals or technical descriptions listed below may be required in addition to this technical description.

- Instruction Manual for NivuFlow Mobile xxx or NivuLevel Mobile
- Instruction Manual for the NivuCont Plus transmitter
- Instruction Manual for the NivuCont S transmitter

These manuals are provided with the respective (auxiliary) units or sensors and/or are available as download on the NIVUS homepage.

1.2 Signs and Definitions used

Representation	Meaning	Remarks
	(Action) Step	Execute action steps. Should action steps be numbered observe the specified order of the steps.
	Cross-reference	Refers to further or more detailed information.
	Refers to a documentation	Refers to an accompanying documentation.
>Text<	Parameter or menu	Indicates a parameter or a menu that is to be selected or is described.

Tab. 1 Structural elements within the manual

Safety Instructions

2 Used Symbols and Signal Words

2.1 Information on the Valuation of Accident Levels



The general warning symbol indicates the risk of personal injuries or death. In the text section the general warning symbol is used in combination with the signal words described below.

DANGER

Warning in high degree of risk



*Indicates a high-risk, **imminently** hazardous situation which will result in death or serious injury if not avoided.*

WARNING

Warning in medium degree of risk and personal injury



*Indicates a **possible** danger with medium risk which may result in a life-threatening situation or (severe) bodily injury if not avoided.*

CAUTION

Warning in personal injury or property damage



Indicates a possible danger with moderate risk which may result in minor or moderate personal injury or property damage if not avoided.

WARNING

Danger by electric voltage



*Indicates a medium-risk, **imminently** hazardous situation caused by electric shock which will result in death or (serious) injury if not avoided.*

**Important Note**

Contains information that needs to be highlighted.

Indicates a potentially harmful situation that may damage the product or something in its environment if not avoided.

**Note**

Contains tips or information.

2.2 Warning Notices on the Device (optional)

**General Warning Notice**

This symbol refers the operator or user to content in this manual.

Consideration of the information contained herein is necessary to maintain the protection provided by the unit for installation and in operation.

**Protective earth connection**

This symbol refers to the protective conductor terminal of the device.

Depending on the type of installation, the unit may only be operated with a suitable protective earth connection in accordance with applicable laws and regulations.

3 Special Safety and Precautionary Measures

WARNING *Germ Contamination*



Due to the frequent use of the sensors in the waste water sector, parts can be contaminated with dangerous germs. Therefore, appropriate precautions must be taken when coming into contact with cables and sensors.

Wear protective clothing.

WARNING *Observe Occupational Safety Regulations!*



Before and during mounting works, compliance with all work safety regulations must always be ensured.

Disregarding may lead to personal injury.

WARNING *Do not disable Safety Devices!*



It is strictly forbidden to disable the safety devices or to change their mode of operation.

Disregarding may result in personal injury or damage to the system.



Commissioning only by qualified Personnel

The entire measuring system may only be installed and commissioned by qualified personnel.

4 Warranty

The device was functionally tested prior to shipping. When used for the intended purpose (see Chap. "6 Intended Use") and in compliance with the instructions, the applicable documents (see Chap. "1.1 Applicable Documentation") and the safety information and instructions contained therein, no functional restrictions are to be expected and flawless operation should be possible.



Please also refer to the following chapter "5 Disclaimer".



Limitation of Warranty

In case of disregarding the safety notes and instructions in this document, the companies of the NIVUS-Group reserve the right to limit the warranty.

5 Disclaimer

The companies of the NIVUS-Group assume no liability

- for consequential damages resulting from a change in this document. The companies of the NIVUS-Group reserve the right to change the contents of the document including this disclaimer without prior notice.
- for personal injury or damage to property resulting from **failure to comply** with the **applicable regulations**. For connection, commissioning and operation of the devices, all information and higher-level legal regulations of the country (in Germany e.g. the VDE regulations), such as valid Ex regulations as well as the safety and accident prevention regulations applicable to the respective individual case shall be observed.
- for personal injury or damage to property resulting from **improper handling**. For safety and warranty reasons, all work on the equipment that goes beyond the installation and connection measures may only be carried out by NIVUS personnel or by persons or companies authorised by NIVUS.
- for personal injury or damage to property resulting from the operation of the equipment in a **technically faulty** condition.
- for personal injury or damage to property resulting from **improper use**.
- for personal injury or damage to property resulting from failure to observe the **safety instructions** in this instruction manual.
- for missing or incorrect readings due to **improper installation** and for any consequential damage resulting therefrom.

6 Intended Use



Note

The device is intended exclusively for the purpose mentioned below. Any other use beyond this, any conversion or modification of the instrument without written agreement with the companies of the NIVUS-Group is considered improper use.

The companies of the NIVUS-Group are not liable for any damage resulting from this.

The operator alone bears the risk.

The probes are used for pressure and level measurements (depending on their type as immersion or screw-in probe).

The pressure and level probes are designed and produced according to the current state of the art and the recognised safety rules at the time of publication of this document. Nevertheless, risks of personal injury or damage to property cannot be completely ruled out.

The permissible maximum limit values in Chapter "18 Specifications" must be observed. All cases of use deviating from these limit values, which have not been approved by NIVUS GmbH in writing, are excluded from the liability of the NIVUS-Group.

7 Ex Protection

The probes partly are designed for use in areas with explosive atmospheres of zone 0.





Observe EU Type Examination Certificate Point 17

Point [17] of the respective Ex Certificate/EU Type Examination Certificate specifies special conditions for intrinsically safe operation.

Approval

AquaBar II, UniBar E II

 II 1G Ex ia IIC/IIB T4 Ga

 II 1D Ex ia IIIC T135°C Da

Approval Number:

IBEXU11ATEX1046X Edition 2

$U_i = 28 \text{ V}$

$I_i = 93 \text{ mA}$

$P_i = 660 \text{ mW}$

$C_i = \text{negligible}$

$L_i = \text{negligible}$

Plus line inductances $1 \mu\text{H/m}$ and line capacitances 100 pF/m (with factory cable).

The supply terminals have an internal capacitance of max. 27 nF relative to the housing.

Tab. 2 **Data relevant for approval**

DANGER



Explosion hazard due to zone entrainment

Make the cable duct from the probe to the transmitter gas-tight.

To prevent zone entrainment, probes with 1/2G approval must be installed gas-tight in the zone separation wall.

Otherwise there is a risk of explosion.



Validity of the Ex Approval

The Ex approval is only valid in conjunction with the corresponding marking on the nameplate of the sensors.



Declarations of Conformity and Test Certificates

In case of disregarding the safety notes and instructions in this document, the companies of the NIVUS-Group reserve the right to limit the warranty.

8 Duties of the Operator



Important Note

In the EEA (European Economic Area), the national transposition of the Framework Directive (89/391/EEC) as well as the associated individual directives and, in particular, the Directive (2009/104/EC) concerning the minimum safety and health requirements for the use of work equipment by workers at work, as amended, must be observed and complied with.

In Germany, the Ordinance on Industrial Safety and Health must be complied with.

Obtain the local operating licence and observe the associated conditions. In addition, you must comply with environmental protection requirements and local legal requirements for the following:

- Safety of personnel (accident prevention regulations)
- Safety of work equipment (protective equipment and maintenance)
- Product Disposal (Waste Management Act)
- Materials Disposal (Waste Management Act)
- Cleaning (Cleaning Agents and Disposal)

Connections

As the operator, before activating the pressure/level probes, make sure that the local regulations (e.g. for the electrical connection) have been observed during installation and commissioning.

Keep the Instruction Manual for future Reference

Keep the instruction manual in a safe place and ensure that it is always available and can be consulted by the user of the product.

Hand over the Instruction Manual

When selling the pressure/level probes, this instruction manual must be handed over with them. The manual is part of the standard delivery.

9 Requirements for the Personnel

Installation, commissioning and maintenance may only be carried out by personnel who fulfil the following conditions:

- Qualified personnel with appropriate training
- Authorisation by plant operator



Qualified Personnel

in the sense of these instructions or the warnings on the product itself are persons who are familiar with the installation, assembly, commissioning and operation of the product and who have the qualifications appropriate to their job, such as

- *training and instruction or authorisation to switch circuits and devices/systems on and off, to earth and to label them in accordance with the standards of safety technology.*
 - *Training or instruction in accordance with safety technology standards in maintenance and use of appropriate safety equipment.*
 - *First Aid Training*
-

Delivery, Storage and Transport

10 Scope of Delivery

The standard delivery of the pressure/level probes comprises:

- Pressure/Level Probe (according to delivery documents)
- Technical description (with Declarations of Conformity and respective Ex Certificates) including all information required for operation of the pressure/level probe (printed copy or link to the NIVUS download centre)

Check additional accessories according to the order against the delivery note.

11 Inspection upon Receipt

Check the delivery for completeness and apparent intactness immediately after receipt. Report any transport damage immediately to the delivering carrier. Also send a written report to NIVUS GmbH in Eppingen.

Incomplete deliveries must be addressed in writing within two weeks to your responsible representative or directly to the head office in Eppingen.



Observe the two-week deadline

Complaints received later will not be recognised.

12 Storage

Observe the minimum and maximum values for external conditions such as temperature and humidity according to Chapter "18 Specifications".

Protect the pressure/level probes from corrosive or organic solvent vapours, radioactive radiation and strong electromagnetic radiation.

13 Transport

Protect the pressure/level probes from strong impacts, blows, shocks or vibrations by using appropriate safety measures such as straps or similar.

Otherwise, the same conditions apply with regard to external influences as for storage (see Chap. "12 Storage").

14 Return

In the event of a return, send the unit to NIVUS GmbH in Eppingen carriage paid and in the original packaging.

Items that have not been sufficiently franked will not be accepted!

In general, a return note (incl. RMA return number) must be requested from the NIVUS customer service before returning the goods. Without this RMA number, the incoming goods cannot be assigned accordingly.



See Chap. "24.2 Customer Service Information".

Product Description

15 Overview and Use



- 1 AquaBar II
- 2 AquaBar BS
- 3 UniBar E II (with display)
- 4 UniBar E II

Fig. 15-1 Overview pressure and level probes

16 Designs

a) Pressure Transmitters

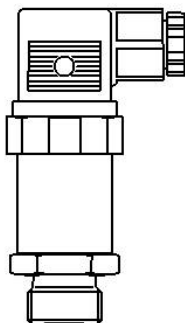

DIN 3852

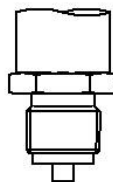

EN 837-1 / -3

Level transmitters

b) Screw-in

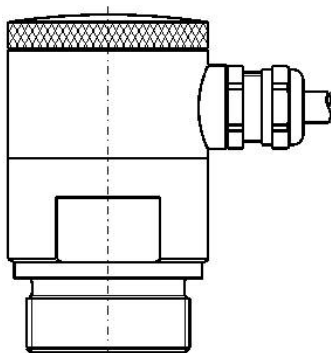

c) cable



Fig. 16-1 Pressure transmitter / screw-in probes / hanging probes

17 Device ID

The information in this manual only applies to the probe types indicated on the title page.

The nameplate is attached to the sensor body and contains the following information:

- Name and address NIVUS GmbH
- CE label
- Marking of the series and type with article number and serial number
- Ex Protection Label
- Ambient conditions in operation

It is important for all queries and spare parts orders that the article number and serial number of the respective probe are specified correctly. This is the only way to ensure proper and fast processing.



Note

Check by means of the nameplates whether the supplied probe corresponds with your order.

Check that the correct voltage supply is indicated on the nameplate.















 D-75031 Eppingen	AquaBar II	 0044	 II 1G Ex ia IIC T4 Ga II 1D Ex ia IIIC T135°C Da
	MB: 0...10 mWs	 	Ui: 28 VDC Ci: 0 nF Ii: 93 mA Li: 0 µH Pi: 660 mW
 Art.-Nr.: HSB0ABW010E020K		 Ser.-Nr.: 01234567	
 D-75031 Eppingen	UniBar E II	 0044	 II 1G Ex ia IIC T4 Ga II 1D Ex ia IIIC T135°C Da
	MB: 0...20 bar	 	Ui: 28 VDC Ci: 0 nF Ii: 93 mA Li: 0 µH Pi: 660 mW
 Art.-Nr.: HSB0UEB020EVU05		 Ser.-Nr.: 01234567	

Fig. 17-1 Nameplates of the pressure and level probes

18 Specifications

AquaBar II AquaBar BS (Non-Ex)	Submersible Probes
Supply Voltage (U_B)	12 ... 36 V DC intrinsically safe circuit 14...28 Volt / 93 mA ($P_i = 660$ mW)
Measurement Range	See Nameplate
Measurement signal (2-wire system)	4...20 mA
Load (max. 24 V)	600 Ohm / $R_{max} = (U_B - 12) / 0.02$ A
Connection Cable	Polyurethane cable shielded 2x 0.14 mm ² ; d = 9 mm
Enclosure	Material: V4A (AISI 316 Ti) Protection: IP68
Measurement Diaphragm	Stainless steel
Ex Approval	See the permissible Ex certificate/EU type examination certificate(s) for this in Chapter "Certificates and Approvals"
Ambient Temperature	<u>AquaBar II:</u> Zone 0 = -20...+60 °C at P_{atm} 0.8...1.1 bar As of Zone 1 = -20...+70 °C <u>AquaBar BS (Non-Ex):</u> -20...+70 °C
Storage Temperature	-25...+70 °C
Max. Humidity	80 %, non-condensing
	The probes must be stored protected from corrosive or organic solvent vapours, radioactive radiation and strong electromagnetic radiation.

Tab. 3 Specifications Aqua Bar II, Aqua Bar BS

UniBar E II	Pressure Probes
Supply Voltage (U_B)	12...36 V DC intrinsically safe circuit 14...28 Volt / 93 mA ($P_i = 660$ mW)
Measurement Range	See Nameplate
Measurement signal (2-wire system)	4...20 mA
Load (max. 24 V)	600 Ohm / $R_{max} = (U_B - 12) / 0.02$ A
Enclosure	Material: V4A (AISI 316 Ti); Protection: IP67 (field enclosure), IP65 enclosure with DIN ISO 4400 plug connector Cable gland: M20x1.5 or M12x1.5 (with DIN ISO 4400 plug connector)
Measurement Diaphragm	Stainless steel V4A (AISI 316 Ti)
Ex Approval	See the permissible Ex certificate/EU type examination certificate(s) for this in Chapter "Certificates and Approvals"
Ambient Temperature	<u>UniBar E II (Ex):</u> Zone 0 = -20...+60 °C at P_{atm} 0.8...1.1 bar As of Zone 1 = -20...+70 °C <u>UniBar E II (Non-Ex):</u> -40...+85 °C
Storage Temperature	-40...+100 °C
Max. Humidity	80 %, non-condensing
	The probes must be stored protected from corrosive or organic solvent vapours, radioactive radiation and strong electromagnetic radiation.

Tab. 4 Specifications UniBar E II

19 Device Versions

The pressure and level probes are manufactured in several versions. The tables below provide an overview on the different options.

HSB0	AquaBar II				
	Type				
	AB	Submersible probe with stainless steel membrane for level measurement			
	Measurement unit				
	W	Water Column			
	Measurement Ranges				
	002	2 meters wc			
	004	4 meters wc			
	006	6 meters wc			
	010	10 meters wc (20 m cable recommended)			
xxx	Special measurement range (max. 250 m wc)				
ATEX Approval					
0	none				
E	Zone 0				
Cable length					
010	10 m				
020	20 m				
030	30 m				
050	50 m				
099	100 m				
xxx	Special cable length upon request				
Design					
	K	Standard			
HSB0	AB	W		0	K

Tab. 5 Product structure AquaBar II

HSB0	AquaBar BS				
	Type				
	BS	Submersible probe with piezoresistive measurement cell			
	Measurement unit				
	W	Water Column			
	Measurement Ranges				
	004	4 meters wc			
	006	6 meters wc			
	010	10 meters wc (min. 20 m cable recommended)			
	020	20 meters wc (min. 30 m cable recommended)			
xxx	Special measurement range (max. 250 m wc)				
ATEX Approval					
0	none				
Cable length					
010	10 m				
020	20 m				
030	30 m				
050	50 m				
099	100 m				
xxx	Special cable length upon request				
Design					
K	Standard				
HSB0	BS	W		0	K

Tab. 6 Product structure AquaBar BS

HSB0	UniBar E II						
	Type						
	UE	Pressure transmitter with stainless steel membrane 1.4404 (AISI 316 L)					
		Measurement unit					
		B	Bar				
		W	Water Column				
		Measurement Ranges					
		001	1 bar / 1 m wc				
		002	2 bar / 2 m wc				
		004	4 bar / 4 m wc				
		006	6 bar / 6 m wc				
		010	10 bar / 10 m wc				
		020	20 bar / 20 m wc				
		xxx	Special measurement range (max. 40 bar)				
		ATEX Approval					
		0	none				
		E	Zone 0				
		Gasket					
		V	Viton				
		Enclosure/Connection					
		U	Stainless steel, not rotatable				
		K	Plug connector according to DIN ISO 4400				
		E	Display (LCD, integrated) (no ATEX approval)				
		Mechanic connection/ Process connection					
		05	G½" thread DIN 3852 open connection with 12 mm hole				
HSB0	UE	W			V		05

Tab. 7 Product structure UniBar E II

Function Description

20 Functional Principle

20.1 General

The 2-wire pressure probe is used to measure static and dynamic pressures of gaseous and liquid media. Relative pressure (negative and positive pressure) as well as absolute pressure can be measured. The pressure is converted into a standardised electrical signal.

Installation, Mounting and Connection

21 General Installation Instructions

Before commissioning the installation of pressure and level probes must be completed. Verify whether the installation is correct. Observe that the installation shall be carried out only by qualified expert personnel.

For electric installation the legal requirements of the according country must be followed (in Germany: e.g. VDE 0100).

CAUTION



Warning in personal injury or property damage

Ensure proper installation.

Follow applicable legal or company guidelines.

Improper handling may lead to personal injuries and/or equipment damage.

22 Installation

22.1 General

The place for mounting the pressure and level probe must be selected according to certain criteria.

Make sure to **avoid**:

- Direct sunlight
- Objects that radiate strong heat (max. ambient temperature: see Chap. "18 Specifications")
- Objects with a strong electromagnetic field (frequency converters or similar)
- Corrosive chemicals or gases
- Mechanical shocks
- Vibrations
- Radioactive radiation
- Direct installation at footpaths or travel ways

For pressure probes, the fastening is done using the external thread ($\frac{1}{2}$ " or $1\frac{1}{2}$ " attached to the housing, and for immersion probes, using a straining clamp (optional).



Note

Use suitable tools to install the units and do not use force. Tighten cable glands carefully.

For hanging probes, remove the protective cap (Fig. 25-1), as this serves only as transport protection.

The protection class of the housing is IP65/IP67 for pressure probes with screw-in thread (1/2" or 1 1/2") and IP68 for immersion probes.



Maintain tightness

In the case of immersion probes, the housing must not be opened, as this would no longer guarantee the degree of protection (tightness).

For pressure probes, the enclosure cover must always be screwed on correctly so that the specified degree of protection is maintained.

22.2 Dimensions

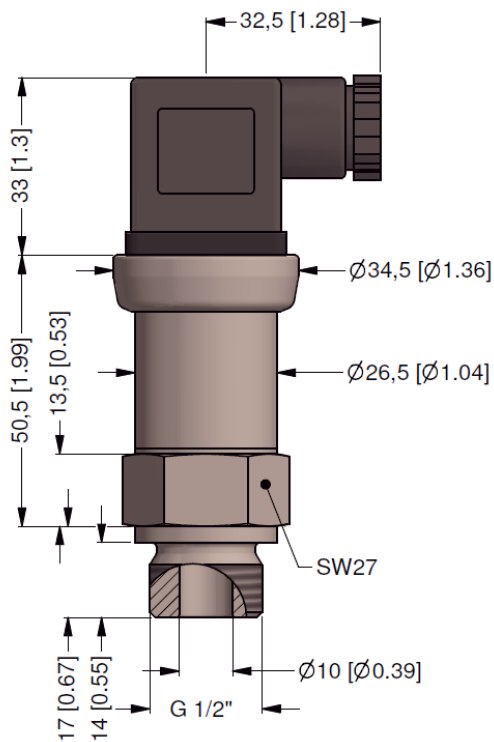

Fig. 22-1 Probe – UniBar E II with plug

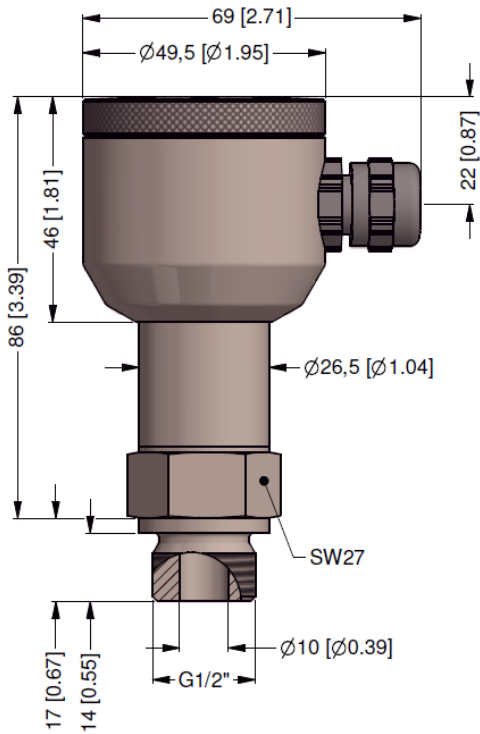

Fig. 22-2 UniBar E II with display (in stainless steel enclosure)

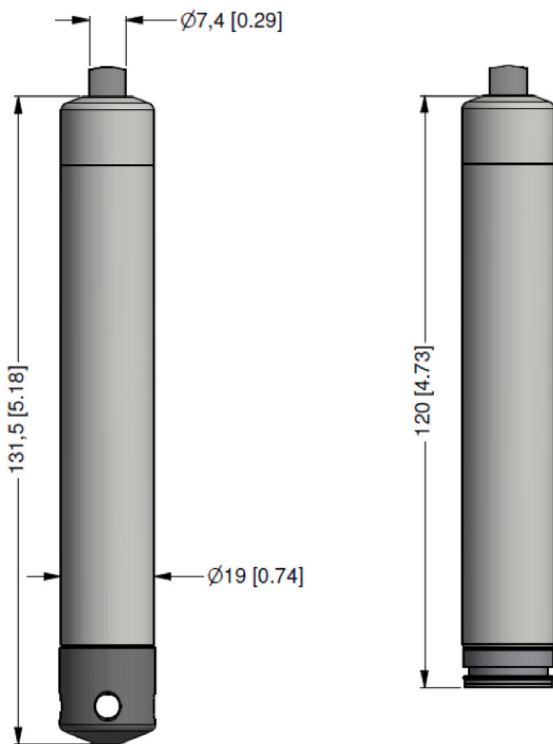

Fig. 22-3 Probe – AquaBar BS

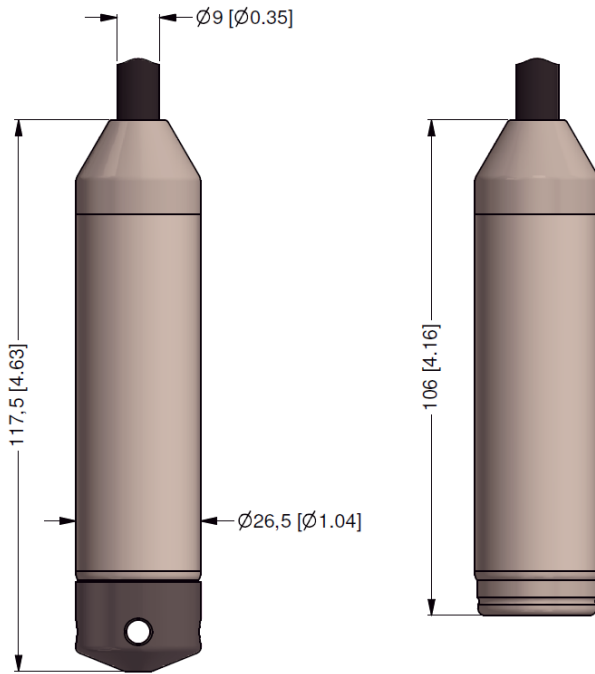

Fig. 22-4 **Probe – AquaBar II**

23 Connection



Grounding the Probe

When using the probe in the Ex zone, the sensor enclosure must be grounded! This is to be realised with immersion probes via the cable shield and with pressure probes via the ground terminal located in the enclosure.

When using the probe in conjunction with NIVUS Ex-GPRS data loggers of the types NivuLog Easy and NivuLog 2 Ex (N), connect the shield to the GND/ground terminal.

Observe the accompanying instruction manual!



Observe maximum values!

The electrical connection may only be made to a certified intrinsically safe circuit with the maximum values specified in the Ex certificate / EU type examination certificate.



Provide strain relief on the cable

If the installation is carried out hanging from the cable, the cable must be provided with strain relief by using a straining clamp.

With an immersion probe, the device connection is made via the sensor cable. A screw-in probe is connected via the integrated connection terminals.

Connection Requirements

- The cable must end in a dry room, e.g. in the control cabinet.
- If a junction box is used, pressure compensation must be provided.
- The probe cable can be shortened.



The filter on the pressure compensation hose must not be removed!

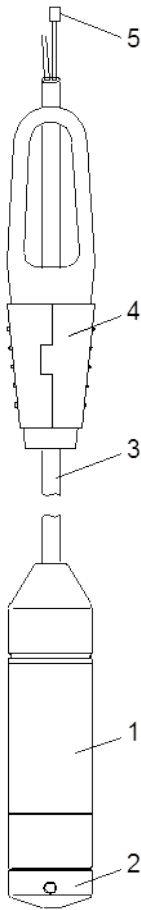

- 1 Probe body
- 2 Protective cap (transport protection, remove for operation)
- 3 Cable
- 4 Straining clamp
- 5 Pressure compensation hose and filter element

Fig. 23-1 Overview hanging probes

23.1 Connector Pin Assignment

Connector Pin Assignment	Electrical Connections			
	DIN ISO 4400	Binder 723 (5 poles)	Connection Terminals	Cable Colours
Power Supply +	1	3	(In+) +UB/US+	red (white)*
Power Supply -	2	4	(In-) -UB/US-	blue (brown)*
Ground / PE	Ground Contact	5	GND / PE	Cable shield (green/yellow)*
Output +	not connected	not connected	Out+/S+	

* The cable colour used depends on the cable sheath material used (PTFE/PUR).

Tab. 8 Connector Pin Assignment

23.2 Wiring

The probes are wired in 2-wire technology.

With a supply voltage of 24 volts DC, a current flow/measurement signal between 4...20 mA is generated.

If the measuring range is exceeded, the measuring current can rise above 20 mA.

The maximum value depends on the supply voltage and the load resistor used.

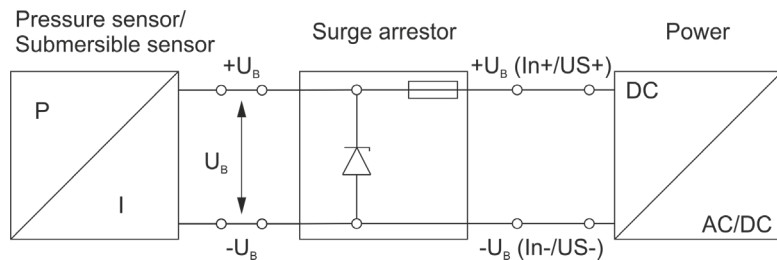

Fig. 23-2 Wiring example - connection for Ex probes

23.3 Supply Voltage

The supply voltage can be in the range between 12...36 volts DC (for Ex 14...28 Volt DC). However, it should be noted that the max. possible load resistance depends on the supply voltage.

18 Volt (Ex: 20 Volt) ... max. 300 Ohm

24 Volt (Ex: 26 Volt) ... max. 600 Ohm



Supply and Signal Circuit:

In ignition protection type intrinsic safety Ex ia IIC/IIB only for connection to a certified intrinsically safe circuit. When using intrinsically safe devices as Zone 0/20 equipment, the power supply must be provided by means of a ground-free and galvanically isolated supply isolator (e.g. NivuCont Plus).

The design was carried out using the standards EN IEC 60079-0:2018 and EN 60079-11:2012.

The safety-related values of the connected pressure/level probes must correspond to the specifications in the technical data or the Ex certificate/EU type examination certificate.

If several active devices are interconnected in an intrinsically safe circuit, other safety-related values may result. Here, intrinsic safety may be endangered!

Details for the **pressure/level probe** without connection cable/extension:

U_i	=	28 V
I_i	=	93 mA
P_i	=	660 mW
C_i	=	0 nF
L_i	=	0 μ H

The values given are the internal values, without indication of the line capacitances and line inductances.

For **immersion probes** (cable) these values are:

Line capacitance $C_i = 160$ pF/m

Line inductance $L_i = 1$ μ H/m

Commissioning

Notes to the User

Before connecting and putting the pressure or level probe into operation, it is essential to observe the following instructions for use!

This instruction manual contains all information required for the use of the probes. The instructions are intended for technically qualified personnel who have relevant knowledge in the field of measurement technology and waste water hydraulics. To ensure the proper functioning of the probes, this manual must be read carefully.

The supplied pressure/level probe must be wired according to the specified terminal assignment in chapter "23.1 Connector Pin Assignment".

In the event of any uncertainties or difficulties regarding installation and connection, please contact our technical department or our commissioning service.



Note

The measurement signal is in the range of approx. 3.6...22 mA (the upper value depends on the supply voltage).

Measurement range: see nameplate (Fig. 17-1)

Measurement signal: 4...20 mA

Maintenance and Cleaning

WARNING *Germ Contamination*



Due to the frequent use of the sensors in the waste water sector, parts can be contaminated with dangerous germs. Therefore, appropriate precautions must be taken when coming into contact with cables and sensors.

Wear protective clothing.

24 Maintenance

24.1 Maintenance Interval

The probes are virtually maintenance- and wear-free by design. Nevertheless, NIVUS recommend an **annual check** of the entire measuring system by the NIVUS customer service.

Depending on the area of application, the maintenance interval may vary.

The entire measurement system incl. connection cable must be checked for damage.

In addition to the annual maintenance, NIVUS recommend a complete maintenance of the measuring system by the NIVUS customer service after **ten years at the latest**.

Generally, the verification of sensors and probes is a basic measure in order to improve operational reliability and to increase the lifetime.

Contact the NIVUS customer service to make an appointment (see Chap. "24.2 Customer Service Information").

24.2 Customer Service Information

For maintenance measures to be carried out by NIVUS, the recommended annual inspection of the entire measuring system or complete maintenance after ten years at the latest, contact our customer service:

NIVUS GmbH - Customer Centre

Phone +49 7262 9191-922

customercenter@nivus.com

25 Cleaning

If necessary, clean the probe enclosure with a slightly damp lint-free cloth.



Static Charge

There is a risk of static charge when cleaning with a dry cloth.

For heavy soiling, the use of wetting agents (standard dishwashing detergents) is recommended.

Do **not** use abrasive or scratching cleaning agents.

To clean the diaphragm, remove the protective cap (as described below).

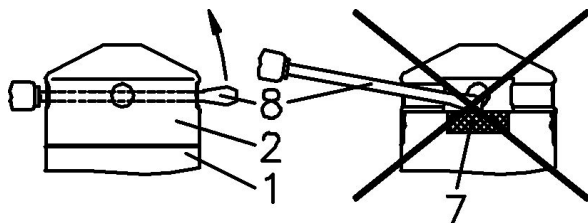

- 1 Probe part
- 2 Protective cap
- 7 Measurement cell
- 8 Tool for opening

Fig. 25-1 Removing the protective cap



Manually:

1. Hold tight the probe part (Fig. 25-1 Pos. 1).
2. Tilt the protective cap (Fig. 25-1 Pos. 2) and pull it off.



Using a screwdriver or similar:

1. Insert the tool (Fig. 25-1 Pos. 8) straight through the holes in the protective cap and make sure that you do not damage the measurement cell (Fig. 25-1 Pos. 7).

26 Dismantling/Disposal

Dispose of the device in accordance with the applicable local environmental regulations for electrical products.



EU WEEE Directive

This symbol indicates that the requirements of Directive 2012/19/EU on waste electrical and electronic equipment must be observed when disposing of the device. NIVUS GmbH support and promote the recycling or environmentally sound, separate collection/disposal of waste electrical and electronic equipment to protect the environments and human health. Observe the local laws and regulations on disposal.

NIVUS GmbH is registered with the EAR, therefore public collection and return points in Germany can be used for disposal.

27 Installation of Spare Parts and Wearing Parts

We expressly draw your attention to the fact that spare parts and accessories which have not been supplied by us have also not been tested and approved by us. The installation and/or use of such products may therefore negatively alter or invalidate the design properties of your measurement system.

NIVUS are not liable for damage caused by the use of non-original parts and non-original accessories.

Index

A	
Applicable Documentation	7
Approval	13
C	
Cleaning	39, 40
Commissioning	38
Connection	28
Copyrights	3
Customer Centre	39
D	
Designs	20
Device ID	21
Device Versions	24
Dimensions	30
Disclaimer	12
Dismantling	41
Disposal	41
F	
Functional Principle	27
G	
GermS	11, 39
I	
Inspection upon Receipt	17
Installation	28
Intended Use	13
M	
Maintenance	39
Maintenance Interval	39
N	
Names	3
O	
Operator's Duties	15
Overview	19
P	
Precautions	11
Property Rights	3
Q	
Qualified Personnel	16
R	
Return	18
S	
Safety Instructions	9
Safety Measures	11
Scope of Delivery	17
Spare Parts	41
Specifications	22
Storage	17
Symbols	9
T	
Translation	3
Transport	17
Type Key	24
W	
Warranty	11
Wearing Parts	41

Certificates and Approvals

DE / EN / FR



NIVUS GmbH
Im Taele 2
75031 Eppingen

Telefon: +49 07262 9191-0
Telefax: +49 07262 9191-999
E-Mail: info@nivus.com
Internet: www.nivus.de

EU Konformitätserklärung

EU Declaration of Conformity

Déclaration de conformité UE

Für das folgend bezeichnete Erzeugnis:

For the following product:

Le produit désigné ci-dessous:

Bezeichnung:	AquaBar II, AquaBar BS, HydroBar G II, NivuBar H III, NivuBar G II, NivuBar Plus II, UniBar E II
<i>Description:</i>	<i>AquaBar II, AquaBar BS, HydroBar G II, NivuBar H III, NivuBar G II, NivuBar Plus II, UniBar E II</i>
<i>Désignation:</i>	<i>AquaBar II, AquaBar BS, HydroBar G II, NivuBar H III, NivuBar G II, NivuBar Plus II, UniBar E II</i>
Typ / Type:	HSB0....

erklären wir in alleiniger Verantwortung, dass die auf dem Unionsmarkt ab dem Zeitpunkt der Unterzeichnung bereitgestellten Geräte die folgenden einschlägigen Harmonisierungsvorschriften der Union erfüllen:

we declare under our sole responsibility that the equipment made available on the Union market as of the date of signature of this document meets the standards of the following applicable Union harmonisation legislation:

nous déclarons, sous notre seule responsabilité, à la date de la présente signature, la conformité du produit pour le marché de l'Union, aux directives d'harmonisation de la législation au sein de l'Union:

- 2014/30/EU
- 2011/65/EU

Bei der Bewertung wurden folgende einschlägige harmonisierte Normen zugrunde gelegt bzw. wird die Konformität erklärt in Bezug auf die nachfolgend genannten anderen technischen Spezifikationen:

The evaluation assessed the following applicable harmonised standards or the conformity is declared in relation to other technical specifications listed below:

L'évaluation est effectuée à partir des normes harmonisées applicable ou la conformité est déclarée en relation aux autres spécifications techniques désignées ci-dessous:

- EN 61326-1:2013

Diese Erklärung wird verantwortlich für den Hersteller:

This declaration is submitted on behalf of the manufacturer:

Le fabricant assume la responsabilité de cette déclaration:

NIVUS GmbH
Im Taele 2
75031 Eppingen
Germany

abgegeben durch / *represented by / faite par:*

Ingrid Steppe (Geschäftsführerin / *Managing Director / Directeur général*)

Eppingen, den 25.10.2022

Gez. *Ingrid Steppe*



UK Declaration of Conformity

NIVUS GmbH
Im Taele 2
75031 Eppingen

Telefon: +49 07262 9191-0
Telefax: +49 07262 9191-999
E-Mail: info@nivus.com
Internet: www.nivus.de

For the following product:

Description: AquaBar II, AquaBar BS, HydroBar G II, NivuBar H III, NivuBar G II,
NivuBar Plus II, UniBar E II

Type: HSB0....

we declare under our sole responsibility that the equipment made available on the UK market as of the date of signature of this document meets the standards of the following applicable UK harmonisation legislation:

- SI 2016 / 1091 The Electromagnetic Compatibility Regulations 2016
- SI 2012 / 3032 The Restriction of the Use of Certain Hazardous Substances in Electrical and Electronic Equipment Regulations 2012

The evaluation assessed the following applicable harmonised standards or the conformity is declared in relation to other technical specifications listed below:

- BS EN 61326-1:2013

This declaration is submitted on behalf of the manufacturer:

NIVUS GmbH
Im Taele 2
75031 Eppingen
Germany

represented by:

Ingrid Steppe (Managing Director)

Eppingen, 25/10/2022

Signed by *Ingrid Steppe*



NIVUS GmbH
Im Tale 2
75031 Eppingen

Telefon: +49 07262 9191-0
Telefax: +49 07262 9191-999
E-Mail: info@nivus.com
Internet: www.nivus.de

EU Konformitätserklärung

EU Declaration of Conformity

Déclaration de conformité UE

Für das folgend bezeichnete Erzeugnis:

For the following product:

Le produit désigné ci-dessous:

Bezeichnung:	"Ex" UniBar E II, "Ex" AquaBar II
<i>Description:</i>	<i>"Ex" UniBar E II, "Ex" AquaBar II</i>
<i>Désignation:</i>	<i>"Ex" UniBar E II, "Ex" AquaBar II</i>
Typ / Type:	HSB0UExxxE..., HSB0ABWxxx...

erklären wir in alleiniger Verantwortung, dass die auf dem Unionsmarkt ab dem Zeitpunkt der Unterzeichnung bereitgestellten Geräte die folgenden einschlägigen Harmonisierungsvorschriften der Union erfüllen:

we declare under our sole responsibility that the equipment made available on the Union market as of the date of signature of this document meets the standards of the following applicable Union harmonisation legislation:

nous déclarons, sous notre seule responsabilité, à la date de la présente signature, la conformité du produit pour le marché de l'Union, aux directives d'harmonisation de la législation au sein de l'Union:

- 2014/34/EU
- 2014/30/EU
- 2011/65/EU

Bei der Bewertung wurden folgende einschlägige harmonisierte Normen zugrunde gelegt bzw. wird die Konformität erklärt in Bezug die nachfolgend genannten anderen technischen Spezifikationen:

The evaluation assessed the following applicable harmonised standards or the conformity is declared in relation to other technical specifications listed below:

L'évaluation est effectuée à partir des normes harmonisées applicable ou la conformité est déclarée en relation aux autres spécifications techniques désignées ci-dessous:

- EN 61326-1:2013
- EN 60079-11:2012
- EN IEC 60079-0:2018

Ex-Kennzeichnung / *Ex-designation / Marquage Ex :*

⊕ II 1G Ex ia IIC T4 Ga

⊕ II 1D Ex ia IIIC T135°C Da

EU-Baumusterprüfbescheinigung / *EU-Type Examination Certificate / Attestation d'examen «UE» de type:*

IBExU11ATEX1046X

Notifizierte Stelle (Kennnummer) / *Notified Body (Identif. No.) / Organisme notifié (N° d'identification)*

IBExU Institut für Sicherheitstechnik GmbH, 09599 Freiberg, **Allemagne** (0637)

Qualitätssicherung ATEX / *Quality assurance ATEX / Assurance qualité ATEX:*

TÜV Nord CERT GmbH, Am TÜV 1, 45307 Essen, **Germany** (0044)

Diese Erklärung wird verantwortlich für den Hersteller:

This declaration is submitted on behalf of the manufacturer:

Le fabricant assume la responsabilité de cette déclaration:

NIVUS GmbH
Im Taele 2
75031 Eppingen
Allemagne

abgegeben durch / *represented by / faite par:*

Marcus Fischer (Geschäftsführer / *Managing Director / Directeur général*)

Eppingen, den 26.08.2022

Gez. *Marcus Fischer*

Q:\Formulare\CE\CE_Template_IBEXU_TUEV_01



UK Declaration of Conformity

NIVUS GmbH
Im Taele 2
75031 Eppingen

Telefon: +49 07262 9191-0
Telefax: +49 07262 9191-999
E-Mail: info@nivus.com
Internet: www.nivus.de

For the following product:

Description: "Ex" UniBar E II, "Ex" AquaBar II

Type: HSB0UExxxE..., HSB0ABWxxx...

we declare under our sole responsibility that the equipment made available on the UK market as of the date of signature of this document meets the standards of the following applicable UK harmonisation legislation:

- SI 2016 / 1107 The Equipment and Protective Systems Intended for use in Potentially Explosive Atmospheres Regulations 2016
- SI 2016 / 1091 The Electromagnetic Compatibility Regulations 2016
- SI 2012 / 3032 The Restriction of the Use of Certain Hazardous Substances in Electrical and Electronic Equipment Regulations 2012

The evaluation assessed the following applicable harmonised standards or the conformity is declared in relation to other technical specifications listed below:

- BS EN 61326-1:2013
- BS EN 60079-11:2012
- BS EN IEC 60079-0:2018

Ex-designation:

⊕ II 1G Ex ia IIC T4 Ga
⊕ II 1D Ex ia IIC T135°C Da

EU-Type Examination Certificate:

IBExU11ATEX1046X

Notified Body (Identif. No.):

IBExU Institut für Sicherheitstechnik GmbH, 09599 Freiberg, Germany (0637)

Quality Assurance Ex:

TÜV Nord CERT GmbH, Am TÜV 1, 45307 Essen, Germany (0044)

This declaration is submitted on behalf of the manufacturer:

NIVUS GmbH
Im Taele 2
75031 Eppingen
Germany

represented by:

Ingrid Steppe (Managing Director)

Eppingen, 20/10/2022

Signed by *Ingrid Steppe*

IBeXU Institut für Sicherheitstechnik GmbH
An-Institut der TU Bergakademie Freiberg

[1] **EU-TYPE EXAMINATION CERTIFICATE - Translation**



- [2] Equipment or protective systems intended for use in potentially explosive atmospheres, Directive 2014/34/EU
- [3] EU-type examination certificate number **IBeXU11ATEX1046 X** | Issue 2
- [4] Product: **Pressure measuring device**
Type: AquaBar II and UniBar E II
- [5] Manufacturer: NIVUS GmbH
- [6] Address: Im Täle 2
75031 Eppingen
GERMANY
- [7] This product and any acceptable variation thereto is specified in the schedule to this certificate and the documents therein referred to.
- [8] IBeXU Institut für Sicherheitstechnik GmbH, Notified Body number 0637 in accordance with Article 17 of Directive 2014/34/EU of the European Parliament and of the Council, dated 26 February 2014, certifies that this product has been found to comply with the essential health and safety requirements relating to the design and construction of products intended for use in potentially explosive atmospheres given in Annex II to the Directive.
- The examination and test results are recorded in the confidential test report IB-21-3-0094.
- [9] Compliance with the essential health and safety requirements has been assured by compliance with: EN IEC 60079-0:2018 and EN 60079-11:2012
Except in respect of those requirements listed at item [18] of the schedule.
- [10] If the sign "X" is placed after the certificate number, it indicates that the product is subject to the specific conditions of use specified in the schedule to this certificate.
- [11] This EU-type examination certificate relates only to the design and construction of the specified product. Further requirements of the Directive apply to the manufacturing process and supply of this product. These are not covered by this certificate.
- [12] The marking of the product shall include the following:

II 1G Ex ia IIC or IIB T4 Da
 II 1D Ex ia IIIC T135 °C Da

IBeXU Institut für Sicherheitstechnik GmbH
Fuchsmühlenweg 7
09599 Freiberg, GERMANY

By order

Dipl.-Ing. (FH) A. Henker



- Seal -
(Notified Body number 0637)

Tel: + 49 (0) 37 31 / 38 05 0
Fax: + 49 (0) 37 31 / 38 05 10

Certificates without signature and seal are not valid. Certificates may only be duplicated completely and unchanged. In case of dispute, the German text shall prevail.

Freiberg, 2021-12-21

IBExU Institut für Sicherheitstechnik GmbH
An-Institut der TU Bergakademie Freiberg

[13] **Schedule**

[14] **Certificate number IBExU11ATEX1046 X | Issue 2**

[15] **Description of product**

The pressure measuring devices AquaBar II und UniBar E II are different pressure measurement devices or level probe in stainless steel enclosure with different pressure ports. As measuring cell and evaluation electronic serves a separately approved electronic module. The devices are intended for use in potentially hazardous areas, where Category 1G devices are required. They are supplied by an intrinsically safe power supply of the Category „ia“.

Types:

Equipment	Connection	Design	Enclosure
AquaBar II	cable	immersion probe	stainless steel
UniBar E II	plug	screw-in probe	stainless steel

Technical data

Ambient temperature range: from -20 °C to +70 °C

Electrical data

Supply and signal electric circuit in type of protection Intrinsic Safety Ex ia IIC (supply + and -)

	U _i	28 V DC
	I _i	93 mA
effective inner capacity	P _i	660 mW
effective inner inductivity	C _i	negligible
	L _i	negligible

plus line inductivities 1 µH/m and line capacities 160 pF/m (cable supplied by the manufacturer)
The supply connections have an inner capacity of max. 27 nF opposite the enclosure.

Variations compared to issue 1 of this certificate:

The device also complies with the current standard EN IEC 60079-0: 2018.

[16] **Test report**

The test results are recorded in the confidential test report IB-21-3-0094 of 2021-12-07.

The test documents are part of the test report and they are listed there.

Summary of the test results

The pressure measuring devices AquaBar II and UniBar E II fulfil the requirements of type of protection Intrinsic Safety „ia“ for an electrical equipment of the Equipment Group II, Category 1G and 1D, Explosion Group IIC or IIB and Temperature Class T4.

[17] **Specific conditions of use**

- The equipment designed with connector have to be installed in such a way that the degree of protection IP 20 is always kept.
- The ambient temperature range is fixed from -20 °C to +70 °C.
- The safety and assembly notes contained in the operating instructions have to be observed.
- Dust deposits > 5mm and any dust covering, must be avoided.
- The device may be used in an explosive atmosphere, the apparatus of category 1 requires only operate if there are atmospheric conditions (temperature of -20 °C to +60 °C, pressure of 0.8 bar to 1.1 bar).

IBExU Institut für Sicherheitstechnik GmbH
An-Institut der TU Bergakademie Freiberg

[18] Essential health and safety requirements

In addition to the essential health and safety requirements (EHSRs) covered by the standards listed at item [9], the following are considered relevant to this product, and conformity is demonstrated in the test report:

none

[19] Drawings and Documents

The documents are listed in the test report.

IBExU Institut für Sicherheitstechnik GmbH
Fuchsmühlenweg 7
09599 Freiberg, GERMANY

By order



Dipl.-Ing. (FH) A. Henker

Freiberg, 2021-12-21