

## Instruction Manual

### Flow Transmitter

### NivuFlow Mobile 600 / NivuFlow Mobile 600 Ex



Firmware Version: 5.2.x

### Revised Instruction Manual

Document Revision 05 / 09.06.2023

Original Instruction Manual: German / Rev. 05 as of 30.01.2023

measure analyse optimise

**NIVUS AG, Switzerland**

Burgstrasse 28  
8750 Glarus, Switzerland  
Phone +41 55 6452066  
Fax +41 55 6452014  
swiss@nivus.com  
www.nivus.com

**NIVUS Austria**

Mühlbergstraße 33B  
3382 Loosdorf, Austria  
Phone +43 2754 5676321  
Fax +43 2754 5676320  
austria@nivus.com  
www.nivus.com

**NIVUS Sp. z o.o., Poland**

ul. Hutnicza 3 / B-18  
81-212 Gdynia, Poland  
Phone +48 58 7602015  
Fax +48 58 7602014  
biuro@nivus.pl  
www.nivus.pl

**NIVUS France**

12 rue Principale  
67870 Bischoffsheim, France  
Phone +33 388 999284  
info@nivus.fr  
www.nivus.fr

**NIVUS Ltd., United Kingdom**

Furzen Hill Farm  
Coventry Road, Cubbington  
Royal Leamington Spa  
CV32 7UJ, Warwickshire  
Phone +44 8445 332883  
nivusUK@nivus.com  
www.nivus.com

**NIVUS Middle East (FZE)**

Prime Tower  
Business Bay Dubai  
31<sup>st</sup> floor, office C-3  
P.O. Box: 112037  
Phone +971 4 4580502  
middle-east@nivus.com  
www.nivus.com

**NIVUS Korea Co. Ltd.**

#2301 M-Dong Technopark IT Center,  
32 Songdogwahak-ro, Yeonsu-gu,  
INCHEON, Korea 21984  
Phone +82 32 2098588  
Fax +82 32 2098590  
jhwon@nivuskorea.com  
www.nivuskorea.com

**NIVUS Vietnam**

238/78 Phan Trung Street  
Tan Tien Ward, Bin Hoa City  
Dong Nai Province, Vietnam  
Phone +84 94 2623979  
jhwon@nivuskorea.com  
www.nivus.com

## Copyrights and Property Rights

The contents of this document including tables and drawings are proprietary to NIVUS GmbH and are not to be reproduced or copied without express written permission.

Violations oblige to compensation.



---

### **Important**

*This instruction manual - even in parts - may exclusively be copied or translated in any other way with the express written consent of NIVUS GmbH.*

---

### **Translation**

If the device is sold to a country in the European Economic Area (EEA) this instruction manual must be translated into the language of the country in which the device is to be used.

Should the translated text be unclear, the original instruction manual (German) must be consulted or a member company of the NIVUS-Group must be contacted for clarification.

### **Copyright**

No part of this publication may be reproduced, transmitted, sold or disclosed without prior permission. Violations oblige to compensation. All rights reserved.

### **Names**

The use of general descriptive names, trade names, trademarks and the like in this manual does not entitle the reader to assume they may be used freely by everyone. They are often protected registered trademarks even if not marked as such.

## Revision History

Rev.	Modifications	Responsible Editor	Date
05	Firmware version updated; addresses of branch offices updates; Chap. "2.3 Interfaces", "4 Special safety and Precautionary Measures", "6 Disclaimer", "8 Ex Protection", "11 Scope of Delivery", "15 Return", "16.2 Connectable Sensors/Devices", "18 Specifications" and "19.1 Device Versions" updated; Chap. "19.2 Add-On Function Licences" added; Chap. "23.2 Rechargeable Battery Block" updated; Chap. "25 10-pole/18-pole Plugs" added; Chap. "28 Connecting the Connector Box for Inputs/Outputs", "29 Antenna for 2G/3G/4G Remote Data Transmission", "31 Lighting System of the Status LED on NivuFlow Mobile" and "33.1 Overview Display" updated; Chap. "Main Screen" added; Chap. "40 Procedure for Setting Parameters via Quick Start", "41.2.6 Menu - Battery (12V)", "41.2.7 Menu – Quick Start" and "41.2.8 Menu – Alarm" updated; Chap. "42.1.10 3D Preview" and „42.1.12 System Times“ added; contents from former Chap. "Damping" and "Stability" integrated into Chap. "42.1.12 System Times"; Chap. "42.2 Menu v-Paths": general text adapted; former Chap. "41.2.1 Sensor Types in Transit Time Mode >Clamp-On<" and "41.2.2 Sensor Types in Transit Time Mode >Wetted<" removed, causing the following Chapter numbers to change; Chap. "42.2.1 Mounting Position of Sensors" updated; Chap. "42.2.2 Weighting" added; Chap. "42.2.3 v-Minimum and v-Maximum", "42.3 Menu Inputs and Outputs (analogue and digital)", "43.3 Menu Data Memory", "44.2.4 Data Units", "44.3 Menu Time/Date", "44.4 Menu Error Messages", "44.5 Menu Service", "44.6 Menu Storage Mode", "45 Parameter Menu Communication", "48 Parameter Menu Quick Start", "49 Parameter Menu Alarm", "53 Menu Diagnostics Signal Analysis" updated; Chap. "Troubleshooting" added; Chap. "Maintenance and Cleaning" and "Approvals and Certificates" updated; various minor text corrections; several (display) images adapted	MoG	09.06.2023
04	Chap. "23.1 Rechargeable Battery Block" changed; Chap. "52.2 Power Adapter/Charger" added; minor changes in text and layout	MoG	27.05.2020
03	Chap. "5 Warranty" added; Chap. "18 Technical Data" changed; Chap. "27 Connecting the Connector Box for Inputs/Outputs": procedure changed; Chap. "28 (T-Shape) Antenna for GPRS Remote Data Transmission": important note added; Chap. "36 Parameterisation via Quick Start": Fig. 37-4 updated; Chap. "37.2.7 Menu - Quick Start": Fig. 37 8 added; Chap. "40.5.5 Feature Unlock" changed; Chap. "44.3 Menu >Quick Start< / >v-Path 1<": Fig. 44-3 updated; Chap. "47 Menu Diagnostics v-Paths": Fig. and text for "Alignment" updated; Chap. "53 Dismantling/Disposal": note on „EU WEEE Directive" changed; Chap. "Approvals and Certificates" updated	MoG	17.03.2020
02	Address NIVUS France updated; Chap. "1.3.1 Colour Code for Wires and Single Wires", "5 Disclaimer", "22.1.3 Operation/Charging via alternative Power Source", Chap. " Overvoltage Protection Measures" added; Chap. "26 Connecting the Connector Box for Inputs/Outputs": Fig. 26-2 changed; Chap. "29 Lighting System of the Status LED on the	MoG	10.07.2019



## Revision History

	NivuFlow Mobile" added; Chap. "30 Connection Setup": "Session Timeout" removed; Chap. "31.3 Menus": "Alarm" added; Chap. "32.2 Parameterising a diametral 1-Path Measurement", "35 Parameterisation via Quick Start", "36.2.3 Menu - System", "36.2.7 Menu - Quick Start" changed; Chap. "36.2.8 Menu - Alarm" added; Chap. "37.3.1 Analogue Inputs", "37.3.3 Digital Inputs" "39.2.3 Units" and "39.2.4 Units Memory" changed. Chap. "39.5 Menu Service": "Feature Unlock" added. Chap. "39.6 Menu Storage Mode", "40 Parameter Menu Communication" and "43 Parameter Menu Quick Start" changed; Chap. "44 Parameter Menu Alarm" added; Chap. "48 Menu Diagnostics Signal Analysis" and "54 Accessories" changed; Chap. "Approvals and Certificates" updated; various menu figures updated		
01	Title page updated; new firmware version; Ex functionality added (concerns several chapters); Ex Certificate/CE Declarations of Conformity added/replaced and according references/figures changed; data transmission via GPRS/UMTS/LTE added; chapter structure changed: "Delivery, Storage and Transport"; chapter changed (contents or warnings): 2.1.2, 2.3, 3.2, 4, 15, 16, 17, 18, 20, 21, 22, 24, 26, 31, 34.5, 36.2.1, 36.2.4, 37.2.1, 37.2.2, 37.3.3, 37.3.4, 38.3, 39.3, 39.5, 39.6, 40 and 54; Chap. "Maintenance and Cleaning" changed; New chapters: "1.3 Abbreviations Used", "7 Ex Protection", "27 (T-Shape) Antenna for GPRS Remote Data Transmission" and "Credits and Licenses"; Various minor text corrections, several figures adapted.	MoG	09.11.2018
00	New Creation	MoG	04.09.2017

## Table of Contents

<b><u>Copyrights and Property Rights</u></b>	<b>3</b>
<b><u>Revision History</u></b>	<b>4</b>
<b><u>Table of Contents</u></b>	<b>6</b>
<b><u>General</u></b>	<b>11</b>
1 About this Manual.....	11
1.1 Applicable Documentation .....	11
1.2 Signs and Definitions used .....	11
1.3 Abbreviations used.....	12
1.3.1 Colour code for wires and single conductors.....	12
2 Connections and Control Elements.....	12
2.1 Power Supply .....	12
2.1.1 Transmitter .....	12
2.1.2 Rechargeable battery blocks .....	13
2.2 NivuFlow Mobile Control Elements .....	13
2.3 Interfaces .....	14
<b><u>Safety Instructions</u></b>	<b>15</b>
3 Used Symbols and Signal Words.....	15
3.1 Information on the Valuation of Accident Levels.....	15
3.2 Warning Notices on the Device (optional).....	16
4 Special safety and Precautionary Measures.....	17
5 Warranty.....	18
6 Disclaimer.....	18
7 Intended Use .....	19
8 Ex Protection .....	19
9 Duties of the Operator .....	20
10 Requirements for the Personnel .....	21
<b><u>Delivery, Storage and Transport</u></b>	<b>22</b>
11 Scope of Delivery .....	22
12 Inspection upon Receipt.....	22
13 Storage.....	22
14 Transport.....	23
15 Return.....	23
<b><u>Product Specification</u></b>	<b>24</b>
16 Product Construction and Overview.....	24
16.1 Enclosure dimensions .....	25
16.2 Connectable Sensors/Devices .....	25
17 Device ID.....	25
18 Specifications .....	27
19 Equipment .....	28
19.1 Device Versions .....	28

19.2 Add-On Function Licences.....	29
<b>Functional Description</b> .....	<b>30</b>
20 Areas of Use.....	30
21 Functional Principle.....	30
21.1 Flow Velocity Determination.....	30
21.2 Flow Rate Calculation.....	32
<b>Installation and Connection</b> .....	<b>33</b>
22 General.....	33
22.1 Mounting Place.....	33
22.2 Before Installation.....	33
22.2.1 PU Adhesive Plates on the Enclosure Frame.....	33
22.2.2 Gaskets.....	33
22.2.3 Securing the Instrument.....	34
22.2.4 Connection Sockets.....	34
23 Electrical Installation/Power Supply.....	34
23.1 General Information on the Power Supply.....	34
23.2 Rechargeable Battery Block.....	35
23.2.1 Removing/installing the battery block.....	35
23.2.2 Charging the battery block.....	36
23.2.3 Operation/charging via an alternative voltage source.....	38
23.2.4 Operation/Charging with direct connection to mains power.....	39
24 Installation of Sensors.....	40
24.1 Sensor Installation Principles.....	40
24.2 Installation of Clamp-On Sensors.....	40
24.3 Installation of wetted Sensors.....	42
25 10-pole/18-pole Plugs.....	44
25.1 Use at NIVUS.....	44
25.2 Special Features and Handling.....	44
26 Connection of Sensors.....	45
26.1 Cable for Sensor Connection.....	45
26.2 Connecting Sensors.....	45
26.3 Overvoltage Protection Measures.....	46
27 Single external Connection for Inputs/Outputs.....	46
28 Connecting the Connector Box for Inputs/Outputs.....	47
29 Antenna for 2G/3G/4G Remote Data Transmission.....	49
<b>Commissioning</b> .....	<b>51</b>
30 Notes to the User.....	51
31 Lighting System of the Status LED on NivuFlow Mobile.....	51
32 Connection Setup.....	53
32.1 Common.....	53
32.2 Android Operating System.....	53
32.3 iOS Operating System.....	56
32.4 Windows Operating System.....	59
33 Menu Control/Overview.....	62
33.1 Overview Display.....	62
33.2 Save Parameters.....	63

33.3	Menus.....	64
<b>Commissioning Examples</b>		<b>65</b>
34	Measuring with Clamp-On Sensors .....	65
34.1	General.....	65
34.2	Parameterisation of a diametral 1-path Measurement.....	65
34.2.1	Simple Parameterisation Procedure .....	65
34.2.2	Extended Parameterisation Procedure.....	68
35	Measuring with wetted Sensors .....	69
<b>Main Screen</b>		<b>70</b>
36	Functions of the Main Screen .....	70
37	General Overview.....	70
38	Display Fields .....	72
38.1	Display Field Flow .....	72
38.2	Level Display Field .....	72
38.3	Display Field Velocity .....	73
38.4	Temperature Display Field.....	74
38.5	Display Field Total.....	75
<b>Setting Parameters</b>		<b>76</b>
39	General Programming.....	76
39.1	Save Parameters .....	76
39.2	Change WLAN Password .....	76
39.3	Change the device SSID.....	77
39.4	Loss of the Password.....	77
39.5	Automatic Data Transmission to USB Stick.....	78
40	Procedure for Setting Parameters via Quick Start .....	78
41	Parameter Functions.....	82
41.1	Main Menu .....	82
41.2	Functions of the first Menu Level .....	82
41.2.1	Menu - Application .....	82
41.2.2	Menu – Data.....	83
41.2.3	Menu – System .....	84
41.2.4	Menu - Communication.....	85
41.2.5	Menu - Display .....	85
41.2.6	Menu - Battery (12V).....	86
41.2.7	Menu – Quick Start .....	86
41.2.8	Menu – Alarm.....	87
42	Parameter Menu Application.....	88
42.1	Menu Measurement Place .....	88
42.1.1	Measurement Place Name .....	89
42.1.2	Transit Time Mode .....	89
42.1.3	Number of Paths .....	90
42.1.4	Medium .....	90
42.1.5	(Medium) Temperature .....	91
42.1.6	Channel Profiles.....	91
42.1.7	Wall material .....	92
42.1.8	Lining.....	92
42.1.9	Sludge Level .....	92

42.1.10	3D Preview.....	92
42.1.11	Low-flow suppression .....	92
42.1.12	System Times .....	93
42.2	Menu v-Paths .....	93
42.2.1	Mounting Position of Sensors .....	94
42.2.2	Weighting .....	95
42.2.3	v-Minimum and v-Maximum.....	95
42.3	Menu Inputs and Outputs (analogue and digital) .....	96
42.3.1	Analogue Inputs .....	96
42.3.2	Analogue Outputs .....	98
42.3.3	Digital Inputs .....	99
42.3.4	Digital Outputs .....	100
42.4	Menu Diagnostics.....	102
43	Parameter Menu Data .....	102
43.1	Menu Trend.....	103
43.2	Menu Day Totals .....	104
43.3	Menu Data Memory.....	106
44	Parameter Menu System .....	110
44.1	Menu Information .....	110
44.2	Menu Country Settings.....	110
44.2.1	(Operating) Language.....	111
44.2.2	Date Format .....	111
44.2.3	Units .....	111
44.2.4	Data Units .....	112
44.3	Menu Time/Date.....	113
44.4	Menu Error Messages.....	114
44.5	Menu Service .....	115
44.5.1	Service Level.....	115
44.5.2	Restart.....	115
44.5.3	Powerdown .....	115
44.5.4	Parameter Reset.....	116
44.5.5	Feature Unlock.....	116
44.5.6	Update NivuFlow Mobile 600.....	119
44.5.7	Update Bootloader .....	119
44.6	Menu Storage Mode.....	119
45	Parameter Menu Communication .....	121
46	Parameter Menu Display.....	127
47	Parameter Menu Battery (12V) .....	128
48	Parameter Menu Quick Start.....	129
48.1	Menu >Quick Start< / >Country Settings< .....	129
48.2	Menu >Quick Start< / >Measurement Place<.....	130
48.3	Menu >Quick Start< / >v-Path x<.....	131
48.4	Menu >Quick Start< / >Analogue Input x<.....	131
48.5	Menu >Quick Start< / >Digital Input 1<.....	132
48.6	Menu >Quick Start< / >Communication<.....	132
49	Parameter Menu Alarm .....	133
49.1	Menu >Alarm< / >Flow<.....	133
49.2	Menu >Alarm< / >Velocity<.....	134
49.3	Menu >Alarm< / >Sound Velocity Medium< .....	135
49.4	Menu >Alarm< / >Water Temperature< .....	135

---

49.5	Menu >Alarm< / >Battery (12V)< .....	136
49.6	Menu >Alarm< / >Analogue Input x< .....	137
49.7	Menu >Alarm< / >Digital Input< .....	138
<b><u>Diagnostics</u></b>		<b>139</b>
50	Basics of the Diagnostics Menu .....	139
51	Menu Diagnostics v-Paths .....	140
52	Menu Diagnostics Inputs/Outputs .....	141
52.1	Important Information on Simulation .....	141
53	Menu Diagnostics Signal Analysis .....	143
54	Simulation.....	147
<b><u>Troubleshooting</u></b>		<b>148</b>
55	Possible Problems, Causes and Remedies .....	148
<b><u>Maintenance and Cleaning</u></b>		<b>157</b>
56	Maintenance.....	157
56.1	Maintenance Interval.....	157
56.2	Customer Service Information .....	158
57	Cleaning .....	158
57.1	Transmitter .....	158
57.2	Rechargeable Battery Blocks.....	158
57.3	Power Adapter/Charger .....	158
57.4	Transducers .....	158
58	Dismantling/Disposal.....	159
59	Installation of Spare Parts and Wearing Parts .....	159
60	Accessories .....	159
<b><u>Index</u></b>		<b>162</b>
<b><u>Credits and Licenses</u></b>		<b>165</b>
61	List of Sources of the Licences and Codes used .....	165
<b><u>Approvals and Certificates</u></b>		<b>166</b>

# General

## 1 About this Manual



**Important**

*READ CAREFULLY BEFORE USE.*

*KEEP IN A SAFE PLACE FOR LATER REFERENCE.*

This instruction manual is for the NivuFlow Mobile 600 flow measurement device and serves its intended use. This instruction manual is oriented exclusively to qualified expert personnel.

Read this instruction manual carefully and completely prior to installation or connection since it contains relevant information on this product. Observe the notes and particularly follow the warning notes and safety instructions.

If you should have problems to understand information contained within this instruction manual either contact a member company of the NIVUS-Group or one of the distributors for further support. The member companies of the NIVUS-Group cannot be held responsible for damage to persons or material due to incorrectly understood information in this instruction.

### 1.1 Applicable Documentation

For the installation and operation of the complete system extra instruction manuals or technical descriptions may be required apart from this manual.

- Technical Description for Transit Time Sensors
- Mounting Instruction for Transit Time Sensors

These manuals are provided with the auxiliary units or sensors and/or are available as download on the NIVUS homepage.

### 1.2 Signs and Definitions used

Representation	Meaning	Remarks
	(Action) Step	Execute action steps. Should action steps be numbered observe the specified order of the steps.
	Cross-reference	Refers to further or more detailed information
	Refers to a documentation	Refers to an accompanying documentation
>Text<	Parameter or menu	Indicates a parameter or a menu that is to be selected or is described

Tab. 1 Structural elements within the manual

## 1.3 Abbreviations used

### 1.3.1 Colour code for wires and single conductors

The abbreviations of colours for wire and single conductor labelling follow the international colour code according IEC 60757.

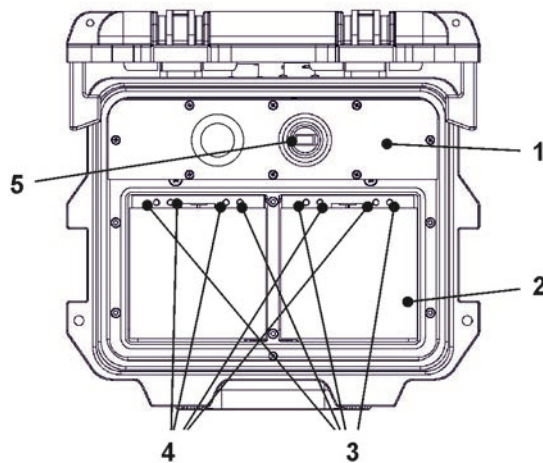
BK	Black	BN	Brown	RD	Red
OG	Orange	YE	Yellow	GN	Green
BU	Blue	VT	Violet	GY	Grey
WH	White	PK	Pink	TQ	Turquoise
GNYE	Green/Yellow	GD	Gold	SR	Silver

## 2 Connections and Control Elements

### 2.1 Power Supply

#### 2.1.1 Transmitter

The NivuFlow Mobile (Fig. 2-1 Pos. 1) is powered via the rechargeable battery blocks. When plugged into the enclosure, these are connected to the transmitter via the charging pins (Fig. 2-1 Pos. 4) and provide the required operating voltage.



- 1 Transmitter
- 2 Battery compartment (for two rechargeable battery blocks; no image)
- 3 Guide pins for battery blocks
- 4 Charging pins for AC power supply of the transmitter
- 5 USB-A Interface

**Fig. 2-1 Power supply by rechargeable /battery blocks (top view)**



### 2.1.2 Rechargeable battery blocks

The battery blocks are charged either when installed or when removed with the aid of the charger (available as an accessory).

**WARNING**

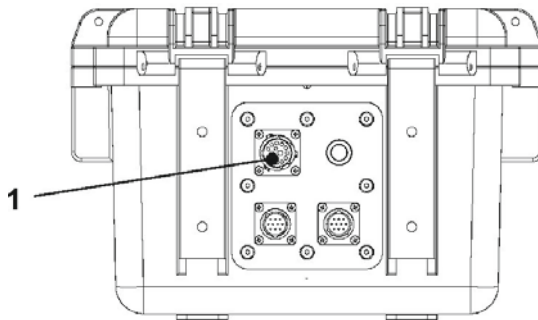


**Risk of explosion when charging the battery pack in Ex areas**

The battery pack may only be charged outside the Ex area. **Never within Ex areas.**

There are two different variants for charging the battery blocks when they are installed:

- Mains adapter 110...230 V AC via the multifunction socket (Fig. 2-2 Pos. 1) on the rear of the enclosure
- External power source 12...14 V DC (e.g. battery, solar module, fuel cell etc.) with connection cable via the multifunction socket



1 Multifunction socket

**Fig. 2-2 Charging the rechargeable battery block via multifunction socket**



Connection diagrams for the sensors can be found in Chapter "26 Connection of Sensors".

### 2.2 NivuFlow Mobile Control Elements

The NivuFlow Mobile does not have its own control elements. The entire operation and parameterisation is carried out via the respective smartphone, tablet, notebook and PC. Either the PC mouse is used here or the operation is carried out directly on the touch screen.



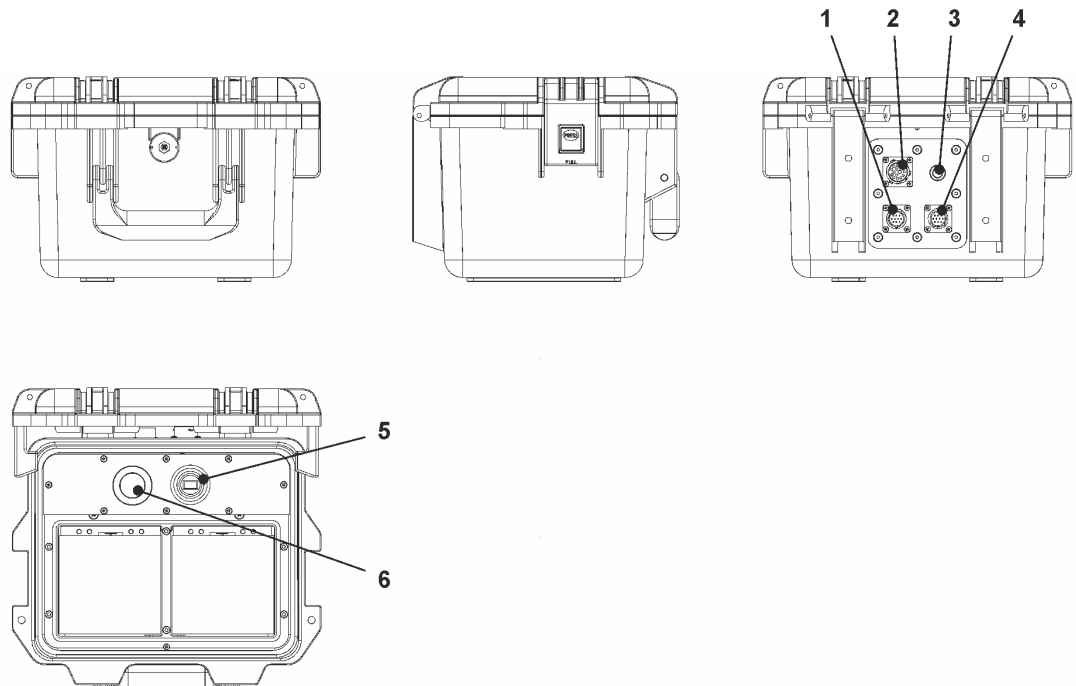
Also observe the instruction manuals for the smartphone, tablet, notebook or PC you are using.



**Fig. 2-3 Ring magnet**

## 2.3 Interfaces

The transmitter is equipped with several interfaces. These are on the back of the enclosure and on the top of the unit respectively.



- 1 Sensor socket v2/h
- 2 Multifunction socket I/O
- 3 2G/3G/4G Antenna socket
- 4 Sensor socket v1
- 5 USB-A interface (accessible when the enclosure cover is open)
- 6 2G/3G/4G SIM card slot (in connection with 2G/3G/4G antenna; accessible when the enclosure cover is open)

**Fig. 2-4 Available interfaces**

## Safety Instructions

### 3 Used Symbols and Signal Words

#### 3.1 Information on the Valuation of Accident Levels



The general warning symbol indicates the risk of personal injuries or death. In the text section the general warning symbol is used in combination with the signal words described below.

**DANGER**

**Warning in high degree of risk**



Indicates a high-risk, **imminently** hazardous situation which will result in death or serious injury if not avoided.

**WARNING**

**Warning in medium degree of risk and personal injury**



Indicates a **possible** danger with medium risk which may result in a life-threatening situation or (severe) bodily injury if not avoided.

**CAUTION**

**Warning in personal injury or property damage**



Indicates a possible danger with moderate risk which may result in minor or moderate personal injury or property damage if not avoided.

**WARNING**

**Danger by electric voltage**



Indicates a medium-risk, **imminently** hazardous situation caused by electric shock which will result in death or (serious) injury if not avoided.



**Important Notice**

Contains information that needs to be highlighted. Indicates a potentially harmful situation that may damage the product or something in its environment if not avoided.



**Note**

Contains tips or information.

### 3.2 Warning Notices on the Device (optional)




#### General Warning Notice

*This symbol refers the operator or user to content in this manual. Consideration of the information contained herein is necessary to maintain the protection provided by the unit for installation and in operation.*




#### Protective earth connection


*This symbol refers to the protective conductor terminal of the device. Depending on the type of installation, the unit may only be operated with a suitable protective earth connection in accordance with applicable laws and regulations.*

	<p>Akkuwechsel nur außerhalb der Ex-Zone zulässig! Akku replacement only outside Ex - Zone!</p>
---	---

	<p>Batterien enthalten Schwefelsäure. Bei Berührung sofort mit viel Wasser spülen. Batteries contain sulfuric acid. In the event of contact, rinse immediately with plenty of water.</p>
---	--

	<p>Elektronik-Abdeckung nicht öffnen! Do not open electronic faceplate!</p>
---	---

	<p>Nur mit feuchtem Tuch reinigen! Clean only with wet cloth!</p>
---	---

	<p>Use of Memory-Stick only outside Ex-Zone admissible!</p>
---	---

## 4 Special safety and Precautionary Measures

When working with the NIVUS equipment, the following safety and precautionary measures must be observed and followed generally and at all times. These warnings and notes are not repeated for each description within the document.

---

### WARNING



#### **Check danger due to explosive gases**

*Before starting assembly, installation and maintenance work, be sure to check that all regulations on safety at work have been observed and that there is no possible risk of explosive gases. Use a gas warner for the check.*

*When working in the sewer system, make sure that no electrostatic charge can occur:*

- *Avoid unnecessary movements to reduce the building-up of static charges.*
- *Discharge any static electricity present on your body before you start installing the sensor.*

*Disregarding may result in personal injury or damage to the system.*

---

### WARNING



#### **Germ Contamination**

*Due to the frequent use of the sensors in the waste water sector, parts can be contaminated with dangerous germs. Therefore, appropriate precautions must be taken when coming into contact with cables and sensors.*

*Wear protective clothing.*

---

### WARNING



#### **Observe Occupational Safety Regulations!**

*Before and during mounting works, compliance with all work safety regulations must always be ensured.*

*Disregarding may lead to personal injury.*

---

### WARNING



#### **Do not disable Safety Devices!**

*It is strictly forbidden to disable the safety devices or to change their mode of operation.*

*Disregarding may result in personal injury or damage to the system.*

---

### WARNING



#### **Disconnect the System from Mains Power**

*Disconnect the system from the mains power before starting maintenance, cleaning and/or repair work (only by qualified personnel).*

*Disregarding may lead to electric shock.*

---



### **Commissioning only by qualified Personnel**

*The entire measuring system may only be installed and commissioned by qualified personnel.*

### **Built-In Backup Battery**

*The backup battery integrated in the measuring instrument may only be replaced by NIVUS or personnel authorised by NIVUS. Otherwise the warranty becomes void.*

## **WARNING**



### **In case of contact with sulphuric acid, rinse immediately with plenty of water**

*Rechargeable/battery blocks contain sulphuric acid. In case of contact, rinse immediately with plenty of water.*

*Disregarding may lead to personal injury.*

## **5 Warranty**

The device was functionally tested prior to shipping. When used for the intended purpose (see Chap. "7 Intended Use") and in compliance with the instruction manual, the applicable (see Chap. "1.1 Applicable Documentation") and the safety information and instructions contained therein, no functional restrictions are to be expected and flawless operation should be possible.



Please also refer to the following chapter "6 Disclaimer".



### **Limitation of Warranty**

*In case of disregarding the safety notes and instructions in this document, the companies of the NIVUS-Group reserve the right to limit the warranty.*

## **6 Disclaimer**

### **The companies of the NIVUS-Group assume no liability**

- for consequential damages resulting from a **change** in this document. The companies of the NIVUS-Group reserve the right to change the contents of the document including this disclaimer without prior notice.
- for personal injury or damage to property resulting from **failure to comply** with the **applicable regulations**. For connection, commissioning and operation of the sensors, all information and higher-level legal regulations of the country (in Germany e.g. the VDE regulations), such as valid Ex regulations as well as the safety and accident prevention regulations applicable to the respective individual case shall be observed.
- for personal injury or damage to property resulting from **improper handling**. For safety and warranty reasons, all work on the equipment that goes beyond the installation and connection measures may only be carried out by NIVUS personnel or by persons or companies authorised by NIVUS.
- for personal injury or damage to property resulting from the operation of the equipment in a **technically faulty** condition.
- for personal injury or damage to property resulting from **improper use**.
- for personal injury or damage to property resulting from failure to observe the **safety instructions** in this instruction manual.
- for missing or incorrect readings due to **improper installation or faulty parameterisation/programming** and for any consequential damage resulting therefrom.

## 7 Intended Use



### Note

*The device is intended exclusively for the purpose mentioned below. Any other use beyond this, any conversion or modification of the instrument without written agreement with the companies of the NIVUS-Group is considered improper use.  
The companies of the NIVUS-Group are not liable for any damage resulting from this.  
The operator alone bears the risk.*

The transmitter NivuFlow Mobile 600 incl. associated sensors is designed for temporary flow measurement of slightly polluted to clear and clean water or equivalent media in full pipes.

The NivuFlow Mobile 600 is designed and produced according to the current state of the art and the recognised safety rules at the time of publication of this document. Nevertheless, risks of personal injury or damage to property cannot be completely ruled out.

The permissible maximum limit values in Chapter "18 Specifications" must be observed. All cases of use deviating from these limit values, which have not been approved by NIVUS GmbH in writing, are excluded from the liability of the NIVUS-Group.

## 8 Ex Protection

The portable transmitter NivuFlow Mobile 600 incl. associated sensors is designed for use in areas with explosive atmospheres of zone 1.

The following conditions must be observed:

- Programming the device under Ex conditions is permissible:
  - with the programmer **inside** the Ex-area, provided that the display and control unit used **has an** Ex-approval.
  - with the programmer **outside** the Ex-area, when the display and control unit used **has no** Ex-approval.
- Maintenance and repair shall only be carried out **outside** the Ex area.
- Rechargeable battery blocks may only be removed/installed and charged **outside** the Ex area.
- In general, only battery blocks approved by NIVUS may be used **within** the Ex area.
- The USB interface is only permitted to be used **outside** the Ex area.
- The SIM card may only be exchanged **outside** the Ex area.
- The device must be secured (after installation at the measurement place) with the pad-lock against unauthorised opening (holes on the side of the housing).

### Approval for Transmitter and Sensors

➡ See Chap. "18 Specifications".



### Validity of the Ex Approval

*The Ex approval is only valid in conjunction with the corresponding marking on the name-plate of transmitter and the sensors.*



### Declarations of Conformity and Test Certificates

*For installation and commissioning, the EU declarations of conformity and test certificates of the approving body must be strictly observed.*



### **Ex Approval for Sensors**

*The Ex approval of the sensors is enclosed with the technical description for transit time sensors.*

## 9 Duties of the Operator



### **Important Notice**

*In the EEA (European Economic Area), the national transposition of the Framework Directive (89/391/EEC) as well as the associated individual directives and, in particular, the Directive (2009/104/EC) concerning the minimum safety and health requirements for the use of work equipment by workers at work, as amended, must be observed and complied with.*

*In Germany, the Ordinance on Industrial Safety and Health must be complied with.*

Obtain the local operating licence and observe the associated conditions. In addition, you must comply with environmental protection requirements and local legal requirements for the following:

- Safety of personnel (accident prevention regulations)
- Safety of work equipment (protective equipment and maintenance)
- Product Disposal (Waste Management Act)
- Materials Disposal (Waste Management Act)
- Cleaning (Cleaning Agents and Disposal)

### **Connections**

As the operator, before activating the device, make sure that the local regulations (e.g. for the electrical connection) have been observed during installation and commissioning.

### **Keep the Instruction Manual for future Reference**

Keep the instruction manual in a safe place and ensure that it is always available and can be consulted by the user of the product.

### **Hand over the Instruction Manual**

When selling the transmitter, this instruction manual must be handed over with it. The manual is part of the standard delivery.



## 10 Requirements for the Personnel

Installation, commissioning and maintenance may only be carried out by personnel who fulfil the following conditions:

- Qualified personnel with appropriate training
- Authorisation by plant operator



---

### **Qualified Personnel**

*in the sense of these instructions or the warnings on the product itself are persons who are familiar with the installation, assembly, commissioning and operation of the product and who have the qualifications appropriate to their job, such as*

- I. Training and instruction or authorisation to switch circuits and devices/systems on and off, to earth and to label them in accordance with the standards of safety technology.*
  - II. Training or instruction in accordance with safety technology standards in maintenance and use of appropriate safety equipment.*
  - III. First Aid Training*
-

## Delivery, Storage and Transport

### 11 Scope of Delivery

The standard delivery of the NivuFlow Mobile 600 comprises:

- Transmitter Type NivuFlow Mobile 600 (according to delivery documents)
- Ring magnet *ZUB0 NFM MAGNET* (Fig. 2-3)
- USB Stick
- Screwdriver for hexagon socket screws
- PU adhesive plates (two pieces; 31x17x3.5 mm) to avoid negative pressure in the case of a possible return (by air freight) to NIVUS (e.g. for maintenance)
- T-shape antenna (antennas are included only for versions with internal 2G/3G/4G modem)
- Padlock (only for Ex versions)
- Instruction manual with EU Declaration(s) of Conformity (printed copy or as link to the NIVUS download centre); It includes all information required for the operation of the NivuFlow Mobile.

Check additional accessories according to the order against the delivery note.

### 12 Inspection upon Receipt

Check the delivery for completeness and apparent intactness immediately after receipt. Report any transport damage immediately to the delivering carrier. Also send a written report to NIVUS GmbH in Eppingen.

Incomplete deliveries must be addressed in writing within two weeks to your responsible representative or directly to the head office in Eppingen.



---

**Observe the two-week deadline**

*Complaints received later will not be recognised.*

---

➡ Before the first use:

1. Open the enclosure cover.
2. If present, remove the PU adhesive plates (two pieces; 31x17x3.5 mm) on the right and left of the enclosure frame (Fig. 15-1 Pos. 1). These were fitted prior to shipment (for air freight) to prevent the enclosure from closing and to eliminate the formation of vacuum in the event of extreme temperature fluctuations during the shipping phase.

### 13 Storage

Observe the minimum and maximum values for external conditions such as temperature and humidity according to Chapter "18 Specifications".

Protect the instrument from corrosive or organic solvent vapours, radioactive radiation and strong electromagnetic radiation.

➡ To store the device:

1. Remove rechargeable battery blocks.
2. If the hoop guards for mounting the Connector Box are fitted, remove them (if space is limited) and fit the rubber buffers instead.



## Rubber buffers

Be sure to screw on the rubber buffers,

- so that the concealed screw-on plates on the back of the NFM do not get lost inside the screw-on channels; the screw-on plates are indispensable as they contain the fastening threads for the protective brackets and additionally serve to stabilise them on the NFM;
- because the rubber buffers are designed as shock protection for the NFM connections and protect them from possible damage.

## 14 Transport

Protect the NivuFlow Mobile from strong impacts, blows, shocks or vibrations by using appropriate safety measures such as straps or similar.

Otherwise, the same conditions apply with regard to external influences as for storage (see Chap. "13 Storage").

## 15 Return

In the event of a return, send the unit to NIVUS GmbH in Eppingen carriage paid and in the original packaging.

Items that have not been sufficiently franked will not be accepted!

In general, a return note (incl. RMA return number) must be requested from the NIVUS customer service before returning the goods. Without this RMA number, the incoming goods cannot be assigned accordingly.



See Chap. "56.2 Customer Service Information".



Before shipment (for air freight):

1. Stick the PU adhesive plates (two pieces; 31x17x3.5 mm) on the right and left of the enclosure frame (Fig. 15-1 Pos. 1). This measure prevents the enclosure from closing and excludes vacuum formation during extreme temperature fluctuations.
2. For transport, place the NivuFlow Mobile safely in the original packaging.

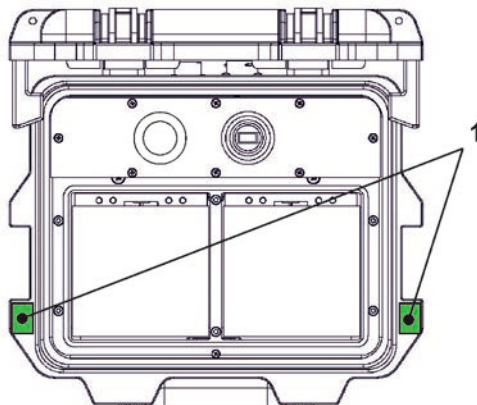
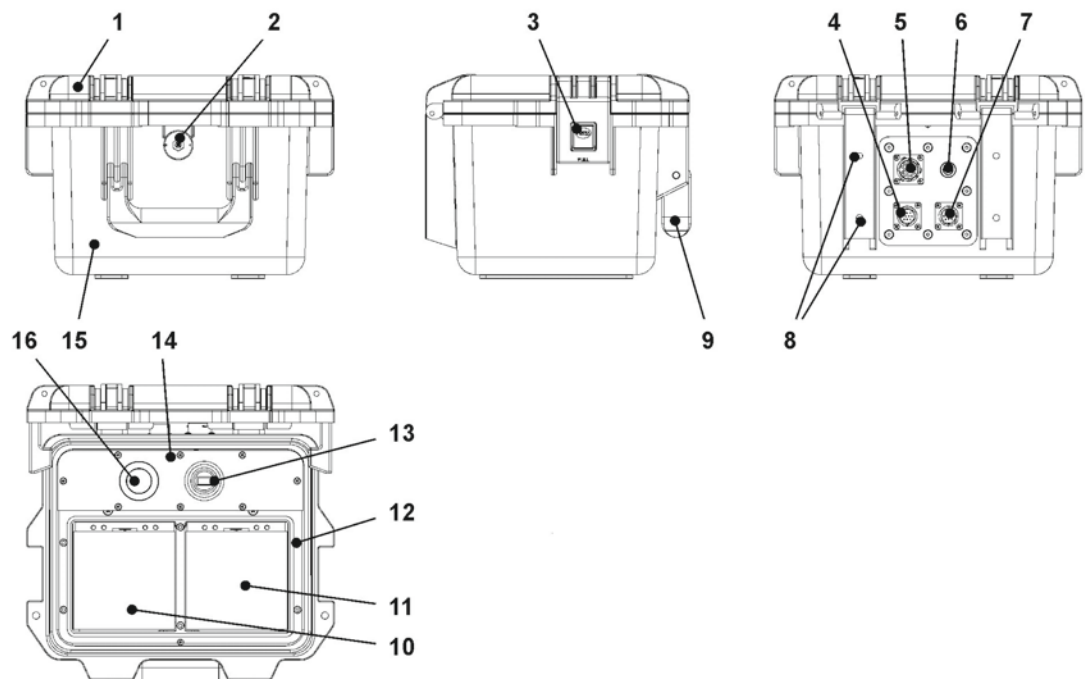


Fig. 15-1 Position to stick on the PU adhesive plates

## Product Specification

### 16 Product Construction and Overview



- 1 Enclosure cover
- 2 LED (status display) and Reed contact (wake-up via magnet)
- 3 Lock (both sides)
- 4 Sensor socket v2/h
- 5 Multifunction socket I/O
- 6 2G/3G/4G Antenna socket
- 7 Sensor socket v1
- 8 Mounting holes for spacer buffers or hoop guards
- 9 Carrying handle
- 10 Left insertion compartment for rechargeable battery block
- 11 Right insertion compartment for rechargeable battery block (possible charging position for battery block)
- 12 Cover (not shown) over battery block with six captive hexagon socket screws
- 13 USB-A Interface
- 14 Transmitter NivuFlow Mobile 600 (IP67)
- 15 Enclosure (IP68 with closed enclosure cover)
- 16 Mobile phone SIM card slot (in connection with 2G/3G/4G antenna)

**Fig. 16-1 Device construction NivuFlow Mobile 600 with enclosure**

## 16.1 Enclosure dimensions

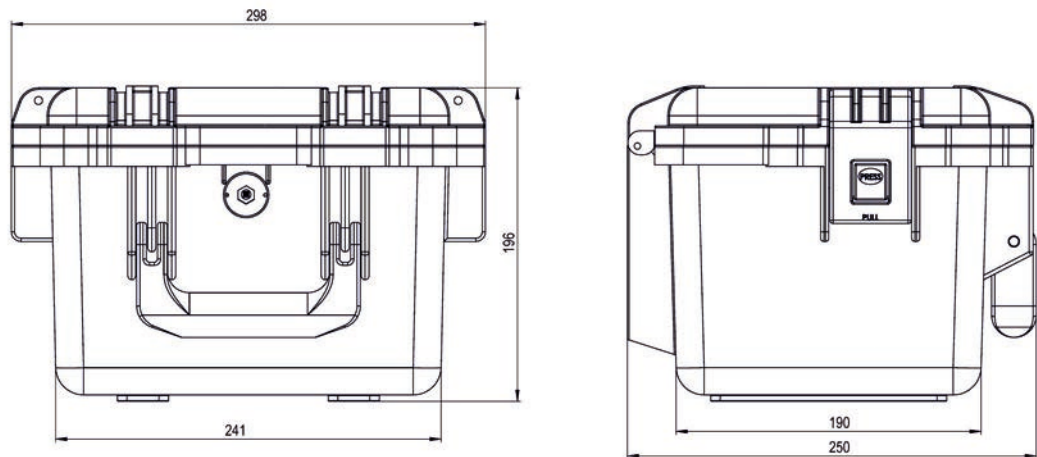
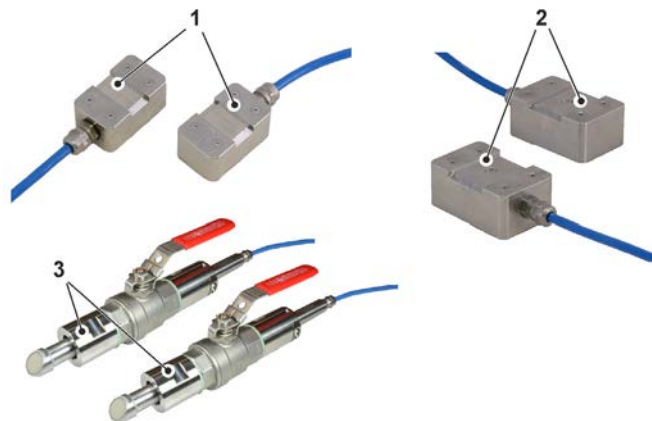


Fig. 16-2 Enclosure

## 16.2 Connectable Sensors/Devices

In the following illustration you will find an overview of the connectable sensors.



- 1 Clamp-on sensor pair Type NIC-CO01
- 2 Clamp-on sensor pair Type NIC-CO50
- 3 Pipe sensor pair Type TSP0 V200 RL0

Fig. 16-3 Connectable sensors

## 17 Device ID

The information in this instruction manual only applies to the device type indicated on the title page. The nameplates are attached to the side of the enclosure and contain the following information:

- Name and address NIVUS GmbH
- CE label
- Marking of the series and type with article number and serial number
- Year of manufacture: the first four digits of the serial number refer to the year of manufacture and the week number (2223.....)
- Ex Protection Label
- Ambient conditions in operation

It is important for all queries and spare parts orders that the article number and serial number of the respective device are specified correctly. This is the only way to ensure proper and fast processing.



Fig. 17-1 Nameplate (Part 1) NivuFlow Mobile 600 (Example Ex Device)



Fig. 17-2 Ex nameplate (Part 2, only for Ex Devices) NivuFlow Mobile 600





### Check nameplates

Check by means of the nameplates whether the supplied device corresponds with your order.



The Declarations of Conformity and the Type Examination Certificate(s) can be found at the end of this instruction manual.

## 18 Specifications

<b>Measurement Principle</b>	Ultrasonic Transit Time Difference
<b>Power Supply, internal</b>	1...2x Rechargeable battery block 12 V / 14 Ah, VRLA-AGM
<b>Enclosure</b>	<ul style="list-style-type: none"> <li>- Material: HPX high-performance synthetic resin</li> <li>- Weight: approx. 4.7 kg (without rechargeable blocks and hoop guards)</li> <li>- Protection: IP68 closed / IP67 with open enclosure cover</li> </ul>
<b>Ex Approvals/ other Approvals</b>	<p>Transmitter:</p> <ul style="list-style-type: none"> <li>- ATEX: TÜV 17 ATEX 196722 X</li> <li>- IECEx: TUN18.0008X</li> </ul> <p> II 2G Ex eb ib [ib] mb IIB T4 Gb</p> <p>Sensors:</p> <ul style="list-style-type: none"> <li>- ATEX: TÜV 12 ATEX 087812</li> </ul> <p> II 2G Ex ib IIB T4 Gb</p>
<b>Operation Temperature</b>	-15 °C...+50 °C
<b>Permanent Storage Temperature</b>	-15 °C...+45 °C
<b>Max. Humidity</b>	90 %, non-condensing
<b>User Indicator</b>	Status LED (RGB)
<b>Operation</b>	Magnet switch; via WLAN with display and operating module (smartphone, tablet, notebook etc.)
<b>Inputs</b>	<ul style="list-style-type: none"> <li>- 2x 0/4...20 mA (active/passive)</li> <li>- 1x 0/4...20 mA (passive)</li> <li>- 1x active digital input</li> <li>- 1x Connection socket for power adapter or alternative power supply</li> </ul>
<b>Outputs</b>	<ul style="list-style-type: none"> <li>- 1x Analogue output 0...5 V / 0...10 V</li> <li>- 1x potential-free digital output as SPDT / bistable</li> <li>- 1x USB-A for read-out of measurement values via USB stick</li> </ul>
<b>External Power Supply / Charging Socket with Rechargeable Battery Block</b>	1x Connection socket for power adapter or alternative power supply
<b>Storage Cycle</b>	1 min. to 60 min., time-cyclical or event-dependent 5 sec. to 60 min., continuous operation
<b>Data Memory</b>	Internal; 182.398 measurement cycles
<b>Data Transmission/ Communication</b>	<ul style="list-style-type: none"> <li>- Via plug-in USB stick</li> <li>- Via WLAN</li> <li>- Option: via 2G/3G/4G</li> </ul>
<b>Charger</b>	<ul style="list-style-type: none"> <li>- Input voltage 100...240 V AC / 50...60 Hz / 50 VA</li> <li>- Protection Class II</li> <li>- Overvoltage Category II</li> <li>- Pollution Degree 2</li> <li>- Ambient Temperature 0 °C...+40 °C</li> </ul>

Tab. 2 Specifications

Transducers



The structure and description of the associated sensors as well as their technical data can be found in the corresponding instructions or technical descriptions.

## 19 Equipment

### 19.1 Device Versions

The portable transmitter is manufactured in different versions. The table below provides an overview on the different versions. The table below provides an overview on the different versions.

The exact device type can be specified by means of the article number.

NFM-	Version	
	<b>06000</b>	Portable flow measurement transmitter for full pipes; function extension through software licences
	<b>000</b>	Standard device
	<b>E00</b>	With ATEX Approval, Zone 1
	<b>0600G</b>	Portable flow measurement transmitter for full pipelines, <b>with remote data transmission</b> ; function extension through software licences
	<b>0E0</b>	With internal modem; modem card Europe <sup>*1</sup> with T-shape antenna ( <i>NFM0 Z ANT1</i> )
	<b>0G0</b>	With internal modem; modem card Global <sup>*2</sup> with T-Shape Antenna ( <i>NFM0 Z ANT1</i> )
	<b>0EG</b>	With internal modem; modem card Europe <sup>*1</sup> with T-Shape Antenna ( <i>NFM0 Z ANT1</i> ) Including NIVUS Connectivity
	<b>0GG</b>	With internal modem; modem card Global <sup>*2</sup> with T-Shape Antenna ( <i>NFM0 Z ANT1</i> ) Including NIVUS Connectivity
	<b>EE0</b>	With ATEX Approval, Zone 1 With internal modem; modem card Europe <sup>*1</sup> with T-Shape Antenna ( <i>NFM0 Z ANT1</i> )
	<b>EG0</b>	With ATEX Approval, Zone 1 With internal modem; modem card Global <sup>*2</sup> with T-Shape Antenna ( <i>NFM0 Z ANT1</i> )
	<b>EEG</b>	With ATEX Approval, Zone 1 With internal modem; modem card Europe <sup>*1</sup> with T-Shape Antenna ( <i>NFM0 Z ANT1</i> ) Including NIVUS Connectivity
	<b>EGG</b>	With ATEX Approval, Zone 1 With internal modem; modem card Global <sup>*2</sup> with T-Shape Antenna ( <i>NFM0 Z ANT1</i> ) Including NIVUS Connectivity
<b>NFM-</b>		

<sup>\*1</sup> Areas of use: Europe, Middle East, Africa, Korea, Thailand, India

<sup>\*2</sup> Areas of use: Global

**Tab. 3 Product Structure NFM 600**



 Accessories see Chapter "60 Accessories".

## 19.2 Add-On Function Licences

The transmitter can be equipped with supplementary functions at extra charge. The following function extensions are currently available as (software) licences:

- FTP/SMTP client for data transmission via FTP server (*NFM LIZENZ FTP*), see Chap. "45 Parameter Menu Communication": **>FTP< / >E-Mail<**
- Data transmission Extended to determine the data depth (*NFM LIZENZ ERW*), see Chap. "43.3 Menu Data Memory": **>Data Depth<**
- Data transmission Expert to determine the data depth (*NFM LIZENZ EXP*), see Chap. "43.3 Menu Data Memory": **>Data Depth<**

 The functions are activated according to Chap. "44.5.5 Feature Unlock".

## Functional Description

### 20 Areas of Use

The NivuFlow Mobile 600 is a portable measuring system for flow measurement. It is designed mainly for use in the measurement of slightly polluted to clean, clear aqueous liquids of the most varied compositions.

It is used in full pipes and rectangular channels of the most varied dimensions.

The NivuFlow Mobile 600 with clamp-on sensors is contactless and therefore pressure-independent. Measurement with clamp-on sensors is only suitable for fully filled pipes.

An overview on connectable sensors/probes can be found in Chapter "16.2 Connectable Sensors/Devices". The use of several sensor pairs serves to record the flow velocity more accurately at one common measurement place.



#### Note on the Measurement Range

The measurement method for determining the flow velocity is based on the principle of the transit time difference. For this system to function, it is essential that there are as few particles and disturbing particles as possible in the medium (dirt particles, gas bubbles or similar). These particles scatter or attenuate the ultrasonic signal and may prevent a measurement.

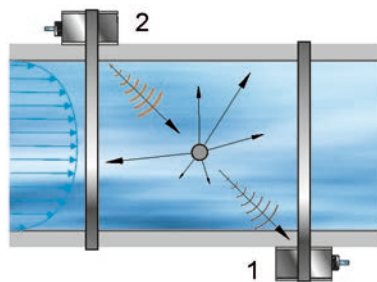
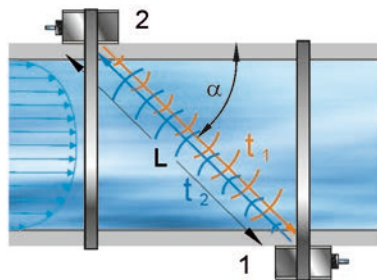


Fig. 20-1 Signal attenuation due to disturbing particles

## 21 Functional Principle

### 21.1 Flow Velocity Determination

The flow velocity is determined using the ultrasonic transit time difference principle.



- 1 Sensor 1
- 2 Sensor 2
- $\alpha$  Defined angle
- $t_1$  Time of impulse **against** the flow direction
- $t_2$  Time of impulse **with** the flow direction

## L Runtime

**Fig. 21-1 Transit time measurement principle with one path**

This measurement principle is based on the direct measurement of the transit time of an acoustic signal between two ultrasonic sensors. These sensors are also called hydroacoustic transducers.

The transit time difference method does not determine the average flow velocity, but the effective velocity of sound propagation upstream (slowed down by the flow) and downstream (accelerated by the flow).

Two sound pulses are sent one after the other and the different transit times between transmitter and receiver are measured.

- The impulse upstream takes a time  $t_1$
- The impulse downstream takes a shorter time  $t_2$

The downstream sound reaches the receiver in a shorter time than the upstream sound. The difference between these transit times is proportional to the average flow velocity in the measurement path.

If both sensors receive the transmitted ultrasonic impulses at the same time, then there is no difference in transit time. No flow is present.

The NivuFlow Mobile 600 works with both clamp-on sensors and wetted sensors. The clamp-on sensors are attached to the outside of the pipe. Here, the penetration of the pipe material is also calculated and taken into account.

In order to be able to determine the flow rate, the cross-section and flow geometry of the pipe, canal or water body must be known. The propagation of the sound is slowed down (upstream) or accelerated (downstream) by the flowing medium depending on the direction.

The transit time difference can be approximated if:

- the main flow direction is known and
- it is assumed that  $C \gg v_{1-2}$

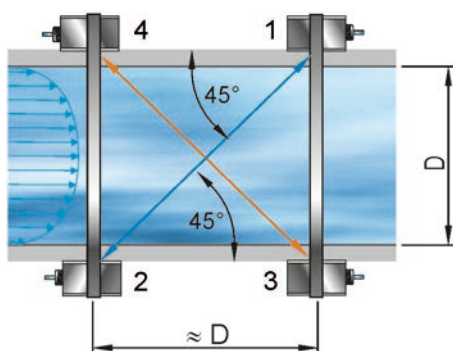
This formula is used for this purpose:

$$\Delta t = \frac{2L_{1-2} \cdot v_{1-2}}{c^2}$$

with:

- $L_{1-2}$  = Length of the acoustic measurement path between sensors 1 and 2
- $C$  = Sound velocity in water
- $v_{1-2}$  = Average value of the flow velocity between sensors 1 and 2 along the measurement path

The more paths are used in the transit time measurement and distributed in the cross-section flowed through, the more accurate the flow can be determined.



- 1 Sensor 1, Path 1
- 2 Sensor 2, Path 1
- 3 Sensor 1, Path 2
- 4 Sensor 2, Path 2
- D Pipe diameter (for sensor installation at 45° angle)

---

**Fig. 21-2 Transit time measurement principle with two paths**

When installing the sensors at a 45° angle, the distance between sensor 1 and sensor 2 or sensor 3 and sensor 4 corresponds approximately to the inner pipe diameter.

When using multi-path systems, assuming equal flow velocities, the deviation angle  $\alpha$  of the flow direction can also be determined in the paths.

This angle is calculated by comparing the measurement values from the individual paths.

## 21.2 Flow Rate Calculation

When using single or multi-path systems in a flat plane under the condition

$$Q = v_{mittel} \cdot A$$

with

- $v_{average}$  = average flow velocity
- $A$  = Area of the flow cross section

a velocity coefficient "k" must be included to compensate for the difference between the measured velocity  $v_g$  and the mean velocity  $v_{average}$  in the cross-section.

$$k = \frac{v_{mittel}}{v_g}$$

According to this, the flow can be calculated with the transit time of the signal as follows:

$$Q = k \cdot A \cdot v_g = k \cdot A \cdot \frac{L_{1-2}}{2 \cdot \cos \Phi_{1-2}} \cdot \left( \frac{1}{t_{2-1}} - \frac{1}{t_{1-2}} \right)$$

## Installation and Connection

### 22 General

#### WARNING



#### **Check danger due to explosive gases**

*Before starting assembly, installation and maintenance work, be sure to check that all regulations on safety at work have been observed and that there is no possible risk of explosive gases. Use a gas warner for the check.*

*When working in the sewer system, make sure that no electrostatic charge can occur:*

- *Avoid unnecessary movements to reduce the building-up of static charges.*
- *Discharge any static electricity present on your body before you start installing the sensor.*

*Disregarding may result in personal injury or damage to the system.*

#### 22.1 Mounting Place

**The following precautions must be taken at the mounting place for safe installation:**

- ➡ Protect the transmitter from direct sunlight. If necessary install a sunshade.
- ➡ Observe the permissible ambient temperature (see Chap. "18 Specifications").
- ➡ Do not expose the transmitter and the connected sensors to strong vibrations or mechanical shocks.

**Necessarily avoid when selecting the mounting place:**

- Corrosive chemicals or gases
- Radioactive radiation
- Installation close to footpaths or travel ways

#### 22.2 Before Installation

#### CAUTION



#### **Rope down the instrument only with suitable safety belts**

*The instrument may only be lowered into shafts using the carrying handle and suitable straps, ropes or similar.*

*Lowering the unit by the sensor cable is not permitted and can lead to cable breakage, leaking plug connection or tearing off the transmitter.*

##### 22.2.1 PU Adhesive Plates on the Enclosure Frame

- ➡ Before using the NivuFlow Mobile 600 for the first time, make sure that the PU adhesive plates on the enclosure frame have already been removed. If not, remove and clean the enclosure frame if necessary.
- ➡ See Chapter "12 Inspection upon Receipt".

##### 22.2.2 Gaskets

- ➡ Check the gaskets on the enclosure cover.  
Before closing the enclosure cover, make absolutely sure that the gasket is clean and undamaged. Therefore:
  1. Remove foreign bodies and dirt.

2. Replace defective gaskets.
3. Treat the seals with silicone grease if necessary.



### **Gaskets**

*Damage to equipment caused by leaking or defective gaskets shall be excluded from the liability of NIVUS GmbH.*

## 22.2.3 Securing the Instrument

- ➡ Secure the transmitter against being washed away.  
When installing the transmitter in shafts or channels that are at risk of flooding, it must be secured against being washed away unintentionally (use a suspension bracket, plastic/stainless steel cable, chain or similar).

## 22.2.4 Connection Sockets

- ➡ Screw open, unused connection sockets on the back of the instrument with the attached covers to protect against dirt or against impacts before installation.

The protection class of the (closed) device is IP68 even with open connection sockets.  
Damaged or lost covers can be reordered from NIVUS at extra costs.

# 23 Electrical Installation/Power Supply

## 23.1 General Information on the Power Supply

### **WARNING**

#### ***Danger by electric voltage***



*Remove the rechargeable battery blocks from the device. If currently there is connection to the mains via the multifunction socket, disconnect it.*

*When working on the electrical connections, there is a risk of electric shock. Observe the electrical data given on the nameplate.*

*Disregarding may lead to personal injury.*



#### **Note**

*Observe the national installation instructions.*

- ➡ Make sure that the following requirements are met:
  1. Please note that installation may only be carried out by qualified personnel.
  2. For the electrical installation, comply with the legal regulations of the respective country (such as VDE 0100 in Germany).
  3. Follow further (country-specific) legal standards, regulations and technical codes.
  4. Complete the installation of the transmitter and the sensors before applying the operating voltage. Check whether the installation is correct.
- ➡ You can find a description on how to connect the sensors starting on page 40.

## CAUTION



### **Do not loosen screws**

*Do not loosen any screws on the transmitter other than the captive hexagon socket screws of the battery compartment cover!*

**Keep the battery compartment closed during operation.**

## 23.2 Rechargeable Battery Block

The NivuFlow Mobile can be operated with only one rechargeable battery block, but two battery blocks are recommended for transmitter operation to ensure the maximum possible battery life.



Rechargeable battery blocks can be purchased from NIVUS (see Chap. "60 Accessories").

The rechargeable battery is placed in the battery compartment. A second slot is provided directly next to it for a second battery block. Which slot is used when using only one rechargeable battery is freely selectable, but restrictions must be expected in charging mode:

- In **charging mode**, only the battery block in the right-hand slot is charged and only up to approx. 75 %.
- In **battery mode**, the battery block with the higher charge level (regardless of the slot) is used until both are at the same voltage level, then both are used simultaneously.

In addition, in the menu >Battery (12V)< the battery type used or the number of rechargeable batteries installed should be entered so that the remaining battery power is correctly displayed in the menu >System< / >Information<.

The battery compartment is closed with a cover and six captive hexagon socket screws.



### **Installation of Spare Parts / Wearing Parts**

*The use of spare/wear parts (e.g. rechargeable battery blocks) that are not approved by NIVUS is generally not permitted.*

*Non-compliance may have negative consequences in terms of warranty and liability. See Chap. "5 Warranty" and "6 Disclaimer".*

## WARNING



### **Do not modify batteries or expose them to fire**

*Do not disassemble, modify or damage the rechargeable batteries to avoid leakage, fire or explosion.*

*Do not heat the batteries above 50 °C and avoid contact with open fire.*

*Disregarding may lead to personal injury.*

### 23.2.1 Removing/installing the battery block

## WARNING



### **Risk of explosion when removing/installing the battery block in Ex areas**

*The battery pack may **only** be removed/installed **outside** the Ex area. **Never within** Ex areas.*

*When removing the battery block, make sure that the poles are not short-circuited by an external object. This could cause very high short-circuit currents to flow, which could lead to excessive heat or fire and destruction of the rechargeable battery block.*

*Observe the specifications on the rechargeable battery block.*

The battery pack can also be replaced in wet weather and rain. The battery compartment is completely separate from the electronic part of the transmitter.

➡ Procedure:

1. Loosen the six captive hexagon socket screws of the cover.
2. Remove the cover.
3. Take out the inserted battery pack on the grip strap.
4. When refitting the battery block, put on the cover and hand-tighten the captive hexagon socket screws of the cover.

### 23.2.2 Charging the battery block

The battery pack is usually delivered empty and must be charged **before first use**.

**NIVUS recommends charging outside the unit via the power adapter/charger to ensure 100 % charging performance. When installed, the battery pack is only charged up to approx. 75 %.**

#### WARNING



***Risk of explosion when removing/installing and charging the battery block in Ex areas***

*The battery pack may **only** be removed/installed and charged **outside** the Ex area. **Never within** the Ex area, as explosion protection is not guaranteed here.*



#### **Power Adapter/Charger**

*Only the mains adapter/charger (Fig. 23-1 Pos. 1; NFM0 ZLAD) (available at a charge from NIVUS GmbH) may be used to charge the battery pack. Observe the specifications on the power adapter/charger.*

*Permissible charging temperature for the rechargeable battery block VRLA-AGM:  
0 °C...+40 °C*

*The use of chargers of other types can lead to the destruction of the rechargeable battery (e.g. through cell leakage, explosion etc.).*



- 1 Power adapter/charger with connection cable for the multifunction socket on the NFM or charging tray
- 2 Indicator LED for charging status

**Fig. 23-1 Power adapter/charger**

➡ When connecting, be sure to observe Chapter "25 10-pole/18-pole Plugs".

Before connecting or disconnecting the power pack/charger (Fig. 23-1 Pos. 1) to or from a battery pack, disconnect it from the mains voltage.

The charging status is indicated with the built-in LED (Fig. 23-1 Pos. 2).

Light colour/indication	Meaning
Yellow	The rechargeable battery is being charged
Green	Trickle charge



LED not lit	Reverse polarity, short circuit or no mains connection; fuse in the unit has blown *1
-------------	---

**Tab. 4 Light colours of the LED**

\*1) If the condition persists, contact the NIVUS customer service (see Chap. "56.2 Customer Service Information").

### Charging the inserted battery block

See Chapter "23.2.4 Operation/Charging with direct connection to mains power".

### Charging the removed battery block

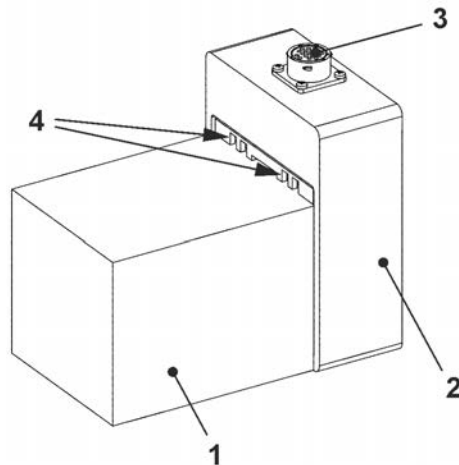
➡ Procedure:

1. Place the charging tray in a protected, dry place on a stable, horizontal surface. Make sure that the charging tray itself is also dry.
2. Take appropriate measures to ensure that no unauthorised persons have access to the units during the charging process.
3. Insert the battery pack (Fig. 23-2 Pos. 1) "lying on its back" (contacts on top) into the charging tray (Fig. 23-2 Pos. 2).



When connecting, be sure to observe Chapter "25 10-pole/18-pole Plugs".

4. Connect the power adapter/charger (with connection cable for the multifunction socket) via the charging socket (Fig. 23-2 Pos. 3) and connect to the mains voltage. The battery block is charged via the charging contacts (Fig. 23-2 Pos. 4). Note the light colour/indication of the LED on the power adapter/charger.
5. At the end of the charging process, to avoid a short circuit at the charging contacts/poles, first disconnect the power adapter/charger from the mains voltage, then remove the battery pack.



- 1 Rechargeable battery block ("lying on its back" - contacts on top - plugged)
- 2 Charging tray
- 3 Charging socket to connect the power adapter/charger
- 4 Charging contacts

**Fig. 23-2 Battery block in the charging tray**

Over time, the battery loses its maximum capacity. This affects the battery life, which cannot be taken into account by the battery life calculation integrated in the NivuFlow Mobile.

At high or low ambient temperatures as well as longer service life, the capacity of the battery block used is reduced.

### *Tips to extend battery life*

- *Store the battery at room temperature:*
  - *Higher temperatures lead to faster battery ageing.*
  - *Lower temperatures lead to a loss of capacity.*
- *Store battery fully charged; fully charge every 6...12 months.*
- *Store the battery "lying on its back" - contacts on top.*
- *Keep the rechargeable battery clean (dust-free) and dry.*



---

### **Rechargeable Battery Life**

*Rechargeable battery blocks are wearing parts and must be replaced when the charging capacity decreases significantly. The battery life depends on the frequency of use.*

*Note the previous "Tips to extend battery life".*

---



---

### **Measurement**

*The battery should be charged before each NivuFlow Mobile measurement.*

*Unused battery packs must be removed from the battery compartment after the last measurement and stored in a dry, frost-free room (see also "Tips to extend battery life").*

---



---

### **Installation of Spare Parts / Wearing Parts**

*The use of spare/wear parts (e.g. rechargeable batteries) that are not approved by NIVUS will invalidate the warranty.*

---



---

### **Disposal of the battery block**

*Always ensure that the battery blocks are disposed of in an environmentally friendly manner.*

***Used battery packs can be returned to the manufacturer or handed in at suitable collection points.***

---

### **23.2.3 Operation/charging via an alternative voltage source**

#### **WARNING**



---

#### ***Risk of explosion when charging the battery pack in Ex areas***

*The battery pack may **only** be removed/installed and charged **outside** the Ex area. **Never within Ex areas.***

---

The NivuFlow Mobile can also be powered by alternative voltage sources (e.g. external rechargeable batteries, solar panels, supply via an external power supply unit) via the multifunction socket.

**WARNING****Explosion hazard during operation with direct external power supply in Ex areas**

The device may **only** be operated **outside** the Ex area with direct **external** power supply. **Never within Ex areas.**

---

In addition to operation, the battery block in the right-hand slot is also charged here. However, only up to approx. 75 % of the total charging power, which is why NIVUS recommends using the charging tray for charging the battery block (see chapter "23.2.2 Charging the battery block").



When connecting, be sure to observe Chapter "25 10-pole/18-pole Plugs".

NIVUS offers a special 2-wire connection cable (*NFM0 ZVER PS*) for the alternative power supply with open cable ends on one side and plug for the multifunction socket on the other side.

The voltage input on the NivuFlow Mobile operates from 12...14.5 V and is protected against short-term overvoltage, overcurrent and reverse polarity.

---

**Battery slots when charging/discharging**

In **charging mode**, only the battery block in the right-hand slot is charged.

In **battery mode** of the rechargeable battery blocks, the battery block with the higher charge level (regardless of the slot) is used until both are at the same voltage level, then both are used simultaneously.

---

## 23.2.4 Operation/Charging with direct connection to mains power

The NivuFlow Mobile can also be operated directly on a mains voltage of 100...240 V AC by means of the combined power supply unit/charger (see Fig. 23-1).

---

**WARNING****Explosion hazard during operation with direct mains power connection in Ex areas**

The unit may **only** be operated **outside** the Ex area with direct mains power connection. **Never within Ex areas.**

---

In addition to operation, the battery block in the right-hand slot is also charged here. However, only up to approx. 75 % of the total charging power, which is why NIVUS recommends using the charging tray for charging the battery block (see chapter "23.2.2 Charging the battery block").

---

**WARNING****Risk of explosion when charging the battery pack in Ex areas**

The battery pack may **only** be removed/installed **outside** the Ex area. **Never within Ex areas.**

---

To charge, insert the battery pack to be charged into the right-hand battery slot and connect the plug of the mains adapter/charger (Fig. 23-1) to the multifunction socket of the NivuFlow Mobile. The battery pack can remain in the NivuFlow Mobile during mains operation, which charges it and also serves as a buffer in the event of a mains failure.



---

**Battery slots when charging/discharging**

In **charging mode**, only the battery block in the right-hand slot is charged.

In **battery mode** of the rechargeable battery blocks, the battery block with the higher charge level (regardless of the slot) is used until both are at the same voltage level, then both are used simultaneously.

---

## 24 Installation of Sensors

This chapter describes the sensors that can be used and their usual locations. The exact description for mounting the sensors is included in the relevant mounting instructions.



---

**Note**

During assembly work, ensure that all work safety regulations are observed.

---

With the transit time difference measurement method, two sensors are always used per measurement path. These sensors must be aligned exactly against each other. Both sensors of a measurement path serve as ultrasonic transmitters as well as ultrasonic receivers. The sensor pairs are matched to each other ex works. The sensors of a path basically have the same cable length. Likewise, the sensors of a path can be identified by the serial number.

### 24.1 Sensor Installation Principles

The placement of the sensors on the system is decisive for the reliability of the measurement results. Therefore, care must be taken to ensure good hydraulic conditions and a sufficient calming section at the installation location. The sensor types and their mounting must be determined individually, depending on the measuring point.



---

The conditions for selecting a calming section and mounting the sensors are described in the respective installation instructions.

---

The measurement place must be parameterised before installation. The corresponding preparation of the measurement place and its dimensions can be taken from the documents of the respective facility.



The parameterisation of the measurement places is described in Chapter "Setting Parameters" starting on page 76.

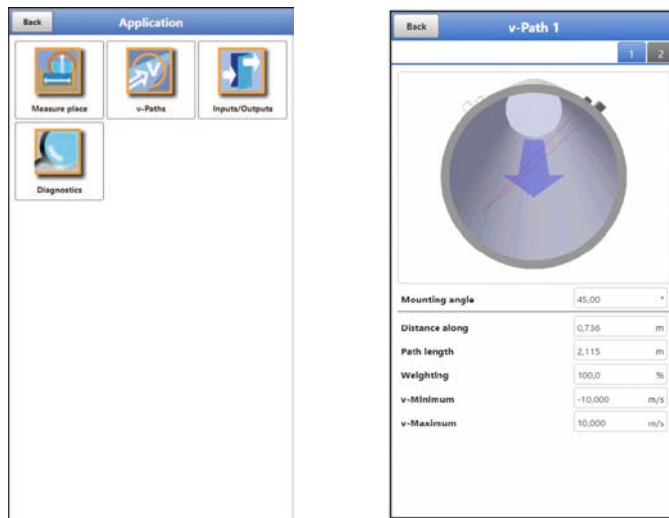
### 24.2 Installation of Clamp-On Sensors

Clamp-on sensors enable contactless measurement in closed and fully filled pipelines. The sensors are clamped onto a pipe from the outside. The liquid is **not** influenced by the measurement and the flow profile of the medium is **not** changed.

Before mounting the clamp-on sensors, the following parameters must first be entered in the transmitter:

- Pipe Material
- Outside pipe diameter
- Wall thickness of the pipe
- Pipe lining material
- Medium to be measured (type of liquid)

Based on this data, the transmitter calculates the exact position data for the sensor mounting. The installation data can be read on the display and operating module (smartphone, tablet, notebook etc.).

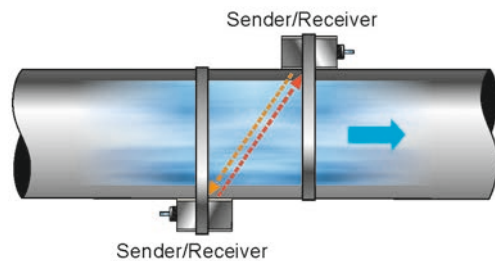


**Fig. 24-1 Output of installation data**

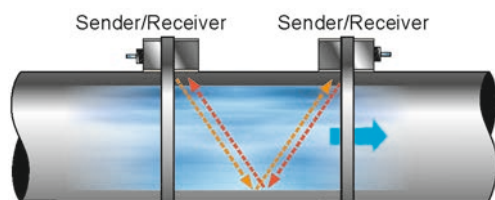
The following path arrangements are common for flow measurement by clamp-on:

- "Diametral \"-Arrangement
- "Diametral V"-Arrangement
- "Diametral W"-Arrangement

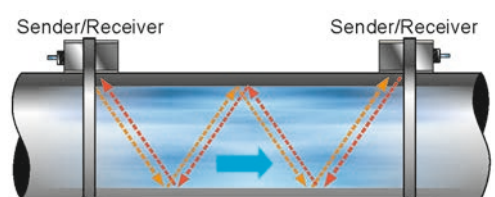
The mounting distance between the two sensors is the "clearance".



**Fig. 24-2 Example "Diametral \"-Arrangement**



**Fig. 24-3 Example "Diametral V"-Arrangement**



**Fig. 24-4 Example "Diametral W"-Arrangement**

### 24.3 Installation of wetted Sensors



#### **Hire a piping specialist**

*Wetted sensors should only be installed by a piping company or an installer. The tightness of the pipes must be guaranteed in any case.*

When measuring with wetted sensors, there is no influence of pipe material and pipe thickness on the measurement.

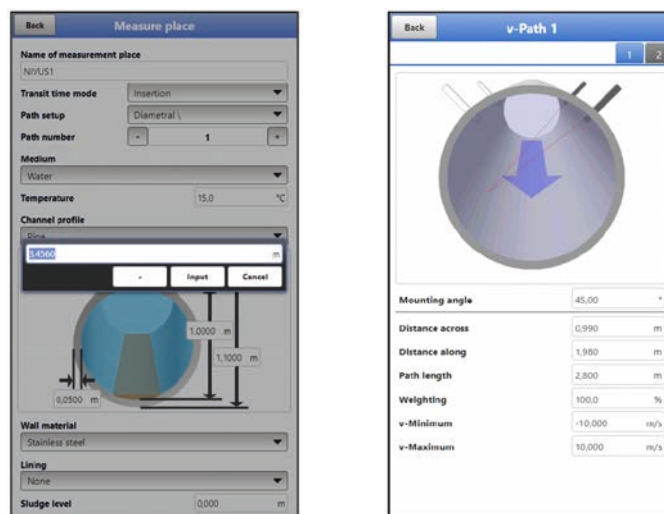
The pipe sensors used are intended exclusively for fully filled pipelines. These sensors are installed in the pipeline from the outside via a welding nozzle (90°) and a fastening element. The measuring paths are always arranged through the centre of the pipe (diametrically).

Pipe sensors or the nozzles for inserting the sensors can be pre-assembled according to specifications. To do this, the preselection of the number and arrangement of paths must first be made and the parameterisation must be carried out in the transmitter.

The parameterisation of the measurement place (selection of the measurement method and number of measurement paths) is done via the menu >Measurement Place<. In the menu >v-Paths< the selection of the sensor position can be entered separately for each measuring path. To change to the other path, select the corresponding tab (1 or 2) at the top right.

The following parameters must be entered:

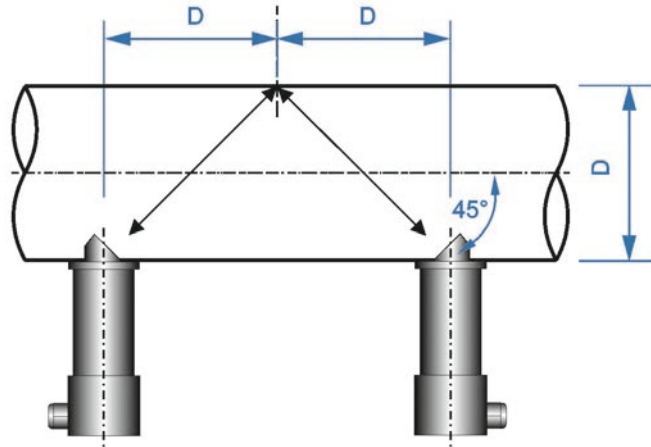
- Pipe Material
- Outside pipe diameter, internal pipe diameter or pipe circumference
- Wall thickness of the pipe
- Medium to be measured



**Fig. 24-5 Input of the pipe dimensions and the mounting angle**

Based on this data, the transmitter calculates the positions of the sensors and the path lengths for the later measurement.

When positioning the sensors/connectors, ensure that 1x the diameter must be established as a parallel distance between the sensor centres for each number of times the pipe is penetrated (guide value). When using NIVUS pipe sensors, the installation angle must be 45°.



---

**Fig. 24-6** Sensor distance - diameter (principle)

## 25 10-pole/18-pole Plugs

### 25.1 Use at NIVUS

In conjunction with the NivuFlow Mobile devices and their interfaces on the rear (see Fig. 2-4 on page 14) NIVUS use 10-pole and 18-pole plugs for connection to the multifunction socket and the two sensor sockets. These can be the sensors, the power supply/charger, the connector box or also pre-assembled cables for overvoltage protection, external inputs/outputs or an external power supply.

➡ See Chap. "60 Accessories".

### 25.2 Special Features and Handling

The connectors for the multifunction and sensor sockets are designed in such a way that they can only be plugged and screwed together with the sockets in a certain position.

However, the advantage of this unmistakable positioning also means that defects can occur if handled incorrectly, such as breaking pins off.

➡ Therefore, proceed as follows when **plugging in** (valid for both types: 10-pole and 18-pole):

1. Place the plug on the socket so that the wide "nose" and the corresponding rectangular recess can be inserted into each other **with a positive fit** (Fig. 25-1 Pos. 1 in colour).
2. Grip the plug only at the **front** ring (Fig. 25-2 Pos. 2) and screw it closed: The pins are pulled into the corresponding openings, the plug is firmly connected to the socket, but the internal components of the plug are not twisted.

When **unscrewing**, proceed in reverse order: Grip the plug only at the **front** ring (Fig. 25-2 Pos. 2) and unscrew it, the plug-socket connection is released, and pull the plug out to the rear **without turning** it.

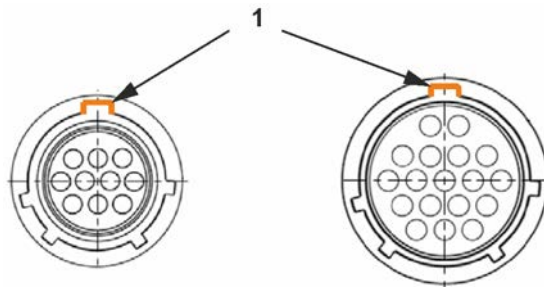


Fig. 25-1 Structure of the connectors (10-pole/18-pole)



Fig. 25-2 Turning the front ring of the plugs (10-pole/18-pole)



## 26 Connection of Sensors

### 26.1 Cable for Sensor Connection

The sensors are equipped ex works with a permanently connected cable.

The sensors of **one** measurement path basically have the same cable length. The cables must not be extended or shortened.

### 26.2 Connecting Sensors

List of connectable flow velocity sensors see Chapter "16.2 Connectable Sensors/Devices".

⇒ When connecting, be sure to observe Chapter "25 10-pole/18-pole Plugs".

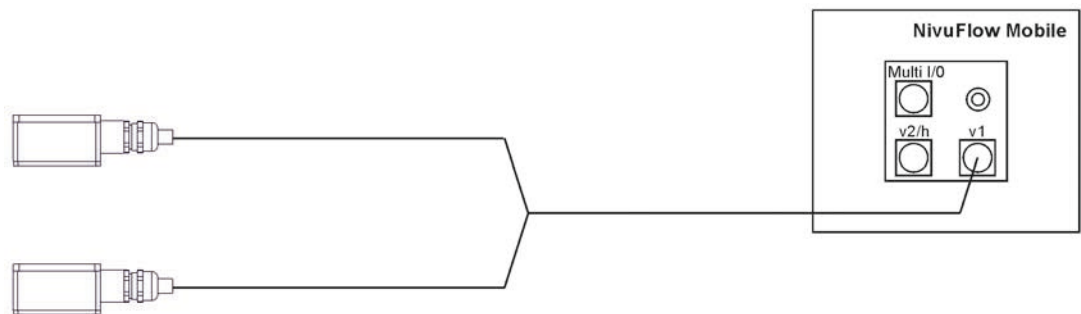


Fig. 26-1 Connection of flow velocity sensors, 1 pair/path

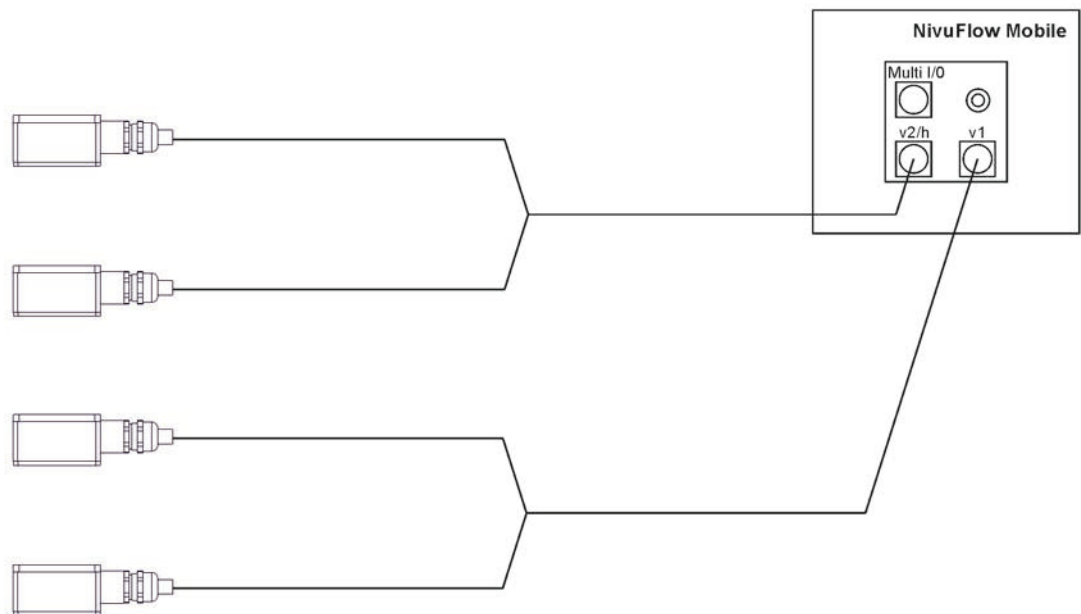


Fig. 26-2 Connection of flow velocity sensors, 2 pairs/paths

### 26.3 Overvoltage Protection Measures

For effective protection of the NivuFlow Mobile with external power supply, it is necessary to secure the unit by means of overvoltage protection devices.

**WARNING**



**Explosion hazard during operation with direct connection in Ex areas**

The device may **only** be operated **outside** the Ex area with a direct mains connection (e.g. plug-in power supply) or direct external power supply (e.g. solar power supply).  
**Never within Ex areas.**

When using a **plug-in power supply unit**, NIVUS recommends the types EnerPro 220Tr / 20kA or EnerPro 220Tr / 5kA (Fig. 26-3) for the mains side.

For **direct external power supply** via 12 V DC (e.g. for solar power supply), use the types DataPro 2x1 12V/12V-11mH-Tr(N) for non-Ex areas. (Fig. 26-4).

⇒ See Chap. "60 Accessories".

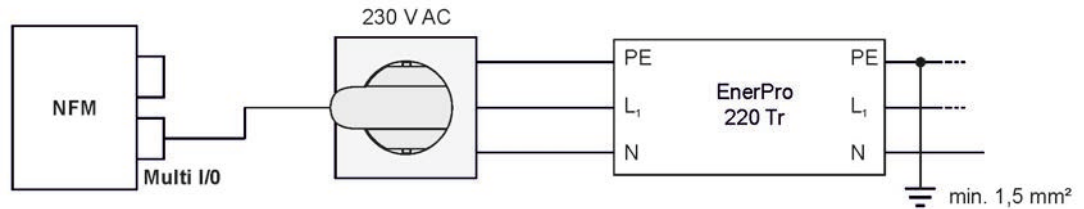


Fig. 26-3 Overvoltage protection for power supply AC general

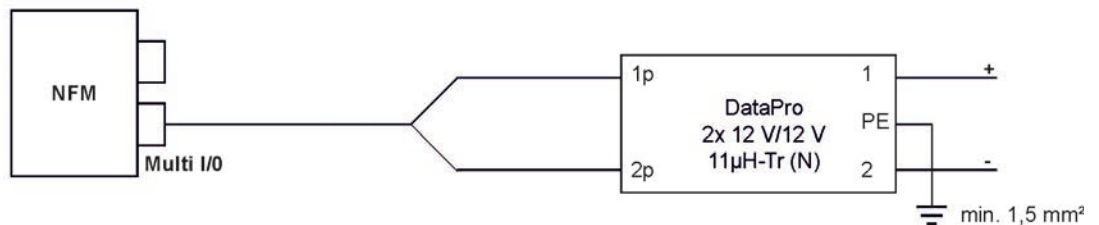


Fig. 26-4 Overvoltage protection for power supply DC general

## 27 Single external Connection for Inputs/Outputs

If, in addition to the flow velocity measurement using the connected sensors, **one** more sensor or actuator is to be connected to the NivuFlow Mobile via the inputs/outputs, this can be done directly with the connection cables for the multifunction socket. Different cables are available depending on the intended use. All are fitted with open cable ends on one side and a plug for the multifunction socket on the other side.

- ⇒ When connecting, be sure to observe Chapter "25 10-pole/18-pole Plugs".
- ⇒ Article numbers see Chapter "60 Accessories".
- ⇒ For more than one external connection see Chapter "28 Connecting the Connector Box for Inputs/Outputs".

## 28 Connecting the Connector Box for Inputs/Outputs

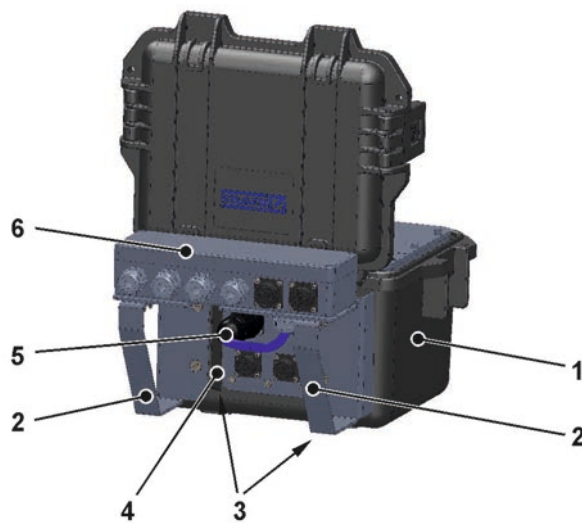
A Connector Box (Fig. 28-1 Pos. 6) is used if, in addition to the max. two paths (four sensors) for the flow velocity sensors on the NivuFlow Mobile 600 (Fig. 28-1 Pos. 1), **more than one** sensor or actuator is to be connected via the inputs/outputs.

⇒ For only one external connection see Chapter "27 Single external Connection for Inputs/Outputs".



### Connector Box Fastening options

*The Connector Box can either be mounted directly on the NivuFlow Mobile in conjunction with the hoop guards (Fig. 28-1 Pos. 2) or attached/stored at another location.*



**Fig. 28-1 NFM with Connector Box (principle)**

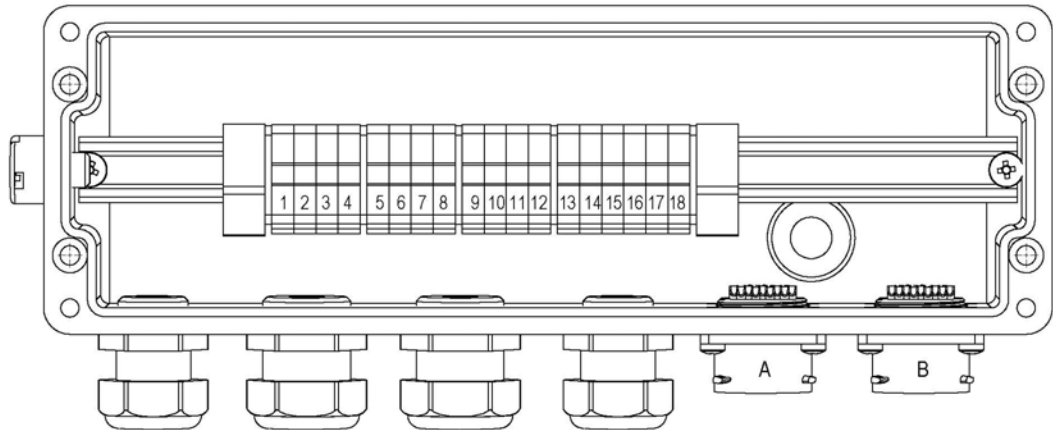
➡ Procedure for fastening the Connector Box on the NivuFlow Mobile:

1. Unscrew the rubber buffers (not shown) on the back of the NivuFlow Mobile (Fig. 28-1 Pos. 1).  
The two screw-on plates (Fig. 28-1 Pos. 3) (now loose) in the screw-on channels (Fig. 28-1 Pos. 4) and the rubber buffers are needed again in the next step.
2. Attach the hoop guards (Fig. 28-1 Pos. 2) and the screw-on plates (Fig. 28-1 Pos. 3) to the NivuFlow Mobile with the rubber buffers.
3. Fasten the Connector Box (Fig. 28-1 Pos. 6) to the hoop guards with the screws supplied.
4. Connect the sensors in the Connector Box according to the terminal wiring plan (Fig. 28-2).

⇒ When connecting, be sure to observe Chapter "25 10-pole/18-pole Plugs".

5. Insert the plug (Fig. 28-1 Pos. 5) of the Connector Box connection cable into the multifunction socket on the NivuFlow Mobile.

⇒ Article numbers see Chapter "60 Accessories".



- A = Connection OFR sensor; function only with NFM550  
 B = Input external power supply 12...14 V DC

Clamp	Function	description
1	Power Supply +	Internal wiring OFR sensor; function only with NFM550
2	GND	
3	RxTx-	
4	RxTx+	
5	Shield	
6	AI1-	Analogue Input 1; 0/4...20 mA; supplied by NFM
7	AI1+	
8	AI2-	Analogue Input 2; 0/4...20 mA; supplied by NFM
9	AI2+	
10	AI3+	+ Analogue Input 3; 0/4...20 mA; externally supplied
11	AO+	+ Analogue Output 1; 0...10 V DC
12	GND AI3/AO	Ground Analogue Input 3 and Analogue Output 1
13	DI+ 3.3 V	Digital input 1
14	GND	Ground Digital Input 1 and external power supply
15	12...14 V DC (+)	External power supply + (only input)
16	Foot Contact (COM)	Digital Output 1
17	Normally Open (NO)	
18	Normally Closed (NC)	

**Fig. 28-2 Terminal wiring Connector Box**

**Connection B** on the Connector Box is used for the external supply of the transmitter NFM (with 12...14 V DC) when the Connector Box is plugged in via the power supply unit/charger (see Chap. "23.2.2 Charging the battery block") or via the 2-wire connection cable (see Chap. "23.2.3 Operation/charging via an alternative voltage source").

## 29 Antenna for 2G/3G/4G Remote Data Transmission

For 2G/3G/4G remote data transmission, an antenna is required:

- T-Shape Antenna (included in the delivery)
- Rod antenna (in connection with antenna adapter)

The rod antenna as a second option is for applications where the conditions for data transmission in the channel are particularly poor. This rod antenna can be inserted through a hole in the canal wall (must be placed individually) and should thus enable better data transmission. This rod antenna can be purchased from NIVUS at extra costs.

➡ See also Chap. "11 Scope of Delivery" and "60 Accessories".

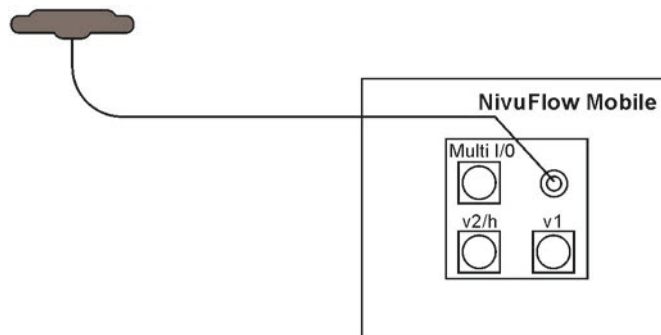


### **Only connect antennas approved for this product**

*The antenna socket is designed to be intrinsically safe. Only the enclosed T-shape antenna or the types NFM0 Z ANT<sub>x</sub> with the longer connection cables or the rod antenna NLM0 ANT 900 FME may be connected to the NivuFlow Mobile.*

### 🔄 Procedure for connection and installation of the **T-Shape Antenna**:

1. Plug the antenna cable into the socket on the unit (Fig. 29-1) and tighten the screw connection manually.



**Fig. 29-1 Connecting the 2G/3G/4G T-Shape Antenna**

2. Place the antenna at the highest possible position in the shaft or on the dirt trap.

*General Note on the Antenna:*

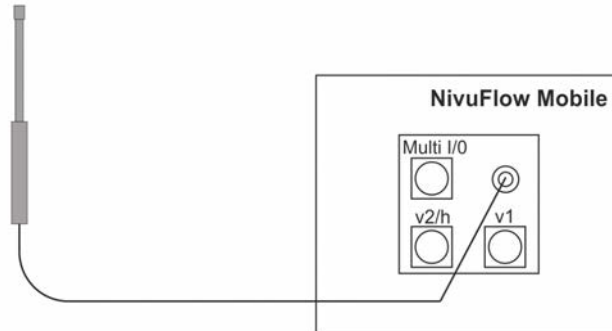
*The T-Shape mobile phone antenna must be positioned to ensure that no person is permanently (longer than 6 minutes) at a distance of less than 25 cm from the antenna.*

*When the device is operating normally, there is usually no health risk even at smaller distances, as the device only transmits for a short time on the mobile radio interface, but this distance should still be observed as a precautionary measure.*

3. If the unit is used in the manhole, close the manhole cover to check whether the data transmission also works when the manhole cover is closed.
4. Use the parameterisation menu Communication to set up a test connection (see Chap. "45 Parameter Menu Communication", >Modem Status< / >Set Up Test Connection<) to check the data transmission.  
If the connection is poor, change the position of the antenna until data transmission works.

➡ Procedure for connection and installation of the **Rod Antenna**:

1. Screw the rod antenna into the FME socket of the antenna cable adapter.
2. Plug the antenna cable into the socket on the unit (Fig. 29-2) and tighten the screw connection manually.



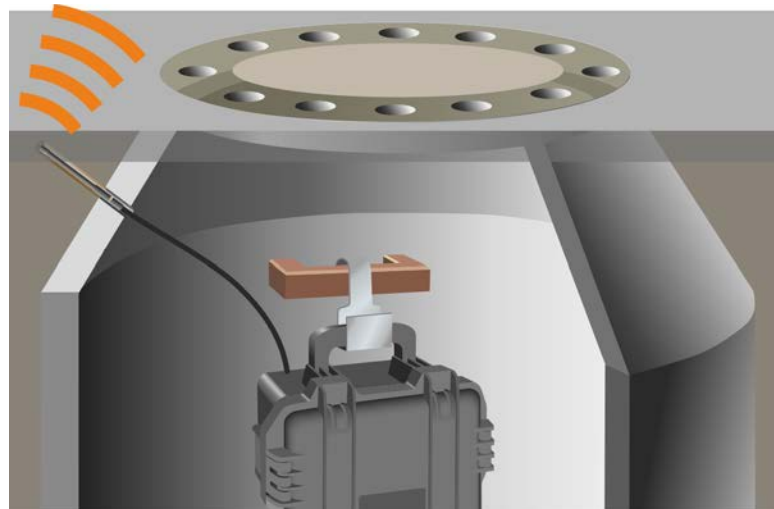
**Fig. 29-2 Connecting the 2G/3G/4G rod antenna**

3. Find a suitable position in the upper part of the channel to plug in the antenna. Drill diagonally through the channel shaft wall with a reinforced concrete break-through drill Ø 12 mm: Drill depth min. 25 cm to approx. 6...12 cm below the top edge of the road.

*General Note on the Antenna:*

*The mobile phone rod antenna must be positioned to ensure that no person is permanently (longer than 6 minutes) at a distance of less than 25 cm from the antenna.*

*When the device is operating normally, there is usually no health risk even at smaller distances, as the device only transmits for a short time on the mobile radio interface, but this distance should still be observed as a precautionary measure.*



4. Insert the rod antenna with the tip first to the end of the hole.
5. Use the parameterisation menu Communication to set up a test connection (see Chap. "45 Parameter Menu Communication", >Modem Status< / >Set Up Test Connection<) to check the data transmission. If the connection is poor, change the position of the antenna until data transmission works.

## Commissioning

### 30 Notes to the User

Before connecting and operating the NivuFlow Mobile, the instructions below shall be followed.

This instruction manual contains all information required for parameterisation and use of the transmitter. The instruction manual is intended for qualified expert personnel. Appropriate knowledge in the areas of measurement systems, automation technology, control engineering, information technology and wastewater hydraulics are preconditions for putting the NivuFlow Mobile into operation.

Read this instruction manual carefully to ensure proper functioning of the NivuFlow Mobile. Connect the NivuFlow Mobile according to Chapter "26.2 Connecting Sensors".

If you have any questions regarding installation, connection or parameter setting, please contact our hotline at:

- +49 7262 9191-955

#### General Principles

Commissioning of the measurement system shall not be carried out before installation has been finished and verified.

Observe the information in this instruction manual to prevent incorrect or faulty or parameterisation. Familiarise yourself with the operation of the transmitter before you start with the parameterisation.

After connecting the transmitter and sensors (according to Chapters "24 Installation of Sensors" and "26 Connection of Sensors") the measurement place must be parameterised.

To do this, in most cases it is sufficient to specify:

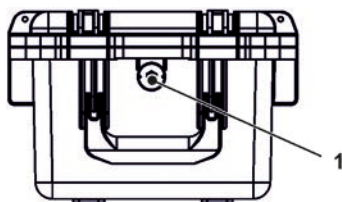
- Measurement place geometry and dimensions
- Sensors used and their positioning
- Display units
- Storage mode settings

The user interface of the NivuFlow Mobile is easy to understand. You can quickly make the basic settings yourself.

For faster commissioning, a start assistant is also available. This guides the user in simple steps through the most important points of parameterisation (see Chapter "48 Parameter Menu Quick Start").

### 31 Lighting System of the Status LED on NivuFlow Mobile

The status LED (Fig. 31-1) on the front of the NivuFlow Mobile lights up during operation according to a predefined system that allows conclusions to be drawn about the current status of the device.



**Fig. 31-1 LED on the front of the NFM**

If the NFM works without restrictions, the LED lights up **green**: 1x long, pause, 5x short (Tab. 5 No. 1).

If at least one error message is present, the same rhythm applies, but the LED then lights up **red** for a long time (1.5 s), followed by an error code (Tab. 5 No. 9).

**Blue** light in the pause between the first long light and the five consecutive ones indicates the number of users logged in: 1x for each user (up to max. four logged-in users are possible) (Tab. 5 Nr. 2...5).

➡ See also Chap. "39 General Programming".

The LED lights up **white** (Tab. 5 No. 14 Special code: Switch-on sequence without USB stick) when the system is booted, e.g. after plugging in the rechargeable/battery pack or after a firmware update.

*Background info:*

*The colour white is generated by simultaneously illuminating the colours red, green and blue. So white also shows that all colours of the LED are working correctly.*









➡ See also Chap. "44.5.6 Update NivuFlow".

Depending on the status of the transmitter, the colours **yellow**, **magenta/pink** and **cyan/turquoise** are also possible. Details see Tab. 5 No. 6, 10 and 11.

**Explanation** of the following table of possible light combinations:

- LED oval means 1.5 s active (on or off)
- LED round means 0.5 s active (on or off)
- Each message consists of a start identifier (LED 1.5 s off / 1.5 s on) and a sequence of five short flashing codes (LED 0.5 s on / 0.5 s off) containing the actual information.
- The special codes (Tab. 5 No. 12, 13 and 14) consist of a start identifier (LED red 0.5 s / green 1.5 s) and a sequence of long phases (LED 1.5 s on or off).

**Possible light combinations of the status LED**

1	OK: Normal operation; no WLAN or modem connections (0 users)	
2	OK: 1 WLAN or modem connections (1 users; blue)	
3	OK: 2 WLAN or modem connections (2 users; blue)	
4	OK: 3 WLAN or modem connections (3 users; blue)	
5	OK: 4 WLAN or modem connections (4 users; blue)	
6	Error: Automatic sensor detection	
7	Error: Battery	
8	Error: HART	



9	Error: Other, undefined error	
10	Warning: Data backup (export) to USB stick is running	
11	Warning: Firmware update (bootloader ext. FLASH) is running	
12	Special code: Start bootloader without USB stick	
13	Special code: Firmware update (bootloader int. FLASH) is running	
14	Special code: Switch-on sequence without USB stick	

Tab. 5 Lighting system of the status LED

## 32 Connection Setup

### 32.1 Common

The entire operation of the NivuFlow Mobile is done via a commercially available smartphone/tablet or via a notebook/PC. The operation of the display and operating module used is carried out in accordance with the manufacturer's instructions for the respective unit.

The procedure for establishing a connection for the Android, iOS and Windows operating systems is described below.

### 32.2 Android Operating System

➡ Preparations on NivuFlow Mobile:

1. Ensure power supply: at least one charged rechargeable battery block in the unit or alternatively via the multifunction socket (see Chapter "23.2.3 Operation/charging via an alternative voltage source").  
If the rechargeable battery block is now plugged in or the voltage is newly added and the connection setup is continued within the following approx. five minutes, the following work step with the "Wake-Up" can be skipped.
2. "Wake up" NivuFlow Mobile: to do this, hold the supplied magnet (Fig. 32-1 Pos. 2) in front of the Reed contact (Fig. 32-1 Pos. 1; at the front of the NFM) until the LED lights up.

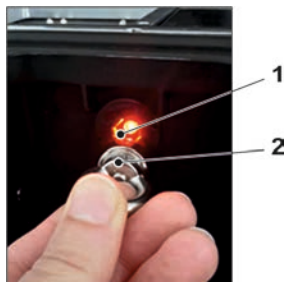
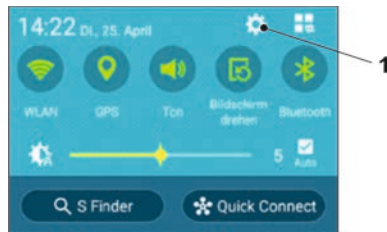


Fig. 32-1 Waking up the NivuFlow Mobile

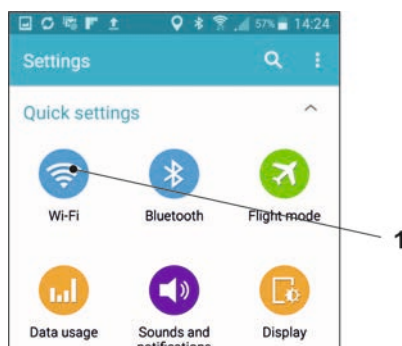
➡ Work steps on the display and operating module (smartphone, tablet, notebook, PC etc.):

1. Start the display and operating module.
2. Open the corresponding menu using the Settings symbol (Fig. 32-2 Pos. 1).



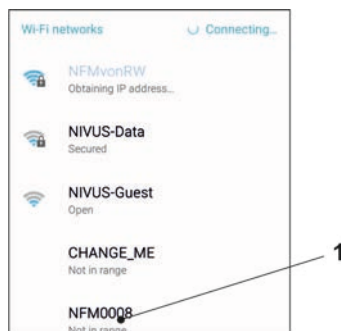
**Fig. 32-2 Settings symbol**

3. Select WLAN (Fig. 32-3 Pos. 1).



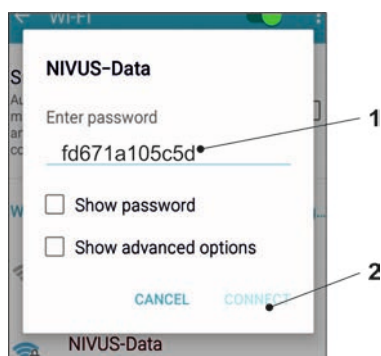
**Fig. 32-3 WLAN symbol**

4. In the WLAN list select the NFM (Fig. 32-4 Pos. 1) with the corresponding SSID (delivery status = serial number).



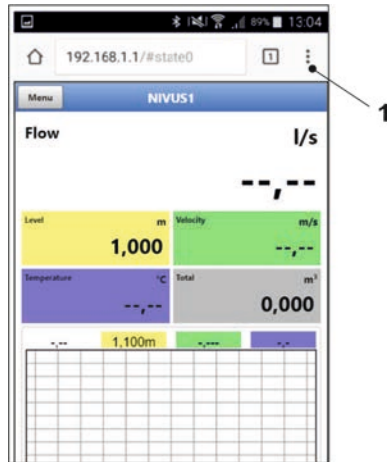
**Fig. 32-4 WLAN list**

5. Enter the password for server access (delivery status = PUK) (Fig. 32-5 Pos. 1) and connect (Fig. 32-5 Pos. 2).



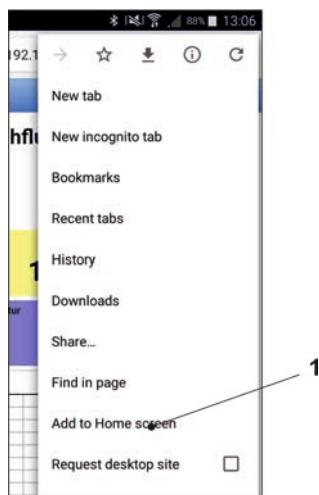
**Fig. 32-5 Enter password (here fd671a105c5d as example) and connect**

6. Start Internet browser.
7. Enter the IP address "192.168.1.1" in the address field and open.  
After successful connection the display of the NivuFlow Mobile (Fig. 32-6) is shown.



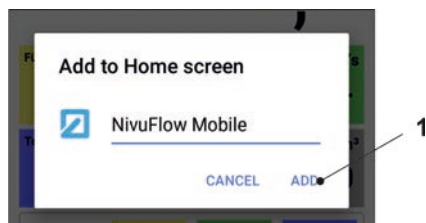
**Fig. 32-6 Indication of NFM display in the browser**

8. To set up a link on the "Home screen" (for direct access), tap the icon for more tabs (Fig. 32-6 Pos. 1) and settings and select "Add to start screen" (Fig. 32-7 Pos. 1).



**Fig. 32-7 Add to start screen**

9. Confirm with "Add" (Fig. 32-8 Pos. 1).



**Fig. 32-8 Confirm adding**

The shortcut (Fig. 32-9 Pos. 1) appears on the start screen and can be used for immediate entry without entering the IP address.

This link can also be used with any other NivuFlow Mobile transmitter after the respective selection in the WLAN list.



Fig. 32-9 Link on the start screen

### 32.3 iOS Operating System

➡ Preparations on NivuFlow Mobile:

1. Ensure power supply: at least one charged rechargeable battery block in the unit or alternatively via the multifunction socket (see Chapter "23.2.3 Operation/charging via an alternative voltage source").  
If the rechargeable battery block is now plugged in or the voltage is newly added and the connection setup is continued within the following approx. five minutes, the following work step with the "Wake-Up" can be skipped.
2. "Wake up" NivuFlow Mobile: to do this, hold the supplied magnet (Fig. 32-10 Pos. 2) in front of the Reed contact (Fig. 32-10 Pos. 1; at the front of the NFM) until the LED lights up.

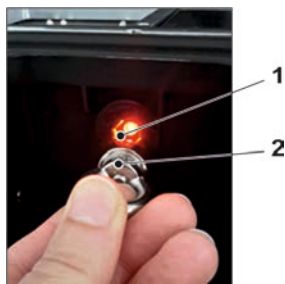


Fig. 32-10 Waking up the NivuFlow Mobile

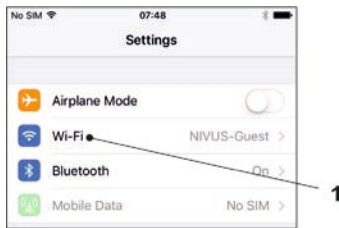
➡ Work steps on the display and operating module (smartphone, tablet, notebook, PC etc.):

1. Start the display and operating module.
2. Open the corresponding menu using the Settings symbol (Fig. 32-11 Pos. 1).



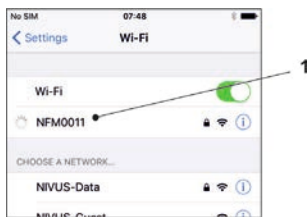
**Fig. 32-11 Settings symbol**

3. Select WLAN (Fig. 32-12 Pos. 1).



**Fig. 32-12 WLAN symbol**

4. In the WLAN list select the NFM (Fig. 32-13 Pos. 1) with the corresponding SSID (delivery status = serial number).



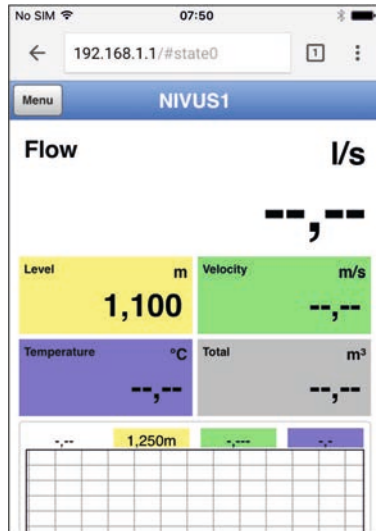
**Fig. 32-13 WLAN list**

5. Enter the password for server access (delivery status = PUK) (Fig. 32-14 Pos. 2) and connect (Fig. 32-14 Pos. 1).



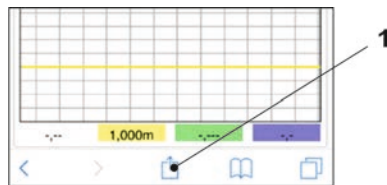
**Fig. 32-14 Enter password and connect**

6. Start Internet browser.
7. Enter the IP address "192.168.1.1" in the address field and open.  
After successful connection the display of the NivuFlow Mobile (Fig. 32-15) is shown.



**Fig. 32-15 Indication of NFM display in the browser**

8. To set up a link on the Home screen (for direct access), tap the "Provide" icon (Fig. 32-16 Pos. 1).



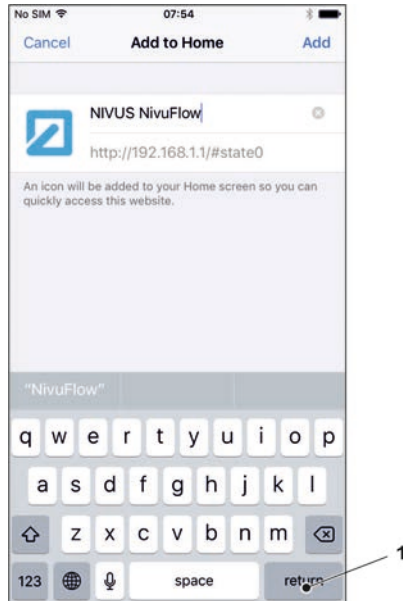
**Fig. 32-16 Set up link**

9. Select "To Home screen" (Fig. 32-17 Pos. 1).



**Fig. 32-17 To Home screen**

10. Confirm with "Return" (Fig. 32-18 Pos. 1).



**Fig. 32-18 Confirm adding**

The shortcut (Fig. 32-19 Pos. 1) appears on the start screen and can be used for immediate entry without entering the IP address.

This link can also be used with any other NivuFlow Mobile unit after the respective selection in the WLAN list.

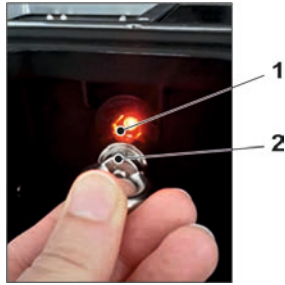


**Fig. 32-19 Link on the start screen**

## 32.4 Windows Operating System

### 🔄 Preparations on NivuFlow Mobile:

1. Ensure power supply: at least one charged rechargeable battery block in the unit or alternatively via the multifunction socket (see Chapter "23.2.3 Operation/charging via an alternative voltage source").  
If the rechargeable battery block is now plugged in or the voltage is newly added and the connection setup is continued within the following approx. five minutes, the following work step with the "Wake-Up" can be skipped.
2. "Wake up" NivuFlow Mobile: to do this, hold the supplied magnet (Fig. 32-20 Pos. 2) in front of the Reed contact (Fig. 32-20 Pos. 1; at the front of the NFM) until the LED lights up.



**Fig. 32-20 Waking up the NivuFlow Mobile**

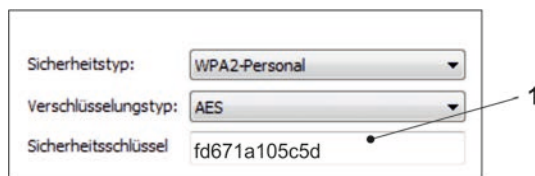
➡ Work steps on the display and operating module (smartphone, tablet, notebook, PC etc.):

1. Start the display and operating module.
2. Go to the overview of the available (WLAN) networks (Fig. 32-21 Pos. 2).
3. In the WLAN list select the NFM (Fig. 32-21 Pos. 1) with the corresponding SSID (delivery status = serial number).



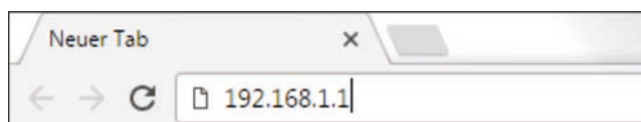
**Fig. 32-21 (WLAN) Network list**

4. Enter security key (password) (delivery status = PUK; here fd671a105c5d as example) (Fig. 32-22 Pos. 1) and connect.



**Fig. 32-22 Enter security key and connect**

5. Start Internet browser.



**Fig. 32-23 Address field**

6. Enter the IP address "192.168.1.1" in the address field (Fig. 32-23) and open. After successful connection the display of the NivuFlow Mobile (Fig. 32-24) is shown.





**Fig. 32-24 Indication of NFM display in the browser**

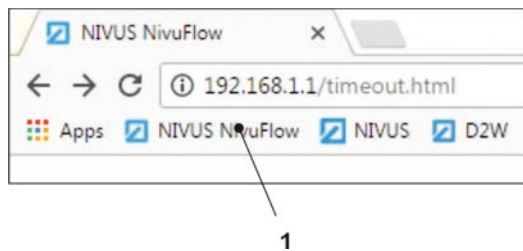
7. To set up a favourite in the browser (for direct access), tap the star for "Favourites" (Fig. 32-25 Pos. 1) (Google Chrome is used as an example) and confirm with "Done" (Fig. 32-25 Pos. 2).



**Fig. 32-25 Setting up favourite**

The bookmark appears on the bookmark bar (Fig. 32-26 Pos. 1) and can be used for immediate access by simply selecting it without entering the IP address.

This link can also be used with any other NivuFlow Mobile unit after the respective selection in the WLAN list.

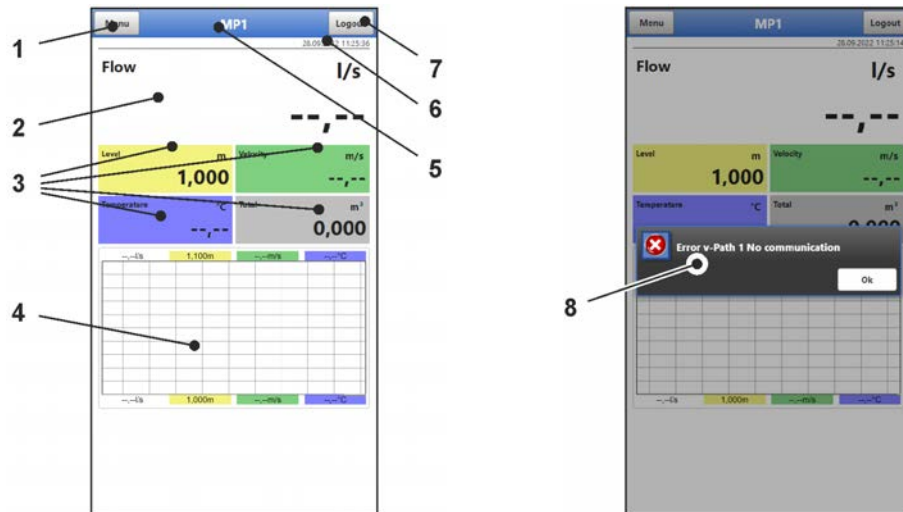


**Fig. 32-26 Link in the bookmarks bar**

### 33 Menu Control/Overview

#### 33.1 Overview Display

Via the NIVUS display you can see at any time where you are in the menu and which entries you are currently editing.

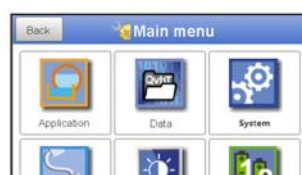


- 1 Menu / Back (depending on the display view)
- 2 Display Area 1 (output field 1 for the flow measurement)
- 3 Display Area 2 (output field 2...5 for level, average velocity, medium temperature and totaliser)
- 4 Display Area 3 (trend graph on level, velocity, medium temperature and flow rate)
- 5 Measurement place name or designation of the opened menu and service symbol, if applicable
- 6 Date and Time
- 7 Logout (disconnecting the operating and display module from the transmitter; the transmitter continues to run with the last saved settings)
- 8 Possible error message, information or display for active service mode (one-time display, directly after opening as a separate window in the centre of the display; close with "Ok")

**Fig. 33-1 Display view**

If the symbol of a hand with a spanner is shown in the upper area of the display next to the measurement place name or next to the designation of the opened menu (Fig. 33-2), the transmitter is in service mode.

Usually the service mode is only selected when the NIVUS support (consultation with service/hotline) has direct or remote access to the transmitter.



**Fig. 33-2 Service symbol**

The transmitter remains in service mode until the session ends.

The session can be ended by:

- Closing the browser
- Selecting "Logout" in the top right display corner
- Setting the transmitter to powerdown mode (via >System< / >Service< / >Powerdown<)
- The automatic idle state of the transmitter due to longer inactivity (no more action by the user)

Alternatively, the service mode can also be closed directly by selecting the field "Service Level" and

- entering an incorrect password (any letter / any number) and confirming with "Enter" or
- without entering a password and confirming the empty field with "Enter".

## 33.2 Save Parameters

After changing parameters and scrolling back via the menu field, the changed parameters must be saved before the changes take effect. After saving, the status message "Successful" appears.

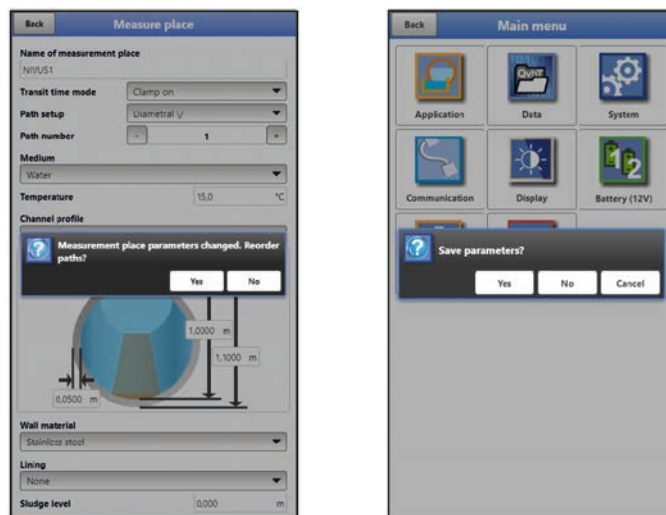


Fig. 33-3 "Realign Paths" and "Save Parameters"



Procedure for saving see Chapter "39.1 Save Parameters".

### 33.3 Menus

All menus are described in a logical programming sequence in chapter "Setting Parameters" starting on page 76.

There are eight basic menus available in the main menu. These become visible and selectable by selecting the "Menu" field (from the main display) or the "Back" field (from within the submenus).

In detail these are:

<b>Application</b>	Guides commissioning personnel through the complete parameterisation of measurement place dimensions, sensor selection, analogue and digital inputs/outputs and diagnostics.
<b>Data</b>	<ul style="list-style-type: none"> <li>- Graphical representation of the progression of flow rate, level and (average) flow velocity</li> <li>- Tabular display of 24-hour daily totals</li> <li>- Saving of data</li> <li>- Saving and loading of parameters</li> </ul>
<b>System</b>	<ul style="list-style-type: none"> <li>- Retrieval of basic information (serial number, version, item number etc.) on the transmitter (required for queries with NIVUS GmbH)</li> <li>- Setting the language and date format under &gt;Country Settings&lt;</li> <li>- Setting the system time and time zones under &gt;Time/Date&lt;</li> <li>- Error messages under &gt;Error Messages&lt;</li> <li>- Service Levels</li> <li>- Configure Storage Cycle</li> <li>- Parameter/System Reset</li> <li>- Feature Unlock</li> <li>- Shut Down Device (Powerdown)</li> <li>- Information about the rechargeable battery blocks and the current capacity</li> </ul>
<b>Communication</b>	Setting parameters for the communication interfaces of the NivuFlow Mobile
<b>User Indicator</b>	Setting the output fields (text, decimal places etc.)
<b>Battery (12V)</b>	Selection of the battery(ies) of the rechargeable battery block(s) used
<b>Quick Start</b>	Guided, quick parameterisation of simple measuring points
<b>Alarm</b>	Activate the alarm for sensor errors and set the upper and lower limits/thresholds at which an alarm is sent by e-mail via the NIVUS WebPortal.

Tab. 6 Menu overview

## Commissioning Examples

### 34 Measuring with Clamp-On Sensors

#### 34.1 General

Measurements with clamp-on sensors can be carried out very easily and with little effort. The sensors are attached to the pipe from the outside.

Before installing the sensor for clamp-on measurement, the measuring section must be prepared and the measurement place parameterised. The parameter settings of the measurement place include the following basic settings:

- Number and arrangement of paths
- Medium to be measured
- Pipe circumference or internal pipe diameter or outside pipe diameter
- Wall thickness
- Wall material
- If applicable, material of the inner lining

The transmitter calculates the position of the clamp-on sensors from these settings.

After parameterising the measurement place, the values for the sensor position can be read directly in the display of the operating module.



Observe the preparation measures of the measuring section in the "Mounting Instruction for Transit Time Sensors".

#### 34.2 Parameterisation of a diametral 1-path Measurement

To parameterise a 1-path measurement, it is necessary to enter all data of the measurement place. Familiarise yourself beforehand with the chapter "39 General Programming" starting on page 76. The parameterisation of the measurement place is described in Chapter "42.1 Menu Measurement Place" starting on page 88.

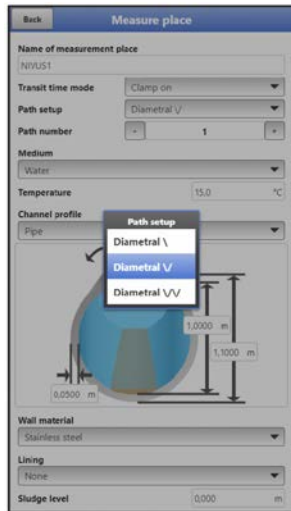
##### 34.2.1 Simple Parameterisation Procedure

###### Application Specifications:

- Stainless steel (steel)
- No inner lining
- No deposits in the pipe
- Path arrangement "Diametral \"
- 1 Path

###### Procedure:

1. Select the "Menu" field (top left).
2. Open the >Application< menu.
3. Open the >Measurement Place< menu.
4. Enter the name of the measurement place and confirm with "Enter".
5. Select >Clamp-On< as transit time mode.
6. Specify the path arrangement ("Diametral \") and the number of paths (1 Path).



**Fig. 34-1 Selection path arrangement**



**Notes on the Medium**

*If your medium to be measured is not in the displayed selection, select "Custom". Then another menu item opens in which you must enter, for example, the speed of sound of the medium.*

**Tip:**

*You can find lists of sound velocities on the Internet.*

7. Use the selection menu to select/enter the medium to be measured and the current temperature of the medium.
8. Set the channel profile to "Pipe".  
A pipe with four input fields is shown in the graphic area.
9. Enter the pipe data in the graphic area (example: DN1000). Two entries are sufficient for entering the pipe dimensions.  
In this case internal diameter and wall thickness.



**Fig. 34-2 Entering the pipe data**

After entering the inner diameter and wall thickness, the transmitter automatically adds the outer diameter and the pipe circumference. The same happens after

entering the circumference and wall thickness. The transmitter complements the remaining parameters.

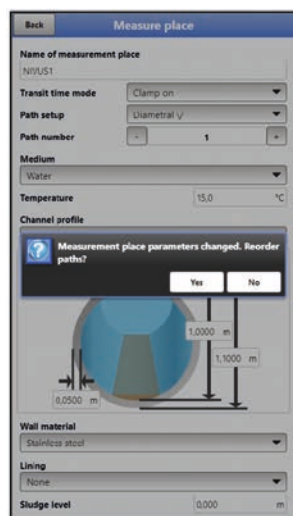
10. Select the wall material using the selection menu (stainless steel).

No further entries are necessary - the subsequent parameters (lining, sludge level etc.) remain at their factory settings.

Whenever a relevant parameter is changed in the >Measurement Place< or >v-Paths< menu, the arrangement of the paths must be reinitialised. This allows the path lengths and sensor positions to be recalculated.

➡ To adjust the **settings for the measurement paths**, exit the >Measurement Place< menu.

1. Press "Back" to switch to the >Application< menu.  
The following prompt appears on the display:

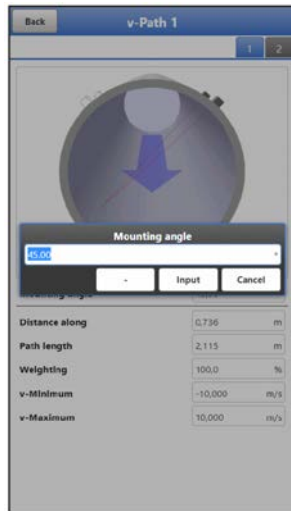


**Fig. 34-3** Accept changed measurement place parameters

2. Confirm changed measurement place parameters and the new arrangement of the paths. After confirming >Yes<, the message "Initialised!" is shown in the display.

➡ Procedure for **selecting the sensor** and **entering the mounting angle**

1. Select the >v-Paths< menu.
2. Select the sensor type used.
3. Specify the mounting angle (+45° or -45°) and confirm.



**Fig. 34-4 Entering the mounting angle (clamp-on)**

In the field >Lengthwise Distance< the mounting distance between the two sensors can be read in the display.

The distance is always the clearance between the two sensors.

All other parameters are read-only parameters or remain at the factory setting.

➡ After entering all necessary parameters for the measurement place, save the parameters:

1. Exit the menus with "Back" until >Save Parameters?< appears on the display.
2. Confirm with >Yes<.
 

The NivuFlow Mobile goes to the >Application< page. Via "Back" to the main menu. After pressing "Back" again and saving, the transmitter switches to the main display and operates with the newly entered parameters.

### 34.2.2 Extended Parameterisation Procedure

#### More Specifications:

- Pipe with inner lining
- Deposits in the pipe

#### For pipes with inner lining:

➡ Procedure:

1. Carry out steps 1 ("Menu" field, page 65) to 10 ("Wall Material"; page 67) inclusive as described in chapter "34.2.1 Simple Parameterisation Procedure".
2. Select the >Lining< Material.
 

The thickness of the lining is now shown in the graphic area. For the calculation with lining, the NivuFlow Mobile requires this additional value.
3. The thickness of the lining is now specified in the graphic area.
4. If there are also deposits in the pipe, enter the corresponding value for >Sludge Level< and confirm.
 

The transmitter subtracts this sludge level from the total wetted hydraulic area when calculating the flow.
5. To save the entries, select "Back" and agree to the change/arrangement of the paths with >Yes<.



6. Menu >v-Paths<: Select sensor and enter mounting angle.  
Here you can read the >Distance Lengthwise< and the >Path Length< for mounting the clamp-on sensors.

### **35 Measuring with wetted Sensors**

The parameterisation for a measurement place with wetted sensors is essentially analogous to the parameterisation when using clamp-on sensors.

A distinction must be made when selecting the >Transit Time Mode<, the selection of the >Path Arrangement< offers more variants and when reading off the installation values, the >Distance Across< also appears.

## Main Screen

### 36 Functions of the Main Screen

#### Quick Access

In addition to displaying the values themselves, the main screen also allows for direct access to the most important setting parameters.

The quick access enables to directly jump to important individual menus without having to go through the (sub)menus of the parameterisation. It hence serves as quick and uncomplicated check of the individual sensors involved in the measurement.

Quick diagnosis, uncomplicated parameter adjustment and adjustment are possible by using the quick access. Direct queries for basic device data such as serial and article numbers as well as the firmware version of the transmitter and the connected sensors are also possible with just a few mouse clicks.

### 37 General Overview

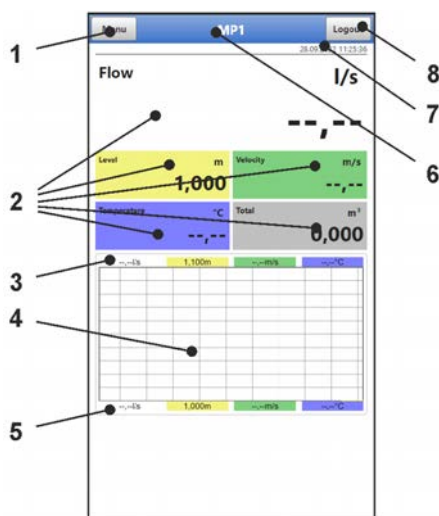
The following information is provided in the **top area** of the display:

- Menu and Logout Icons
- Measurement place name and service symbol, if applicable
- Date and Time

In operation mode the NivuFlow Mobile 600 displays the following important measured values in the **main area**:

- Flow
- Level
- Velocity
- Temperature
- Total

The **lower part** of the display shows a chart for flow, level, velocity, temperature and total.

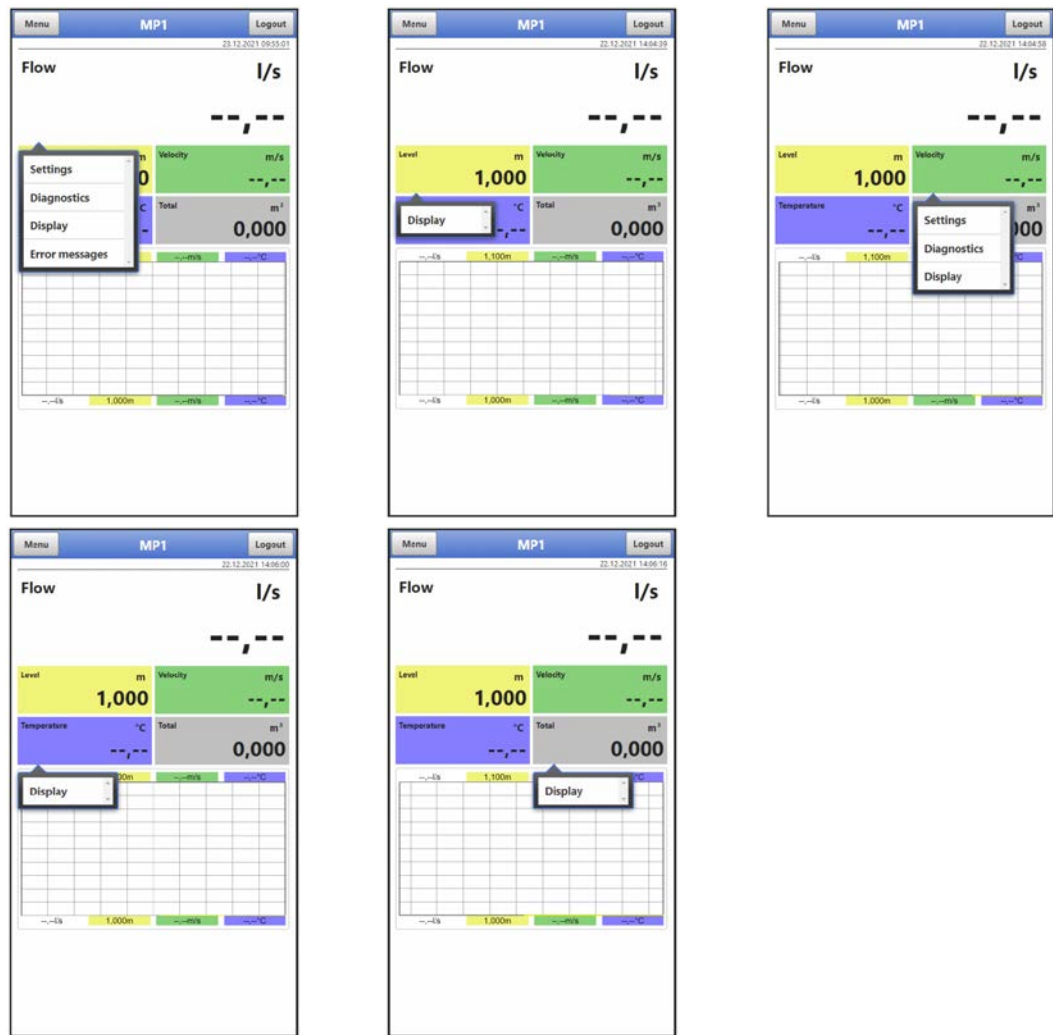


- 1 Icon to open the main menu
- 2 Output fields for the values flow, level, velocity, temperature and total
- 3 Upper scaling range for the diagram
- 4 Charts indicating flow, level, velocity, temperature and total

- 5 Lower scaling range for the diagram
- 6 Measurement place name and service symbol, if applicable
- 7 Date and Time
- 8 Icon for logging out the operating and display module

**Fig. 37-1 Main screen overview**

A pop-up menu with the most important settings and information can be accessed directly via the fields of the main display with a mouse click (left button). A further mouse click on the selection opens the respective pages and offers the possibility to parameterise or view current states.



**Fig. 37-2 Pop-up menus**



### Save Parameters

*After changing system-specific parameters, the changes must be saved for them to take effect.*

## 38 Display Fields

### 38.1 Display Field Flow

When clicking on the pop-up menus, the transmitter opens the following pages:

- Settings: >Application< / >Measurement Place<; see Chapter "42.1 Menu Measurement Place" starting on page 88
- Diagnostics: >Application< / >Diagnostics<; see Chapter "Diagnostics" starting on page 139
- Display: >Display<; see Chapter "46 Parameter Menu Display" starting on page 127
- Error Messages: >System< / >Error Messages< / >Active Error Messages<; see Chapter "44.4 Menu Error Messages" starting on page 114

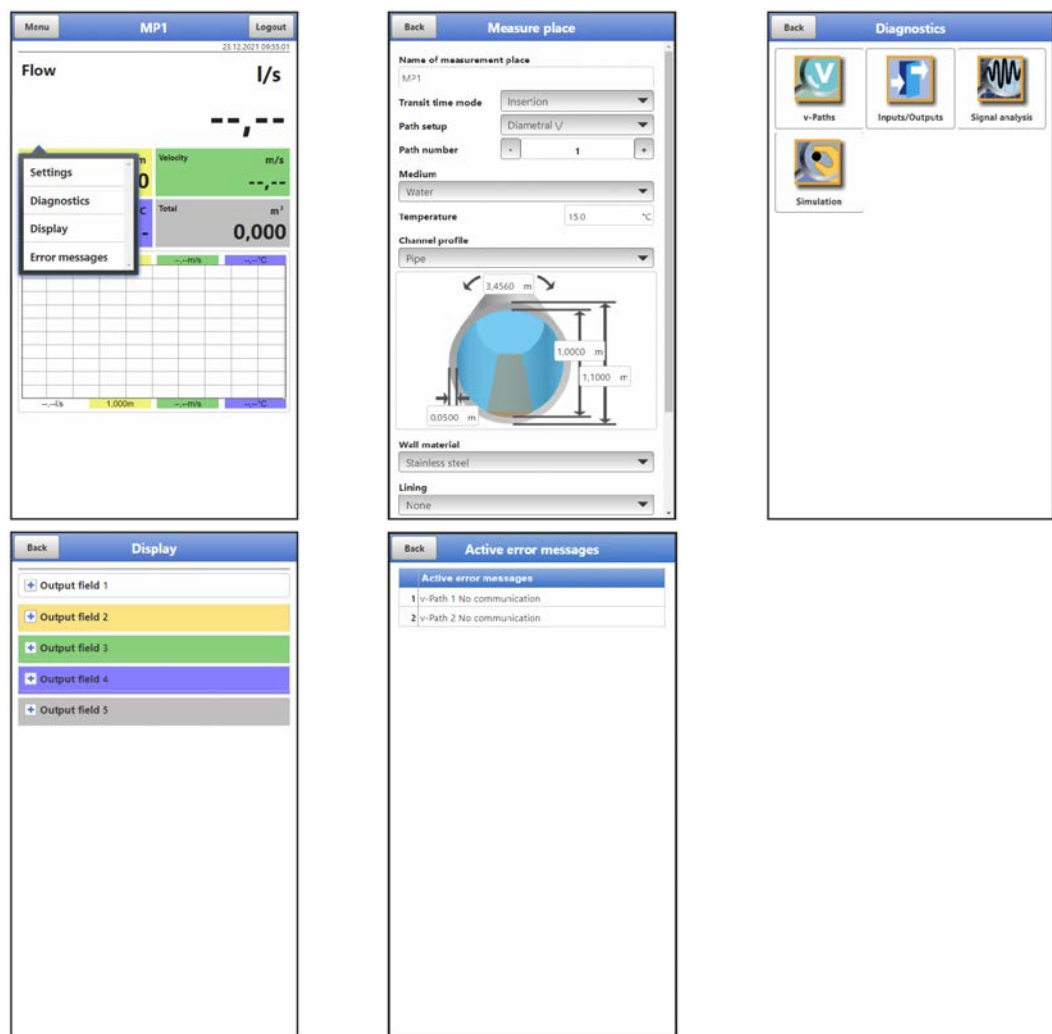


Fig. 38-1 Opened display fields with flow

### 38.2 Level Display Field

When clicking on the pop-up menu, the transmitter opens the following page:

- Display: >Display<; see Chapter "46 Parameter Menu Display" starting on page 127

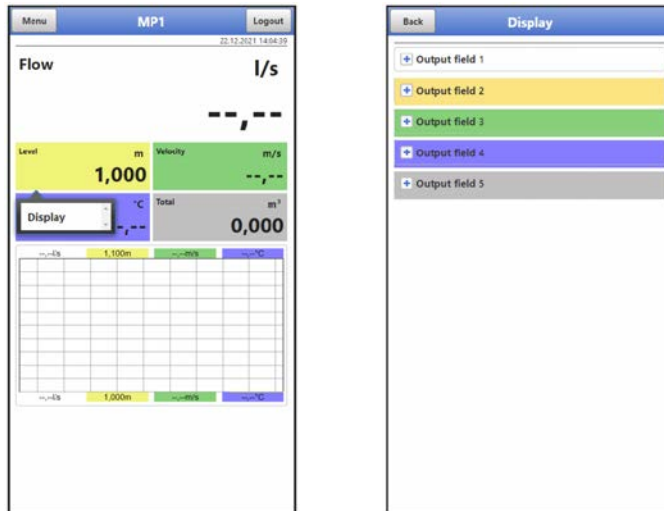


Fig. 38-2 Opened display fields with level

### 38.3 Display Field Velocity

When clicking on the pop-up menus, the transmitter opens the following pages:

- Settings: >Application< / >v-Paths<; see Chapter "42.2 Menu v-Paths" starting on page 93
- Diagnostics: >Application< / >Diagnostics< / >v-Paths<; see Chapter "51 Menu Diagnostics v-Paths" starting on page 140
- Display: >Display<; see Chapter "46 Parameter Menu Display" starting on page 127



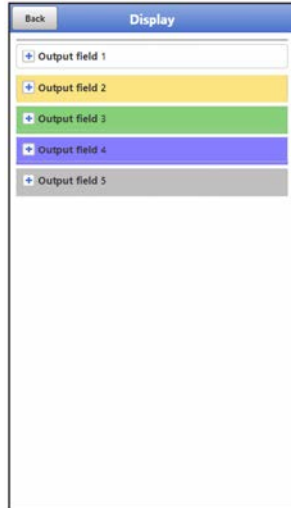


Fig. 38-3 Opened display fields with velocity

### 38.4 Temperature Display Field

When clicking on the pop-up menu, the transmitter opens the following page:

- Display: >Display<;  
see Chapter "46 Parameter Menu Display" starting on page 127

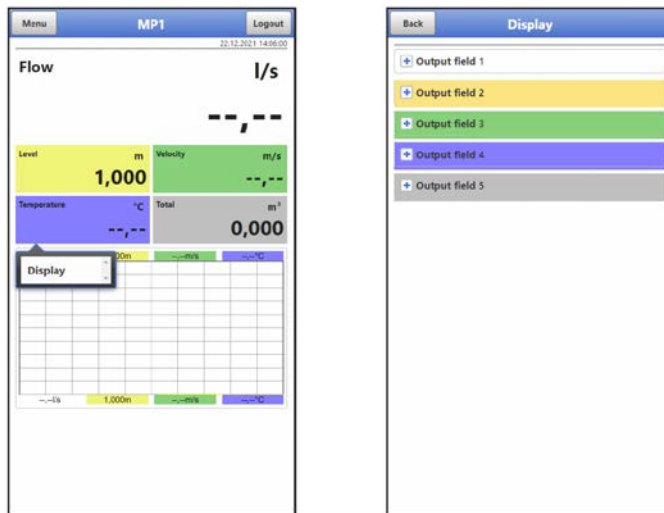


Fig. 38-4 Opened display fields with signal temperature

### 38.5 Display Field Total

When clicking on the pop-up menu, the transmitter opens the following page:

- Display: >Display<;  
see Chapter "46 Parameter Menu Display" starting on page 127

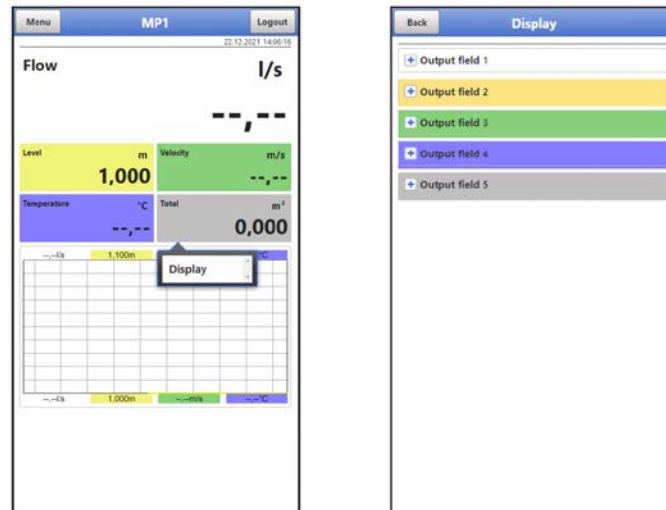


Fig. 38-5 Opened display fields with total

## Setting Parameters

### 39 General Programming

In principle, changed parameters do not become effective before they have been saved. When exiting all menus via the "Back" field, the transmitter checks whether parameters have been changed. Finally, you are asked whether the parameters should be saved.

- >Yes<: the changed parameter setting is accepted and saved.
- >No<: the changes to the parameters are discarded and the device exits the menus.
- >Cancel<: You exit the query. The parameters remain changed, but are not yet effective and not saved.



---

**Tip for repeated measurement of the same measurement places**

*If measuring points are not only measured once but repeatedly, it is recommended to save the parameterisation of the measuring point and, if necessary, also the measurement data on a USB stick. During the next measurement at the measuring point in question, these can then be quickly reloaded onto the transmitter and there is no need for new parameterisation.*

*See Chapter "43.3 Menu Data Memory" starting on page 106.*

---

#### 39.1 Save Parameters

After entering all necessary (measurement place) parameters, these must be saved to become effective.

➡ Procedure (2-stage):

1. Select "Back": a window with the message >Measurement Place parameters changed. Rearrange paths?< is shown. Confirm with >Yes< \*1.  
The message "Initialised!" indicates the successful initialisation of the parameters.

\*1 >Yes< initialises the changed parameters (in the current menu); >No< aborts the initialisation process, the last changed values remain active and the initialisation process (in the current menu) can be continued; a real abort of the initialisation process must be done with the next work step via >Save Parameters?< - >No<.

2. Select "Back" 2 times: a window opens with the message >Save Parameters?<. Confirm with >Yes< \*2.  
The message "Successful!" indicates the completed saving of the parameters.

\*2 >Yes< saves the new parameters; >No< cancels the saving process and the last saved parameters are active again; >Cancel< cancels the saving process, the last changed parameters remain active and the initialisation process can be continued.

#### 39.2 Change WLAN Password

The WLAN password is set **per default** to an individually determined identifier for the device. This is attached as a sticker on the top of the transmitter (inside the enclosure).

This factory-assigned password can be changed as described below. The new password must have between 8 and 32 characters.

➡ Procedure:

1. Open the main menu via "Menu".
2. Open the >Communication< menu.
3. Open the >WLAN< menu.
4. Select the >Password< field.



5. Enter the new password and confirm.

Up to four users can access the transmitter and its parameterisation simultaneously via the WLAN access. Simultaneous access is not indicated or logged.

If changes in the parameterisation are necessary, make sure that this is done in consultation and that there is no simultaneous access. The last saved parameter is always valid.



---

**Keep your password safe**

*Only give the password to authorised persons.*

*If you write down the password, keep it in a safe place.*

---

### 39.3 Change the device SSID

The SSID is set **per default** to the serial number of the unit. This is written on the nameplate on the side of the enclosure.

This factory-assigned SSID can be changed as described below. The new SSID must have between 8 and 32 characters.

➤ Procedure:

1. Open the main menu via "Menu".
2. Open the >Communication< menu.
3. Open the >WLAN< menu.
4. Select the >SSID< field.
5. Enter the new name and confirm.

### 39.4 Loss of the Password

Each NivuFlow Mobile is delivered with a PUK ("Personal Unblocking Key" or also Super PIN). This allows the unit to be reactivated if the password is forgotten and a new password can be assigned.

This PUK is identical to the default WLAN password which is attached as a sticker on the top of the transmitter (inside the enclosure).

➤ Procedure:

1. Open the cover.
2. Loosen the hexagon socket screws on the cover above the battery compartment and remove the cover.
3. Take out the rechargeable battery blocks.
4. Hold the magnet against the Reed contact and at the same time insert a rechargeable battery block.  
The magnet must be held against the Reed contact for at least 15 seconds until the LED flashes red several times. The NivuFlow Mobile will be "woken up".
5. The NFM appears in the WLAN list with the default SSID (identical to the serial number of the respective device according to the nameplate).
6. Enter the default PUK as password.
7. Enter new password and possibly also the SSID according to Chapters "39.2 Change WLAN Password" and "39.3 Change the device SSID".
8. To adopt the new password/SSID, reinitialise the unit by removing and re-inserting the rechargeable battery blocks.
9. Activate the NFM within five minutes, otherwise the password changes will not be accepted and the unit will continue to report under the default identifier and will only respond to the factory-assigned password.

10. If necessary, insert a second rechargeable battery block.
11. Replace the cover over the battery compartment with the hexagon socket screws and close the cover.

### 39.5 Automatic Data Transmission to USB Stick

Normally, data stored on the NivuFlow Mobile is transmitted to the display and control module via WLAN.

➡ See Chapter "43.3 Menu Data Memory".

If, in exceptional cases, this is not possible because, for example, a WLAN connection cannot be established, the display and operating module is not functioning correctly or its battery is empty, it is possible to automatically read out the data memory with the measurement data via an inserted USB stick.



---

***Use of the USB interface is only permitted outside the Ex area.***

---

🔄 Procedure:

1. Open the enclosure and unscrew the screw cap over the USB slot.
2. Insert the USB stick.
3. "Wake up" the NivuFlow Mobile by using the magnet.  
If no WLAN connection is established within 5 minutes, the transmitter automatically transfers the complete contents of the measurement data memory to the inserted USB stick. The status LED on the transmitter flashes green during this time.
4. After the status LED has stopped flashing, the data transfer is complete and the USB stick can be removed.

## 40 Procedure for Setting Parameters via Quick Start

This menu enables quick parameterisation of simple measurement places using the factory settings for various parameters.

➡ The >Quick Start< menu is described in detail in the Chapters "41.2.7 Menu – Quick Start" and "48 Parameter Menu Quick Start".

🔄 Procedure:

1. Connect sensors according to Chap. "24 Installation of Sensors" and "26 Connection of Sensors".
2. Open the main menu.
3. Select the menu >Quick Start<.  
The query "Create new Measurement Place?" is made.



**Fig. 40-1 Quick start with query**

4. Either select >No<: the >Country Settings< page of the >Quick Start< menu opens. Or select >Yes<: the security question "Sure? Old parameters and archive data are deleted!" is asked. If confirmed here with >Yes<, the data transmitter deletes the old parameters and archive data. However, if you confirm with >No<, nothing is deleted and the >Country Settings< page opens.



***Previously connected sensors are detected***

*If the transmitter detects already connected NIVUS sensors during the sensor scan, their data is taken over directly.*



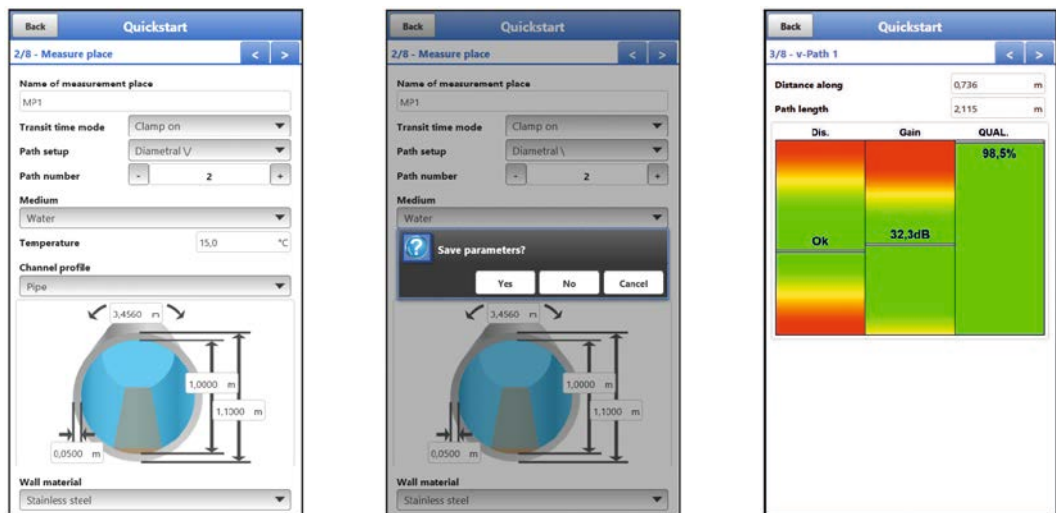
**Fig. 40-2 Security query "Deleting Parameters and Data"**

5. On the >Country Settings< page, set the language, the date format, the different units, the system time and the memory mode (operating mode and storage cycle).



**Fig. 40-3 Menu >Country Settings<**

6. Continue with the arrow keys to go the next page >Measurement Place<.
7. Parameterise the measurement place: Define measurement place name, transit time mode, path arrangement, number of paths, medium, temperature (of the medium), canal profile with dimensions, wall material and possibly lining.



**Fig. 40-4 Menu >Measurement Place< / >Country Settings< / >v-Path 1<**

8. Use the arrow keys to go the next page.  
The query for saving the parameters is made.  
If >Yes<, it is saved and the next page >v-Path 1< is opened.  
If >No<, nothing is saved and the next page >v-Path 1< is opened.  
With >Cancel< the current page >Measurement Place< remains open and the parameterisation on this page can be continued.
9. The page >v-Path 1< (if there are two paths there is also a page >v-Path 2<) is a read-only page. Here you can read the installation data for the velocity sensors and the strength of the signal.
10. The analogue and digital inputs used are parameterised on the following pages, depending on their use.
11. On the last page, parameterise the communication via the mobile phone network accordingly.  
**Make sure** that the unit automatically searches for the GPS coordinates (latitude/longitude) and that these are then entered in the menu. This may well take a few minutes.

➡ See also Chap. "45 Parameter Menu Communication".



**Fig. 40-5** Menu >Communication<

12. Return to the main menu with "Back": The query for saving the parameters is made. If >Yes< is selected, saving is confirmed with the message "Successful!". Press >OK< to open the main menu. If >No< is selected, nothing is saved and the main menu is opened. With >Cancel< the current page >Communication< remains open and the parameterisation on this page can be continued.

OR

Complete the quick start parameterisation by clicking on the small arrow pointing upwards at the top right of the menu:



The prompt for saving the parameters appears.

If >Yes< is selected, saving is confirmed with the message "Successful!". Press >OK< to open the main menu.

If >No< is selected, nothing is saved and the main menu is opened.

With >Cancel< the current page >Communication< remains open and the parameterisation on this page can be continued.

13. Use "Back" (again) to go back to the main screen.

## 41 Parameter Functions

### 41.1 Main Menu

The NivuFlow Mobile 600 is parameterised via the total of eight settings menus. The individual menus are explained in greater detail starting with Chapter "42 Parameter Menu Application". In the main menu there are eight icons with the functions described below.



Fig. 41-1 Overview Main Menu

### 41.2 Functions of the first Menu Level

#### 41.2.1 Menu - Application

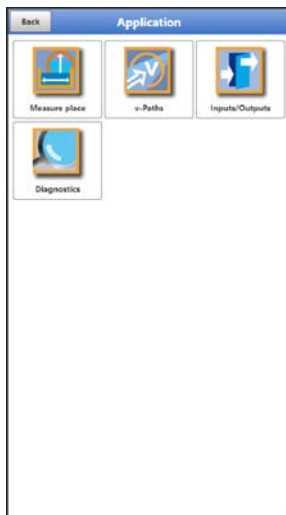


Fig. 41-2 Menu Application

This menu is the most comprehensive and important within the parameterisation of the NivuFlow Mobile. The application menu includes four submenus.

The shape and dimensions of the measurement place are programmed here. The flow velocity sensors used are defined and the data for their mounting position is programmed.

Moreover, the required analogue and digital inputs and outputs can be defined here:

- Functions
- Measurement Ranges
- Measurement Spans
- Limit Values

This menu provides diagnostic options for:

- Transducers
- Inputs and outputs
- Overall system
- Signal analysis
- Simulation

Possible entries or changes within this menu:

- Constant, fixed sludge levels
- Low-flow suppression
- Damping of signal evaluation/output
- Stability of signal evaluation/output

## 41.2.2 Menu – Data



---

**Fig. 41-3 Menu Data**

The data menu includes all internally saved measurement values.

The following functions are available:

- Graphic representation of the measurement values
- Listing of the last 100 24h day totals
- Communication and transmission options of internal files
- Transfer of set parameters from and to USB stick
- Setting and deleting options of the internal data memory

### 41.2.3 Menu – System



**Fig. 41-4 Menu System**

This menu contains information on the transmitter:

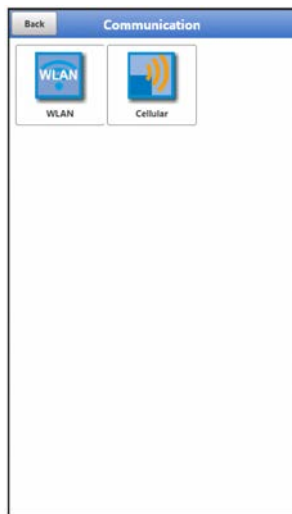
- Firmware version
- Article No
- Serial number
- Information on battery voltage and credits/licences

In addition, the following settings are possible:

- Language
- Units
- Set/correct date and time (system time, time zone, time server)
- Read active messages
- Delete error memory
- Configure Storage Cycle
- Shut Down Device (Powerdown)
- Execute parameter reset
- Unlock licenced functions
- Carry out firmware updates



## 41.2.4 Menu - Communication



---

**Fig. 41-5 Menu Communication**

This menu contains the setting options for communication with other systems:

- WLAN
- Mobile

## 41.2.5 Menu - Display



---

**Fig. 41-6 Menu Display**

This menu defines the five display fields of the main display.

### 41.2.6 Menu - Battery (12V)



**Fig. 41-7 Menu Battery (12V)**

In the Battery menu, the battery types used and their number are selected.



#### **Correct display of the capacity indicator**

The capacity display in the >System< / >Information< menu only works reliably if fully charged battery blocks are used and the battery type and number of rechargeable battery blocks used are entered here.

At voltages <11.5 V (capacity 20 %), voltage dips and undervoltage shutdown may occur during data transmission.

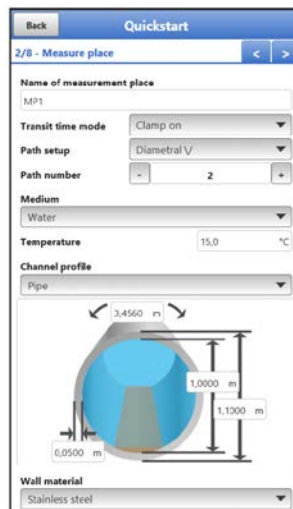
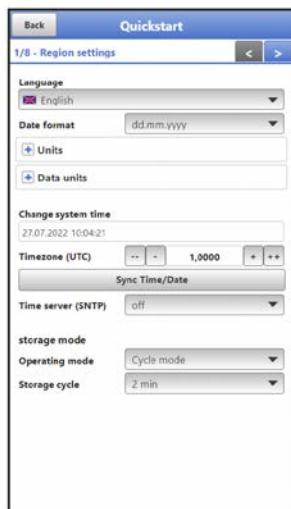
NIVUS recommends replacing the rechargeable battery blocks at the latest when the remaining capacity is 20 %.

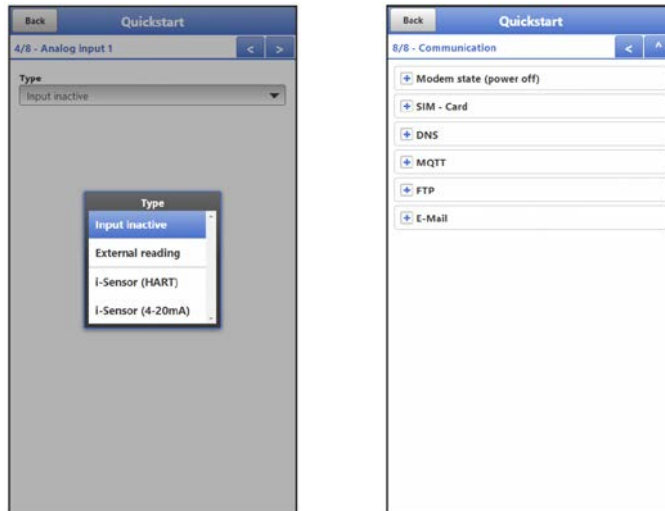
**Tip:**

By using two rechargeable batteries, storing and using them at non-critical temperatures (such as room temperature) and storing them dust-free, clean and dry, their capacity can be maintained for longer.

This means that even remote data transmission can often still function well at values below the threshold of 20 %.

### 41.2.7 Menu – Quick Start





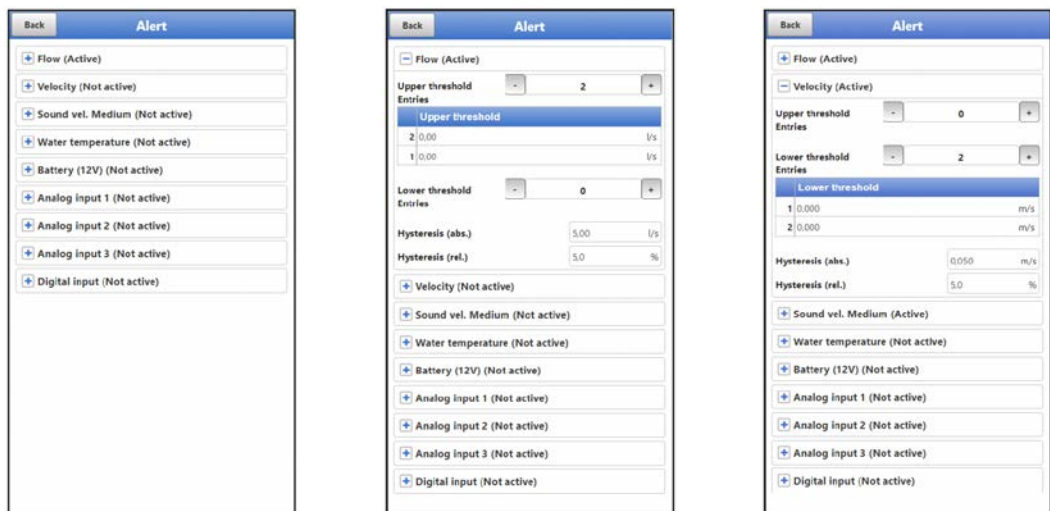
**Fig. 41-8 Menu Quick Start**

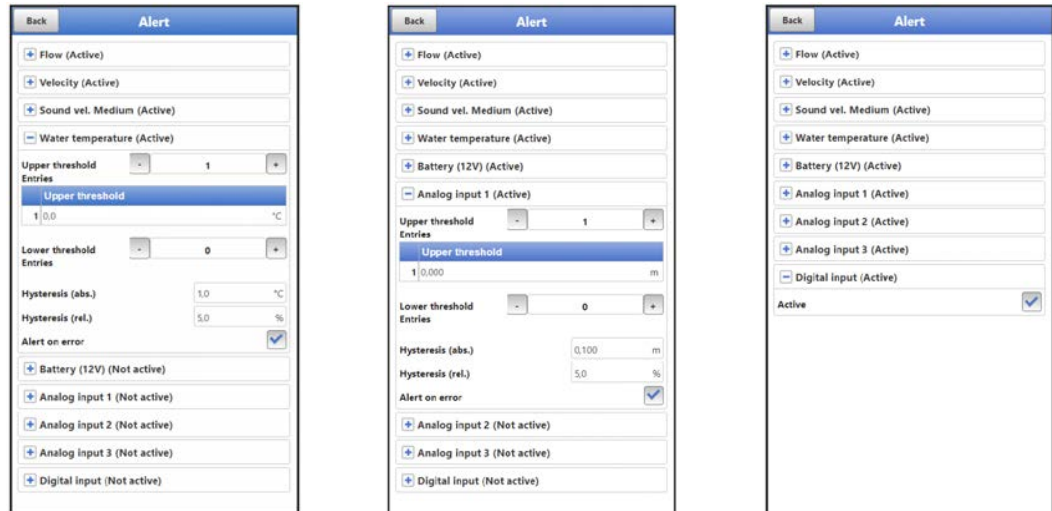
This menu enables quick parameterisation of simple measurement places using the factory settings for various parameters.

Depending on the number of connected v-sensors/paths and use of the analogue and digital inputs, there are up to nine pages in the >Quick Start< menu:

- Page 1 >Country Settings<
- Page 2 >Measurement Place<
- Page 3 >v-Path 1<
- Page 4 >v-Path 2<
- Page 5 >Analogue Input 1<
- Page 6 >Analogue Input 2<
- Page 7 >Analogue Input 3<
- Page 8 >Digital Input 1<
- Page 9 >Communication<

## 41.2.8 Menu – Alarm

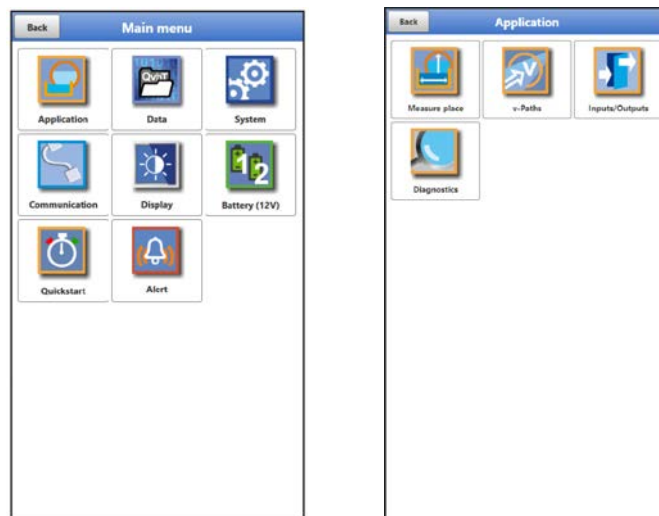




**Fig. 41-9 Menu Alarm**

The Alarm menu consists of up to nine sub-items, depending on the parameterisation of the transmitter: >Flow<, >Velocity<, >Sound Velocity Medium<, >Water Temperature<, >Battery (12V)<, >Analogue Input 1<, >Analogue Input 2<, >Analogue Input 3< and >Digital Input<. The upper and lower limit values/thresholds and error messages can be set here. When these are reached or occur, the transmitter sends an alarm e-mail to the pre-set e-mail address.

## 42 Parameter Menu Application



**Fig. 42-1 Menu Application**

The general parameterisation is described below.

The parameterisation for the measurement with clamp-on and wetted sensors is different. The submenus >Measurement Place< and >v-Paths< must be parameterised differently depending on the transit time mode.

Therefore, these two submenus are explained separately.

### 42.1 Menu Measurement Place

The submenu >Measurement Place< is one of the most important basic menus in the parameterisation.

The parameter settings of the measurement place include the following basic settings:

- Measurement Place Name

- Transit Time Mode
- Arrangement/Number of Paths
- Measurement Medium and Medium Temperature
- Type and dimensions of the channel profile
- Pipe Material (incl. lining)
- Possibly fixed settings for sediments (sludge level)
- Low-flow suppression
- System times or damping and stability of the measurement

## 42.1.1 Measurement Place Name

The measurement place name can be changed here.

**Default setting:** MP1

When initialising the measurement place name, the default name is automatically deleted after the first letter or number is selected.

- ➡ Write the desired measurement place name in the text field and confirm with "Enter". The measurement place name is transferred to the main menu and displayed there.

## 42.1.2 Transit Time Mode

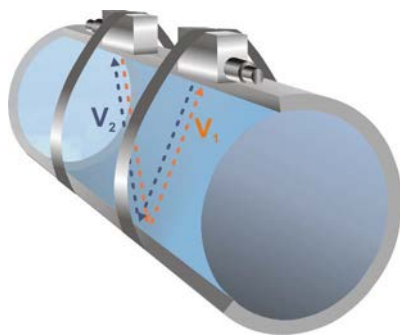
In >Transit Time Mode< the type of measurement method is set. The choices are:

- Clamp-On (sensors attached on the outside)
- Wetted (use of built-in sensors; in direct contact with the medium)

Depending on the selection, the view of the following menus changes. In this case, both variants are described at the appropriate place in the operating instructions.

### Path Arrangement in Transit Time Mode >Clamp-On<

The clamp-on measurement is diametrical. The most common variants are the measurement in diagonal direction ("Diametral \") or the measurement as V-Echo ("Diametral V") (Fig. 42-2).



---

**Fig. 42-2 1-Path measurement, path arrangement: "Diametral V"**

The choices are:

- Diametral \
- Diametral V
- Diametral VV

### Path Arrangement in Transit Time Mode >Wetted<

Measurement with wetted sensors can be diametrical or chordal.

The choices are:

- Diametral \
- Diametral V
- Diametral VV
- Chordal \
- Chordal V
- Chordal VV
- Chordal X

#### 42.1.3 Number of Paths

The number of paths is generally limited to two in the NivuFlow Mobile.

The number of paths is set by using the "+" and "-" fields, the number is displayed in the text field in between.

#### 42.1.4 Medium

"Water" and "Custom" are stored for selection in the transmitter. "Water" is assigned fixed data; for "Custom", information such as sound velocity, start, entries, damping and density of the medium must be entered during parameterisation.



Fig. 42-3 Selection measurement medium



#### **Selection measurement medium**

*If your medium to be measured is not in the selection, select "Custom". In this case, another menu item opens in which you must enter, for example, the speed of sound of the medium.*

**Tip:**

*You can find lists of these sound velocities on the Internet.*

## 42.1.5 (Medium) Temperature

The temperature of the medium is required to calculate the sensor distance (mounting) and must be entered as accurately as possible.

## 42.1.6 Channel Profiles

With the NivuFlow Mobile with clamp-on measurement, you can choose between "Pipe" and "Rectangle". The "Pipe" is circular, not elliptical.

The selected profile is displayed graphically in the preview field. However, the entered dimensions (in proportion) do not match the graphical representation. There is **no visual control**.



Select Profile.

After selecting the profile the dimension values are entered.

The unit of measurement used is factory set in metres [m], but can be changed in the menu >System< / >Country Settings< / >Units< / >Level< (Fig. 42-4).



**Fig. 42-4** Setting the measurement units

### Entering the Canal Dimensions

For **pipes**, two entries are sufficient for entering the pipe dimensions:

- Pipe circumference or inner diameter or outer diameter
- Wall thickness

After entering the inner diameter and wall thickness, the transmitter automatically adds the outer diameter and the pipe circumference. The same happens when circumference and wall thickness are entered. The transmitter complements the remaining parameters.

For **pipes with inner lining**, the thickness of the lining material must also be specified. The transmitter takes this material thickness into account and calculates the correct inner diameter.

For the **rectangular profile**, width, height and wall thickness are required. If there is a lining in the canal, the thickness of the lining must be specified too.

### 42.1.7 Wall material

Different pipe materials also have different properties in the speed of sound.

The most common pipe materials are stored in the selection menu.

Based on this selection and the specification of the measurement medium, the transmitter calculates the sound propagation time for the measurement.



#### **Selection Wall Material**

*If the material of the pipe at the measuring point is not in the selection, select "Custom". In this case, another menu item opens in which you must enter, for example, the speed of sound of the pipe material.*

**Tip:**

*Contact the pipe manufacturer for the required values.*

### 42.1.8 Lining

In practice, it occasionally happens that pipelines have an inner lining.

The most common lining materials are stored in the selection menu.

Based on this selection and the specification of the measurement medium, the transmitter calculates the sound propagation time for the measurement.



#### **Selection Lining Material**

*If your existing material is not listed, select "Custom" and contact the piping manufacturer for the required values.*

### 42.1.9 Sludge Level

In horizontal pipelines, depending on the measured medium and the flow velocity, deposits (sediments) may occur on the pipe bottom.

In this parameter, a fixed sediment height (deposition) in the pipe can be entered as >Sludge Level<. The entered sludge level is calculated as the "non-moving, bottom lying partial area of the channel with a horizontal surface". This height is subtracted from the total wetted hydraulic area before the flow calculation.

### 42.1.10 3D Preview

If the 3D preview is selected, the parameterised measurement place with the respective sensors can be displayed.

### 42.1.11 Low-flow suppression

This parameter is used to suppress the slightest movements or apparent quantities. The main field of application is the measurement of discharge rates in structures that are permanently dammed.

- ☞ Check >Active< and enter the desired value for >Q suppressed< or >v suppressed<.

Low-flow suppression prevents the detection of the slightest changes in velocity. These changes can cause large apparent fluctuations in the measured volume over a longer period of time.

Flow velocities that are smaller than this parameterised value are "suppressed" and therefore no flow rate is detected. The transmitter does not store a value.

- **>Q suppressed<**  
Specify the flow value as positive value.  
Negative values are not possible. The entered value is interpreted as an absolute value and has both a positive and negative effect. If the current, calculated measurement



values are smaller than this entered value, the system automatically sets the measurement values to "0".

- **>v suppressed<**  
Low-flow volumes can be suppressed here for applications in large profiles and with high filling levels. The slightest changes in velocity can cause large apparent changes in volume over a longer period of time, which cannot be suppressed using the value >Q suppressed<. If the flow velocities are lower than this parameterised value, the system automatically sets the measurement values to "0".  
This also makes the calculated volume "0".  
Only a positive value can be specified. The entered value is interpreted as an absolute value and is effective for both positive and negative velocities.

## 42.1.12 System Times

For the system times, either "Minimum Measurement Duration" and "Maximum Measurement Duration" or "Damping" and "Stability" can be set depending on the set operating mode.

**For "Cycle Mode", "Event Mode" and "Event Continuous Mode":**

- **Minimum Measurement Duration**  
This menu item allows you to set the minimum required measuring time in seconds. The entry is made in steps of 1 second each  
**Default setting:** 5 s
- **Maximum Measurement Duration**  
This menu item allows you to set the maximum required measuring time in seconds. The entry is made in steps of 1 second each  
**Default setting:** 10 s

**For "Continuous mode":**

- **Damping**  
The damping refers to all level and flow velocity values that are available as input values. Individual values cannot be selected and damped differently.  
All measurement values are stored over the specified time range and a moving average is calculated for each individual measurement value. This average value is used for further calculation of the flow rate.  
The entry is made in steps of 1 second each.  
**Default setting:** 30 s
- **Stability**  
The stability is the time span within which the transmitter bridges the values without correct measurement.  
The transmitter operates during this period with the last valid measured value. If the specified time span is exceeded without a correct value being recorded, the transmitter goes to the measured value "0", taking into account the set damping.  
The entry is made in steps of 1 second each.  
**Default setting:** 30 s

## 42.2 Menu v-Paths

Information in this menu item refers to the channel defined in the >Measurement Place< menu.

In this menu, you can also make some entries for the calculation of the sensor positioning. After the input, the NivuFlow Mobile shows the mounting distances of the sensors in this menu.

In the menu >v-Paths< the tabs with the v-paths 1 and 2 are displayed in the top right corner. The basic structure is the same for all of them, but the sensors and values displayed can vary depending on the application.

The transmitter recognises the connected NIVUS sensors and automatically adopts their serial and article numbers with the associated data.

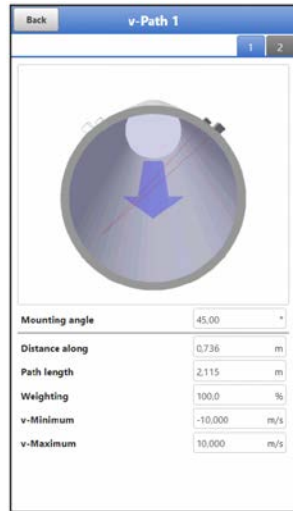


Fig. 42-5 v-Path menu

## 42.2.1 Mounting Position of Sensors

### Mounting Angle, Distances and Path Length



#### **Note on the Mounting Angle**

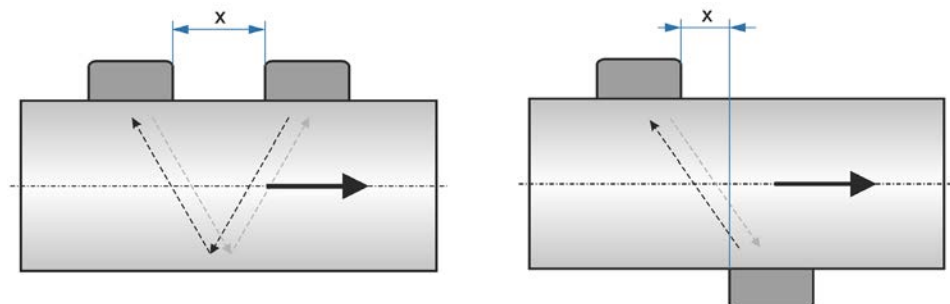
*In horizontal pipelines, the top and bottom of the pipe should be avoided as installation locations (risk of sludge, air bubbles).*

*NIVUS recommend a mounting angle of 45°.*

This is where you set the angle at which the sensors are clamped onto the pipe or installed. The mounting angle must be specified for each path separately.

#### ➤ Procedure for Sensor Parameterisation:

1. Enter the >Mounting Angle<.  
In combination with the previously entered parameters for the measurement place, the transmitter calculates the >Distance Lengthwise< or >Distance Crosswise< and the >Path Length<. These values are only display values and can be used for fastening the sensors.  
The parameter >Distance Lengthwise< is the clearance dimension (x) between the two sensors.



2. If required, specify the >Weighting<. See the following Chap. "42.2.2 Weighting".
3. Repeat the previous steps for the second path in the same way as for path 1.

## 42.2.2 Weighting

When using multiple paths, the valence of each individual path to the measurement result of the average total velocity must be defined. The entry is made in the >Weighting< field and is specified in %.

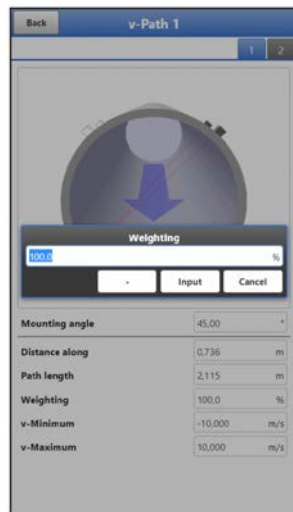
**Default setting:** 100 %



### **Expert knowledge required**

*The value of the weighting depends on the application and the sensor position.*

*Such applications require extensive knowledge of fluid mechanics and require the use of NIVUS commissioning personnel or an authorised specialist company.*



**Fig. 42-6 Weighting v-Paths**

## 42.2.3 v-Minimum and v-Maximum

The settings of >v-Minimum< and >v-Maximum< set the limit values for the velocity measurement. Individual higher and lower velocities are ignored by the transmitter and not displayed. If deviations are measured permanently, the transmitter displays them as "0" and only displays the next realistic measurement results again.

**Default setting:**

- v-Minimum: -10 m/s
- v-Maximum: 10 m/s

A classic application is the prevention of the evaluation of negative flow velocities (backflow). In this case, the maximum value of the negative flow velocity is simply set to "0".



### **Specifications show upper limit**

*An increase of the possible flow velocity evaluation beyond the technical limits given in the Technical Description Transit Time Sensors Chapter "Specifications" is not possible and the device adopts the respective possible limit values.*



Fig. 42-7 Limiting the Velocity Evaluation

### 42.3 Menu Inputs and Outputs (analogue and digital)

In this menu, the functions of the analogue and digital inputs and outputs are defined. Further parameter settings such as measurement and output spans, offsets, limit values, error reactions etc. are also possible in this menu.

➡ Open menu >Inputs/Outputs Inputs< via >Main Menu< / >Application<.

The Inputs/Outputs menu is divided into four sections:

- Analogue Inputs
- Analogue Outputs
- Digital Inputs
- Digital Outputs

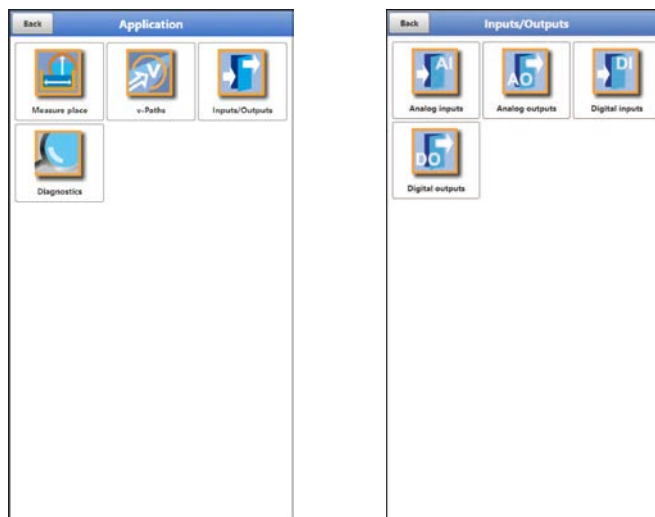


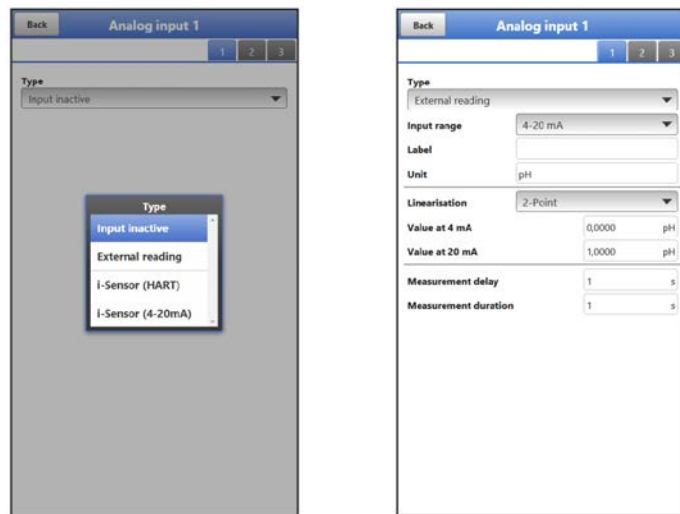
Fig. 42-8 Menu Inputs/Outputs

#### 42.3.1 Analogue Inputs

The transmitter is equipped with three analogue inputs. These are shown in the top right corner of the display and can be selected individually. The selected analogue input is highlighted in colour and the name is shown in clear text in the title bar.

**Default setting:** Input inactive

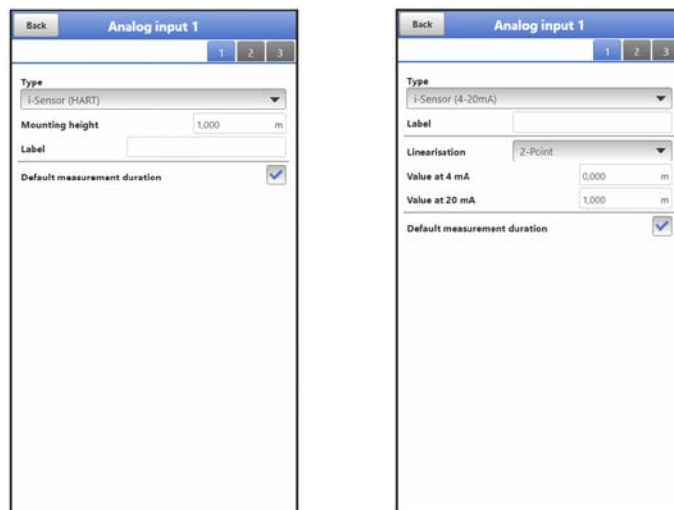
Alternatively, the transmitter can be used as an additional data logger for measured values from external systems or to supply analogue sensors. The actual task as a flow transmitter is not affected by this.



**Fig. 42-9 Analogue input inactive / external measurement value**

The following values must be selected/entered in **>External Measurement Value<**.

- Selection/input options:  
 Input range: **>0-20 mA<** or **>4-20 mA<**  
 Designation: manual input  
 Unit: manual input  
 Linearisation: **>2-Point<** or **>Table<**  
 For **>2-Point<** linearisation: manual input of the values for 4 or 20 mA  
 For **>Table<** linearisation: enter the number of **>Entries<** manually, then select **>Table<**, fill in and confirm  
 Measurement delay: manual entry of values  
 Measurement duration: manual entry of values



**Fig. 42-10 Analogue input i-Sensor (HART) / i-Sensor (4-20 mA)**

The following values must be selected/entered in **>i-Sensor (HART)<** (only available for analogue input 1).

- Selection/input options:  
 Mounting height: manual input  
 Designation: manual input  
 Standard measurement duration: tick if the box is unchecked, manual entry of values for measurement delay and measurement duration

The following values must be selected/entered in **>i-Sensor (4-20 mA)<**.

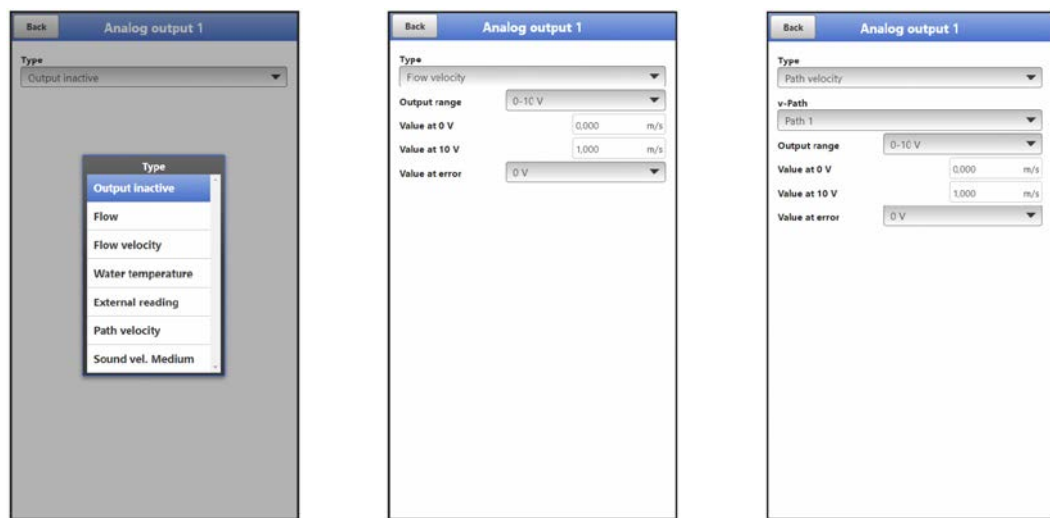
- Selection/input options:  
Designation: manual input  
Linearisation: >2-Point< or >Table<  
For >2-Point< linearisation: manual input of the values for 4 or 20 mA  
For >Table< linearisation: manual entry of the number of >Entries<, then select >Table<, fill in and confirm  
Standard measurement duration: check box, if box is not checked manual entry of values for measurement delay and measurement duration

### 42.3.2 Analogue Outputs

The transmitter is equipped with an analogue output 0-10 V.

**Default setting:** Output inactive

The following different functions can be assigned to the analogue output.



**Fig. 42-11 Activation analogue output**

- **Flow**  
The flow rate of the application (calculated from average flow velocity and wetted cross-section) is output at the selected analogue output.
  - Selection/input options:  
Output range: >0-5 V< or >0-10 V<  
Value at 0 V: manual input  
Value at 5/10 V: manual input  
Value at error: >0 V< or >Hold Value< or >10 V<
- **Flow Velocity**  
The average calculated flow velocity used to calculate the current flow rate is available at the selected analogue output.
  - Selection/input options:  
Output range: >0-5 V< or >0-10 V<  
Value at 0 V: manual input  
Value at 5/10 V: manual input  
Value at error: >0 V< or >Hold Value< or >10 V<
- **Water Temperature**  
The medium temperature determined by the flow velocity sensor can be output at the selected analogue output.
  - Selection/input options:  
Output range: >0-5 V< or >0-10 V<  
Value at 0 V: manual input

Value at 5/10 V: manual input  
 Value at error: >0 V< or >Hold Value< or >10 V<

- **External Reading**

Measurement values applied to the analogue input and linearised, if applicable, can be output here again.

- Selection/input options:  
 Analogue input: >Input 1< or >Input 2< or >Input 3<  
 Output range: >0-5 V< or >0-10 V<  
 Value at 5/10 V: manual input  
 Value at error: >0 V< or >Hold Value< or >10 V<

- **Path Velocity**

If multiple flow velocity sensors are used and the average flow velocity of the individual measuring paths is to be determined, the desired flow velocity sensor can be selected and its measured value output in analogue form.

- Selection/input options:  
 v-Path: >Path 1< or >Path 2<, depending on how many paths are connected  
 Output range: >0-5 V< or >0-10 V<  
 Value at 0 V: manual input  
 Value at 5/10 V: manual input  
 Value at error: >0 V< or >Hold Value< or >10 V<

- **Sound Velocity Medium**

The transmitter detects a change of medium by means of the calculated sound velocity. This e.g. allows for the automatic drainage of oil tanks.

- Selection/input options:  
 Output range: >0-5 V< or >0-10 V<  
 Value at 0 V: manual input  
 Value at 5/10 V: manual input  
 Value at error: >0 V< or >Hold Value< or >10 V<

### 42.3.3 Digital Inputs

The transmitter is equipped with one digital input.

**Default setting:** Input inactive

The following different functions can be assigned to the digital input.

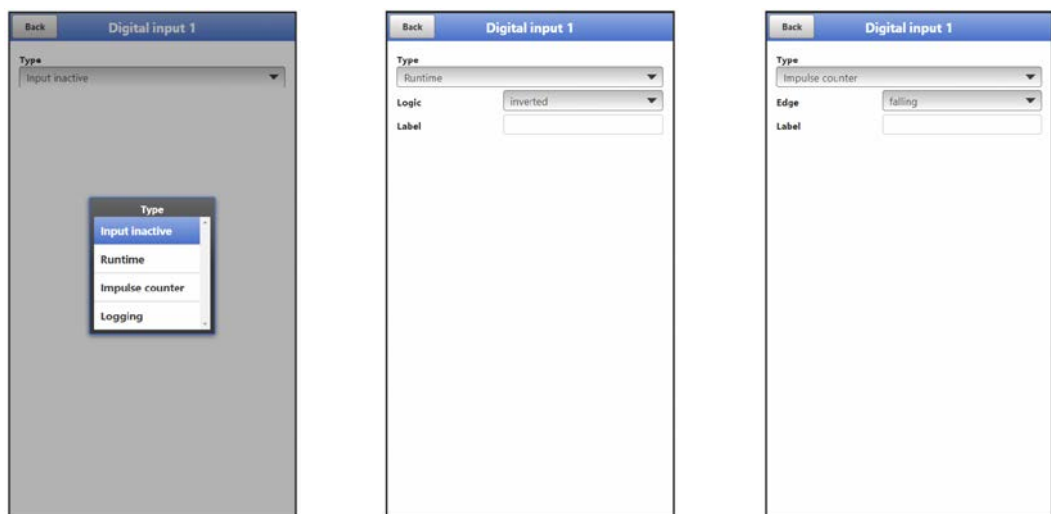


Fig. 42-12 Activation Digital Input

- **Runtime**  
The duration of the signal present at the digital input is recorded and stored by the system. This recording is used, for example, for pump or device running times. The running time is stored in seconds/recording interval.
  - Selection/input options:  
Logic: >not inverted< or >inverted<  
Designation: manual entry
- **Impulse Counter**  
The number of the signals present at the digital input is counted and stored by the system. The evaluation of the counting impulse is done by detecting the change of state of the digital input (1->0 or 0->1).
  - Selection/input options:  
Edge:  
>rising< (change of state from "0" to "1") or  
>falling< (change of state from "1" to "0")  
Designation: manual entry
- **Recording**  
Recording of the measurement values and their status changes for diagnostic purposes. The evaluation is done by detecting the change of state of the digital input (1->0 or 0->1).
  - Selection/input options:  
Logic: >not inverted< or >inverted<  
Designation: manual entry

#### 42.3.4 Digital Outputs

The transmitter is equipped with one digital output.

**Default setting:** Digital output inactive

The following different functions can be assigned to the digital output.

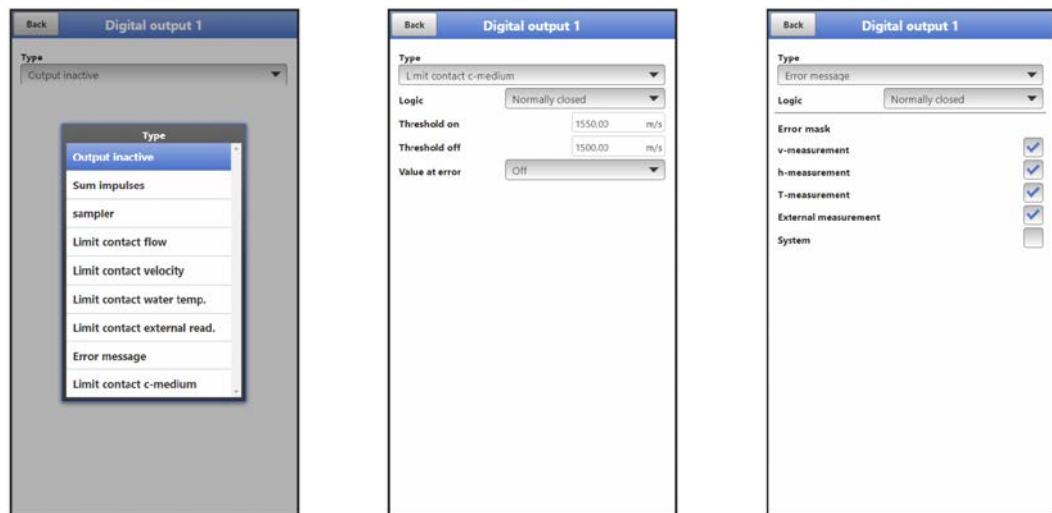


Fig. 42-13 Activation Digital Output

- **Sum Impulses**  
Quantity-proportional sum impulses are output.
  - Selection/input options:  
Logic: >Normally open< or >Normally closed<  
Negative sum impulses: check box  
Quantity: manual input  
Duration: manual input

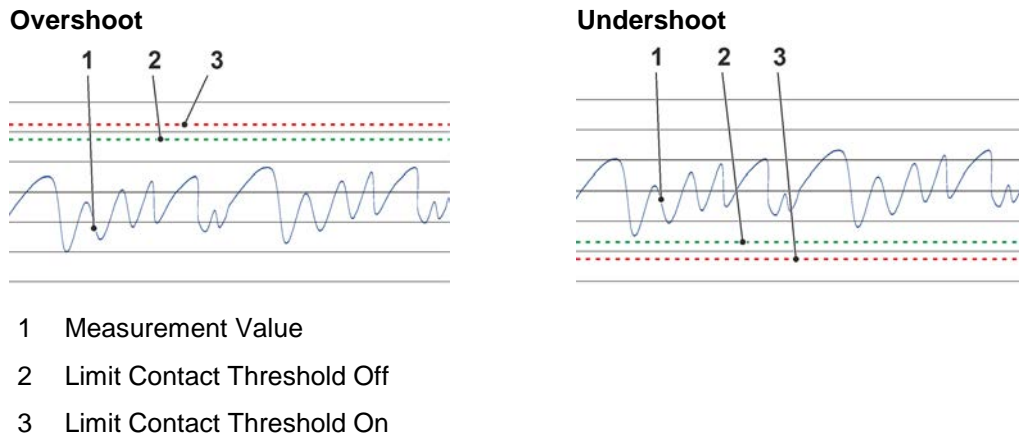


- **Sampling**

In connection with a customer's sampler, its cyclic control can be defined.

- Selection/input options:  
 Logic: >Normally open< or >Normally closed<  
 Level: manual input  
 Quantity: manual input  
 Duration: manual input

Thresholds can be defined for the following limit contacts. The definition applies either to overshoots or to undershoots, combined thresholds are not possible.



- 1 Measurement Value
- 2 Limit Contact Threshold Off
- 3 Limit Contact Threshold On

**Fig. 42-14 Limit contact overshoot/undershoot**

- **Limit Contact Flow**

A digital signal is output when the entered high flow limit value is exceeded. If the flow falls below the low flow limit value, this digital signal is reset = hysteresis function to prevent fluttering outputs.

- Selection/input options:  
 Logic: >Normally open< or >Normally closed<  
 Threshold On: manual input  
 Threshold Off: manual input  
 Value at error: >On< or >Off< or >Hold Value<

- **Limit Contact Velocity**

If the entered high velocity limit value is exceeded, a digital signal is output. If the flow falls below the low velocity limit value, this digital signal is reset = hysteresis function to prevent fluttering outputs.

The calculated average flow velocity (also calculated from several sensors) is used.

- Selection/input options:  
 Logic: >Normally open< or >Normally closed<  
 Threshold On: manual input  
 Threshold Off: manual input  
 Value at error: >On< or >Off< or >Hold Value<

- **Limit Contact Water Temperature**

A digital signal is output when the entered high water temperature limit value is exceeded.

If the flow falls below the low water temperature limit value, this digital signal is reset = hysteresis function to prevent fluttering outputs.

- Selection/input options:  
 Logic: >Normally open< or >Normally closed<  
 Threshold On: manual input  
 Threshold Off: manual input  
 Value at error: >On< or >Off< or >Hold Value<

- **Limit Contact external Reading**  
A digital signal is output when the entered high external reading limit value is exceeded. If the flow falls below the low external reading limit value, this digital signal is reset = hysteresis function to prevent fluttering outputs.
  - Selection/input options:  
Logic: >Normally open< or >Normally closed<  
Analogue input: >Input 1< or >Input 2< or >Input 3  
Threshold On: manual input  
Threshold Off: manual input  
Value at error: >On< or >Off< or >Hold Value<
  
- **Error Message**  
By activating the individual selection fields (check box) using the push button, the individual error types to be output can be assigned to the digital output. Furthermore, the output logic can be changed between normally closed and normally open function.
  - Selection/input options:  
Logic: >Normally open< or >Normally closed<  
Error mask:  
v-Measurement: check box  
h-Measurement: check box  
T-Measurement: check box  
External Reading: check box  
System: check box
  
- **Limit Contact c-Medium**  
A digital signal is output when the entered high c-medium limit value is exceeded. If the value falls below the low c-medium limit value, this digital signal is reset = hysteresis function to prevent fluttering outputs.
  - Selection/input options:  
Logic: >Normally open< or >Normally closed<  
Threshold On: manual input  
Threshold Off: manual input  
Value at error: >On< or >Off< or >Hold Value<

#### 42.4 Menu Diagnostics

The diagnostics menu is described separately in Chapter "Diagnostics" starting on page 139 of the instruction manual.

### 43 Parameter Menu Data

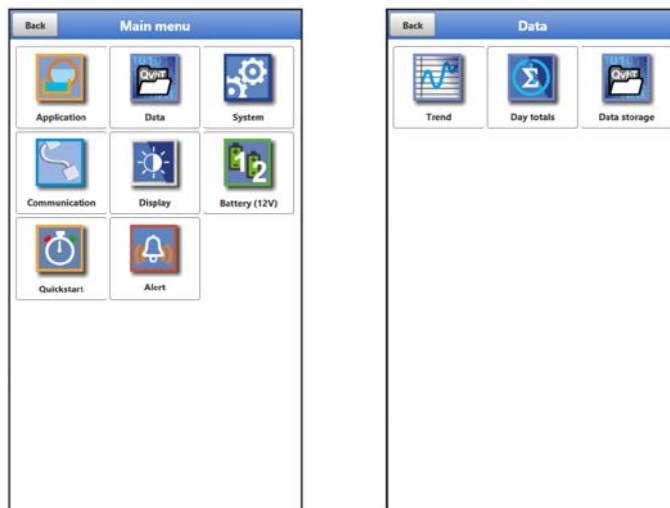
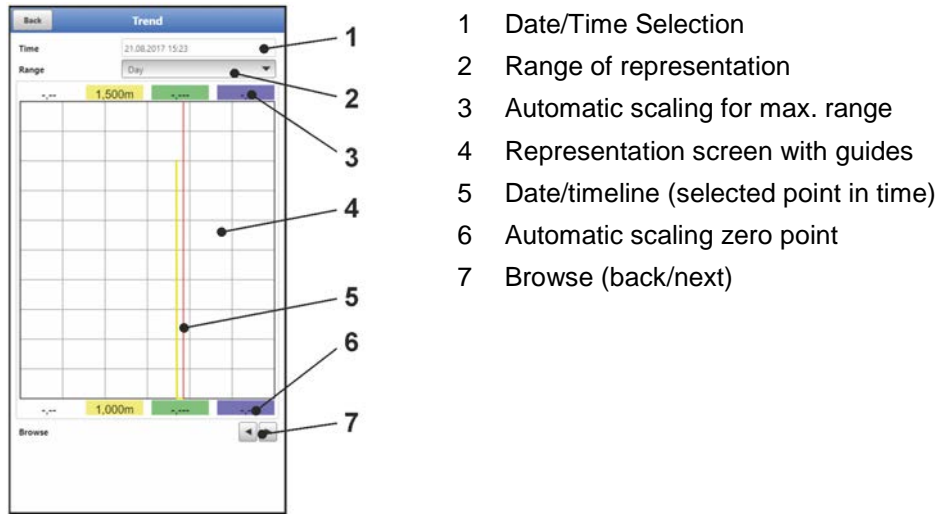


Fig. 43-1 Menu Data

## 43.1 Menu Trend

The trend display is a visualising recorder function. When the trend display is selected, current and previously stored (historical) measurement data can be accessed.



**Fig. 43-2 Representation Trend Graph**

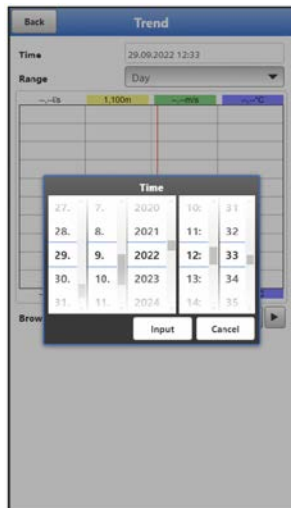
### Current Measurement Data

➡ Procedure for the representation of current readings:

1. Select the desired range (range of representation; Fig. 43-2 Pos. 2). The selected range is displayed. There is no automatic update of measurement data during indication.
2. If necessary, use the arrows (Fig. 43-2 Pos. 7) to scroll forwards and backwards with the same basic display setting.
3. Back to the main screen via "Back".

### >Date/Time Selection<

When the Trend menu is opened, the current date and time are displayed. If historical measurement data or a specific point in time is to be displayed, this can be set via the date/time selection (Fig. 43-2 Pos. 1). The selection mask shown below opens here (Fig. 43-3). If a start date is selected, (depending on the range set) the measurement data is shown in the display area below.



**Fig. 43-3 Selection Date/Time**

>Range (Period of representation)<

The selection of the range determines which period is to be displayed in the display area.

Selection	Representation in the Display Area		
	Left Margin	Right Margin	Guides
Hour	0 Minutes	59 Minutes	15 Minutes each
4 Hours	0/4/8/12/16/20 o'clock, depending on the set time	4 Hours later	1 Hour each
Day	0 o'clock	24 o'clock	4 Hours each
Week	Monday, 0 o'clock	Sunday, 24 o'clock	1 Day each
4 Weeks	Monday, 0 o'clock	4 Weeks later, Sunday, 24 o'clock	1 Week each, time reference point for the start: 29.12.1969, 0 o'clock

Tab. 7 Explanation of the periods displayed

### 43.2 Menu Day Totals

The table displayed here lists the flow total values of the last 24 hours in each case.



Date	Total	Unit
1 30.10.2018 00:00:00	0,000	m³
2 29.10.2018 00:00:00	0,000	m³
3 28.10.2018 00:00:00	0,000	m³
4 27.10.2018 00:00:00	0,000	m³
5 26.10.2018 00:00:00	0,000	m³
6 25.10.2018 00:00:00	0,000	m³
7 24.10.2018 00:00:00	0,000	m³
8 23.10.2018 00:00:00	0,000	m³
9 22.10.2018 00:00:00	0,000	m³
10 21.10.2018 00:00:00	0,000	m³
11 20.10.2018 00:00:00	0,000	m³
12 19.10.2018 00:00:00	0,000	m³
13 18.10.2018 00:00:00	0,000	m³
14 17.10.2018 00:00:00	0,000	m³
15 16.10.2018 00:00:00	0,000	m³
16 15.10.2018 00:00:00	0,000	m³
17 14.10.2018 00:00:00	0,000	m³
18 13.10.2018 00:00:00	0,000	m³
19 12.10.2018 00:00:00	0,000	m³
20 11.10.2018 00:00:00	0,000	m³
21 10.10.2018 00:00:00	0,000	m³
22 09.10.2018 00:00:00	0,000	m³
23 08.10.2018 00:00:00	0,000	m³

Fig. 43-4 Selection Day Totals

Up to 100 total values (= 100 days on which a value was recorded) are stored. From the value 101, the oldest value is overwritten (ring memory).

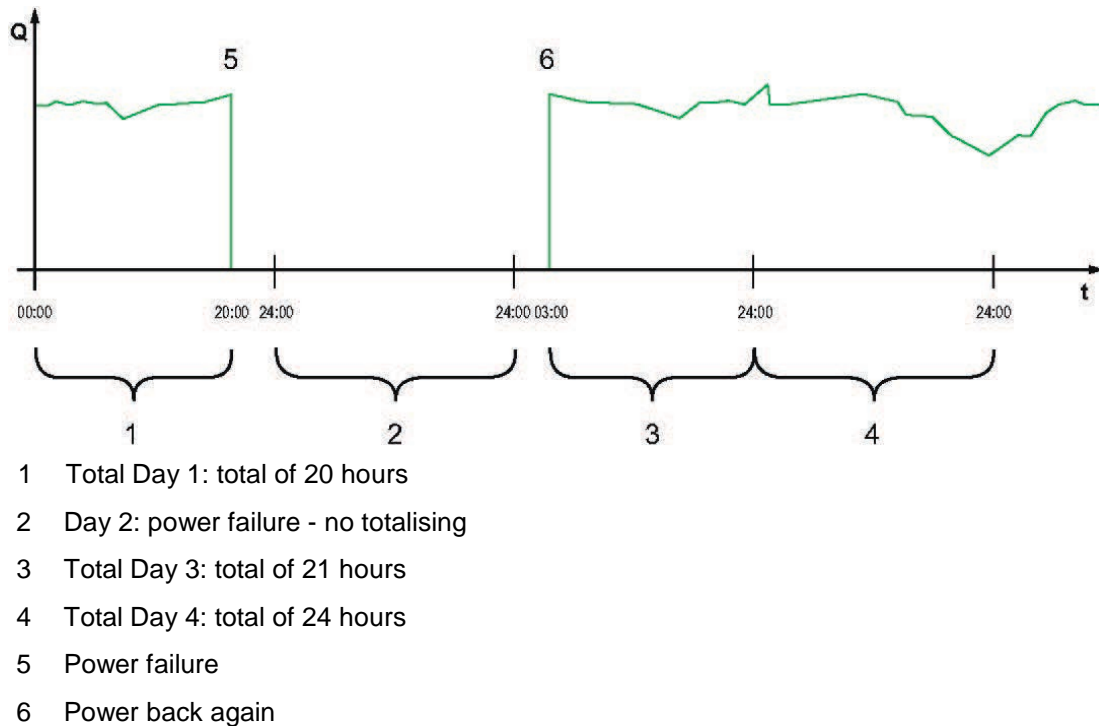
A **prerequisite** for the display of older values is that the device is also running for a longer period of time.

Example: 98 values - the device is running for 98 days

Generally, only the daily values can be read on which the transmitter was actually in operation.

If the transmitter is switched off between two totalising events (< 24 hours), the transmitter calculates a total from the **measured** values. This total does not correspond to the **actual** daily quantity that flowed, but to the quantity that the transmitter measured while it was switched on.

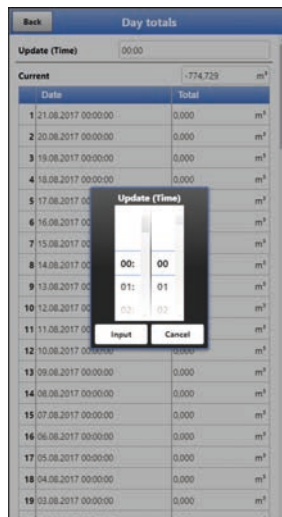
If the transmitter is switched off before the time of the next totalising and then remains switched off until the time of the next totalising (> 24 hours), the transmitter does not calculate a total for this period of time (Fig. 43-5 Pos. 2). No data is stored and the time period remains unknown. This "gap" can be recognised by the fact that the relevant entry (date/values) is completely missing in the list sequence. **No blank lines** are shown.



**Fig. 43-5 Scheme of Totalising**

- The **time period** of the totalisation is between 00:00 hrs and 24:00 hrs **by default**. This means that the daily total is always computed between 00:00 and 24:00 o'clock.
- The **time** of the totalising is 00:00 o'clock **by default**.

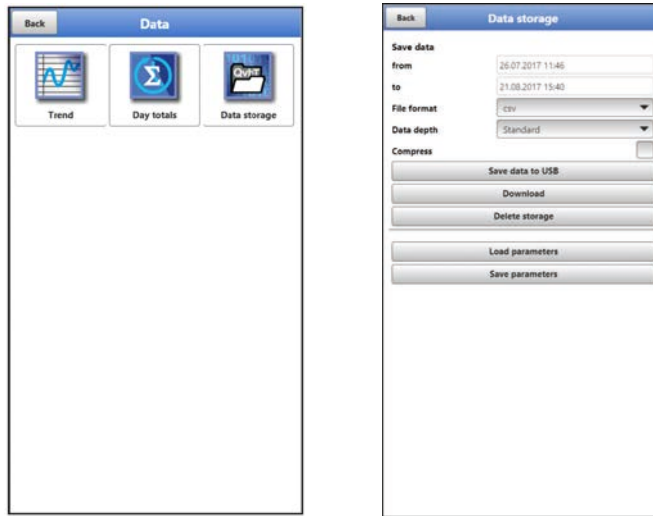
The time of totalising can be modified in >Update (Time)< (Fig. 43-6). After a change of the time, the totalising starts at the set time and ends 24 hours later.



**Fig. 43-6 Updating the totalising time**

The value displayed at >Current< corresponds to the subtotal since the last totalising.

### 43.3 Menu Data Memory



**Fig. 43-7 Menu Data Memory**

The transmitter has an internal data memory (max. 182,398 measuring cycles, after which it is overwritten). The data stored in it can be transferred partially or completely to a file or to an USB stick.



***Use of the USB interface is only permitted outside the Ex area.***

#### Requirements for the USB stick used

- formatted as FAT 32 (or FAT 12 or FAT 16) (the transmitter cannot read NTFS or exFAT)
- maximum permissible memory size 32 GB (alternatively a larger USB stick that has been "force-formatted" to FAT 32)
- Partitioning table: MBR (GPT currently not supported)



**Fig. 43-8 Set start/end time**

- **>from< / >to<**  
Sets the start and end time of the period from which the data to be transmitted originates. The selection is made in a kind of calendar (Fig. 43-8).

Per default, the transmitter offers the transmission period since the last data transmission up to the current time.

- **>File Format<**  
>csv< or >txt<
- **>Data Depth<**  
The data depth is divided into four areas. See also Tab. 8 on page 109. The two data depths >Extended< and >Expert< are additionally bookable function licences and are only available after purchase and activation (see Chap. "19.2 Add-On Function Licences" and "44.5.5 Feature Unlock").
  - **>Standard<**  
This memory format is sufficient for most applications and corresponds with the default setting.  
The stored data records contain the following information:
    - Date and time
    - Totaliser
    - Calculated flow rate
    - Average flow velocity
    - Water temperature
    - Current values as well as the values calculated from them for the activated analogue and digital inputs
    - Battery block voltage
    - Current consumption of the NFM
  - **>Extended<**  
This data set is useful for controlling critical and important applications and is mainly needed by service personnel.  
The stored data sets contain the following information:
    - All data sets from the previous data depth >Standard<
    - Average flow velocities of the v-Paths 1 and 2 (if used)
    - Average speed of sound
    - Analysis channels
  - **>Expert<**  
In this software version, the data depth >Expert< is identical to the data depth >Extended<. As part of the usual further development of the devices, subsequent software versions may well contain other functions and data.  
Such data sets should only be activated by specially trained service personnel or developers of the NIVUS GmbH. These data sets can quickly become very large.  
If necessary contact NIVUS.
  - **>Day Totals<**  
With this setting, only the daily totals are saved, not individual values.
- **>Compress<**  
This function is only useful for transmitting large amounts of data. In such a case, the selected files are zipped into the ".zip" format.
- **>Save Data to USB<**  
With this function, the measurement values of the predefined period can be saved to an USB stick.
- **>Download<**  
With this function, the measured values of the predefined period can be saved to a file on the operating device (smartphone, tablet, notebook etc.). The memory format is ".csv".
- **>Delete Memory<**  
The complete data of the internal data memory can be deleted here. After selecting, you will be asked whether you want to delete. After confirming with >Yes< the data is deleted, with >No< the process is cancelled.



### **Important Notice**

*Deleted data cannot be restored!*

- **>Load Parameters<**  
With this function a previously saved parameter file can be loaded from the USB stick or the operating device to the transmitter.
- **>Save Parameters<**  
Here the set parameterisation of the measurement place can be loaded to the USB stick. Here two files are created and saved.  
The files have the following formats:
  - **XXXX\_DOC\_AABBCCDDEE.pdf**  
This file is for documentation purposes and contains basic settings and parameter changes made.
  - **XXXX\_PAR\_AABBCCDDEE.xml**  
This file contains the complete parameter set of the transmitter. It is used to save the parameterisation that has been set.

#### **Information on File Naming:**

XXXX = Programmed name of the measurement place  
 AO = Year  
 BB = Month  
 CC = Day  
 DD = Hour  
 EE = Minute

#### **Information on the Data Depth Tables**

<b>Name</b>	<b>Data Depth</b>	<b>Meaning</b>
<b>Date</b>	Standard, Extended, Expert	Date of the table entry (time of storage)
<b>Time</b>	Standard, Extended, Expert	Time of the table entry (time of storage)
<b>app1_sum [m<sup>3</sup>]</b>	Standard, Extended, Expert	Positive flow rate total at the time of storage
<b>app1_q [l/s]</b>	Standard, Extended, Expert	Flow volume at the time of storage, value calculated by the measurement system
<b>app1_h [m]</b>	Standard, Extended, Expert	Filling level at the time of storage, value used by the measurement system
<b>app1_v [m/s]</b>	Standard, Extended, Expert	Average velocity at the time of storage, value used by the measurement system
<b>app1_t_water [°C]</b>	Standard, Extended, Expert	Water temperature at the time of storage
<b>app1_U_batt [V]</b>	Standard, Extended, Expert	Supply Voltage



<b>app1_l_batt [mA]</b>	Standard, Extended, Expert	Current in measuring mode
<b>ain1_curr [mA]</b>	Standard, Extended, Expert	Current value present at analogue input 1
<b>ain1_val [m]</b>	Standard, Extended, Expert	Measurement value analogue input 1
<b>ain2_curr [mA]</b>	Standard, Extended, Expert	Current value present at analogue input 2
<b>ain2_val [pH]</b>	Standard, Extended, Expert	Measurement value analogue input 2
<b>ain3_curr [mA]</b>	Standard, Extended, Expert	Current value present at analogue input 3
<b>ain3_val [m]</b>	Standard, Extended, Expert	Measurement value analogue input 3
<b>din1_val [-]</b>	Standard, Extended, Expert	Value at digital input 1
<b>app1_c_medium [m/s]</b>	Extended, Expert	Average Sound Velocity
<b>p&lt;x&gt;_v [m/s]</b>	Extended, Expert	Average velocity of the path <x> (x is placeholder for the sensor number: p1, p2, p3 etc.)
<b>p&lt;x&gt;_g_srch [dB]</b>	Extended, Expert	Signal amplification of the path <x> search scan (x is placeholder for the sensor number: p1, p2, p3 etc.)
<b>p&lt;x&gt;_g_sig [dB]</b>	Extended, Expert	Signal amplification of the path <x> measurement signal (x is placeholder for the sensor number: p1, p2, p3 etc.)
<b>p&lt;x&gt;_ntyp_up [dBμ]</b>	Extended, Expert	Typical noise on channel <x> against the direction of flow / upstream (x is placeholder for the sensor number: p1, p2, p3 etc.)
<b>p&lt;x&gt;_nmax_up [dBμ]</b>	Extended, Expert	Maximum noise on channel <x> against the direction of flow / upstream (x is placeholder for the sensor number: p1, p2, p3 etc.)
<b>p&lt;x&gt;_ntyp_dn [dBμ]</b>	Extended, Expert	Typical noise on channel <x> with the direction of flow / downstream (x is placeholder for the sensor number: p1, p2, p3 etc.)
<b>p&lt;x&gt;_nmax_dn [dBμ]</b>	Extended, Expert	Maximum noise on channel <x> with the direction of flow / downstream (x is placeholder for the sensor number: p1, p2, p3 etc.)
<b>diag_badblocks [-]</b>	Expert	NIVUS-internal analysis channels
<b>diag_mappedblocks [-]</b>	Expert	NIVUS-internal analysis channels

**Tab. 8 Information on the data (data depth)**

## 44 Parameter Menu System

### 44.1 Menu Information



**Fig. 43-1 Menu – System – Information**

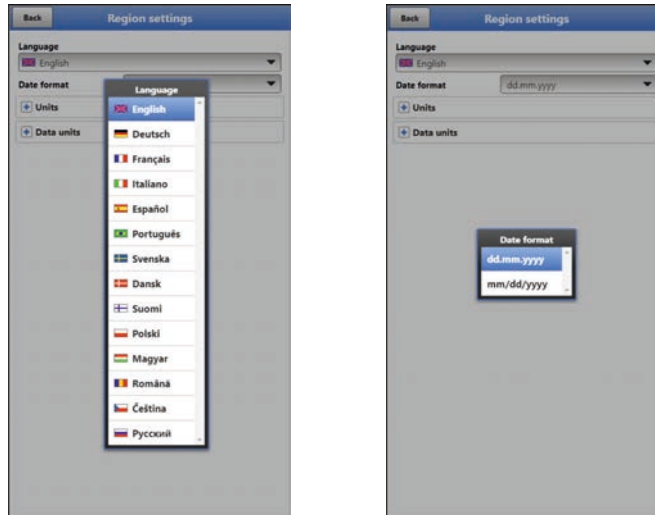
The menu >Information< is a display menu. It contains the following information on the device:

- Serial number and article number
- MAC Address
- Transmitter firmware version
- Specifications on the bootloader and the WLAN version
- Date of the last software update (firmware) and the last parameter storage
- Current charging status of the rechargeable battery blocks (when using two battery blocks, the one with the higher state of charge is first discharged to the same voltage level, then both are discharged simultaneously)
- Information on credits and licences

### 44.2 Menu Country Settings

In this menu you can make the following settings:

- (Operating) Language
- Date Format
- Units of the measurement values  
Here it is possible to distinguish between displayed and stored measured values.



**Fig. 44-2 Country Setting - Language - Date Format**

## 44.2.1 (Operating) Language

All listed languages (Fig. 44-2) provide texts in the national language or the substitute language English.

## 44.2.2 Date Format

The following date formats can be set:

- DD.MM.YYYY (Day/Month/Year)
- MM/DD/YYYY (Month/Day/Year)

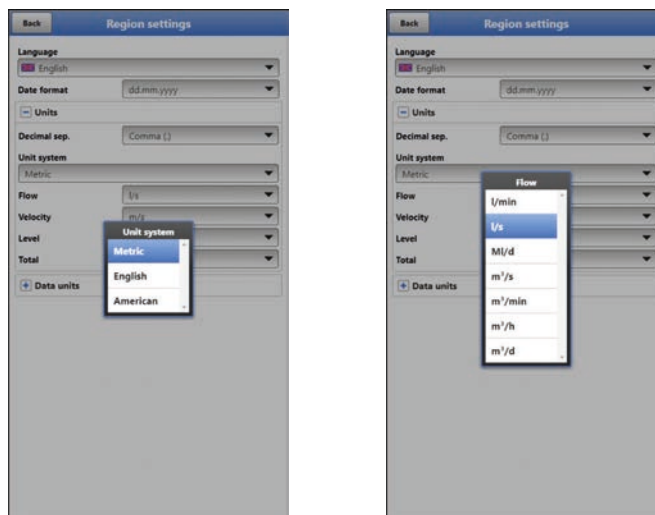
## 44.2.3 Units

At this point, various country-specific and unit system-dependent settings for the measurement values can be set.

### >Decimal Separator<

- Comma or dot

The decimal separators entered here are only used for the display of the display and operating module.



**Fig. 44-3 Units system**

### >Units System<

The choices are:

- Metric
- English
- American

The **adjustable units** depend on the previous selection of the unit system:

- In the metric system: l, m<sup>3</sup>, cm/s etc.
- In the English system: ft, in, gal/s etc.
- In the American system: fps, mgd etc.

### Units for the representation in the display for

- Flow
- Flow Velocity
- Level
- Total
- Temperature (only in unit system "English")

## 44.2.4 Data Units

The settings >Data Units< are analogous to the settings of the >Units<.

In >Data Units< the recorded measurement values are **converted and stored** according to the selected unit.



Fig. 44-4 Data units

### >Decimal Separator<

- Comma
- Dot

The specification of the decimal separators is important for the correct reading of the data. This is especially important when evaluating the measurement data with a software in a different language (e.g. English Excel), that the decimal separators are correctly selected.

### >CSV Separator<

- Comma (,)

- Semicolon (;)

This selection determines how the individual data are separated in the .csv file when reading out the data.

## >Units System<

The choices are:

- Metric
- English
- American

## Units for the Storage

- In the metric system: l/s, m<sup>3</sup>/s, m<sup>3</sup>/d, cm/s etc.
- In the English system: ft<sup>3</sup>/s, in, gal/min, Mgal/d, in/s, yd/s etc.
- In the American system: gps, gpm, cfs, cfm, cfh, cfd, mgd etc.

## Units for the Storage of Measurement Data for

- Flow
- Flow Velocity
- Level
- Total
- Temperature (only in unit system "English")

### 44.3 Menu Time/Date

In this submenu, the current date and the system time of the transmitter can be changed. The system time is based on the coordinated universal time UTC (en.: "Universal Time Coordinated"). The time zones are defined by "plus" or "minus" hours compared to UTC.

**NIVUS** strongly **recommends** keeping the system time of the transmitter and defining the respective time zone and also summer/winter times by the >Time Zone (UTC)<.

Via >**Sync Time/Date**<, the date and system time are automatically synchronised with the display and operating module.

Using the >Time/Date< menu may be necessary for the changeover from summer time to winter time, after a failure of the internal back-up battery or after a power failure.

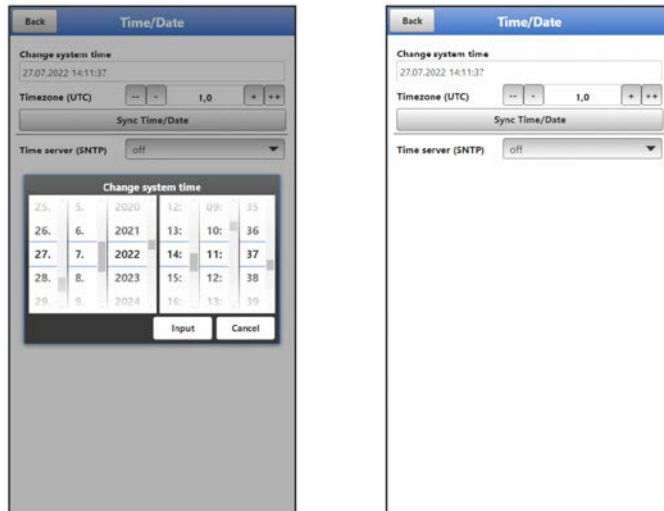
If the transmitter is operated for a longer period of time, the internal clock may deviate. These deviations can be corrected here.



#### **Effects of a System Time Change**

*Changing the system time affects the storage of the data. If data storage is activated, duplicate data or data gaps may occur after system time changes.*

---



**Fig. 44-5 Change system time: manually and automatically**

The current system time is set via the selection menu (Fig. 44-5).

The time deviation (UTC or GMT) from the prime meridian is done via the "+" and "-" fields:

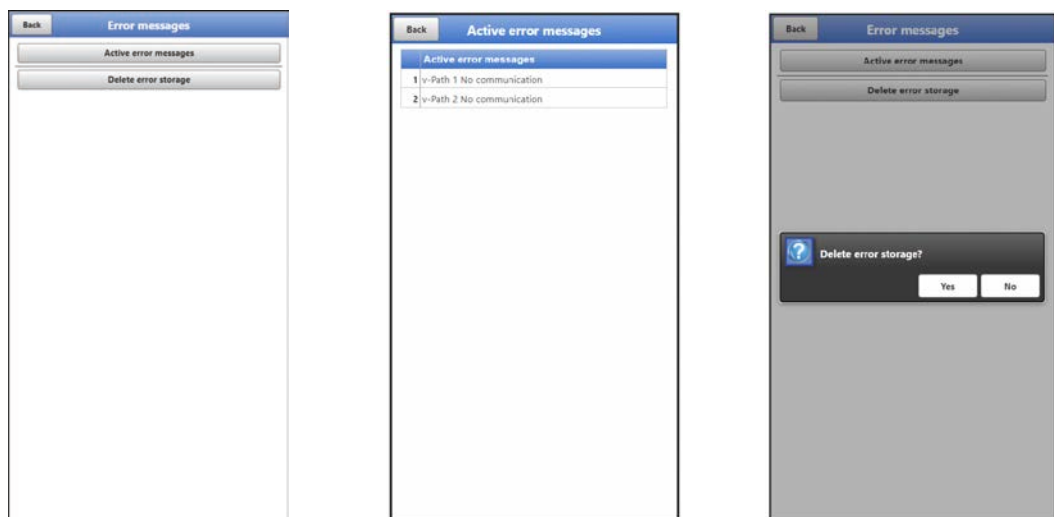
- = Decrease by 1 hour each
- = Decrease by ½ hour each
- + = Increase by ½ hour each
- ++ = Increase by 1 hour each

If **>Time Server (SNTP)<** is activated, the data logger is automatically synchronised with a time server. The SNTP protocol is used for this.

You can select from "Off", "NIVUS" and "Custom". With "Custom", the server path must also be entered.

#### 44.4 Menu Error Messages

In this menu, the current pending error messages can be called up and the error memory can be erased.



**Fig. 44-6 Error messages**

## 44.5 Menu Service

This submenu contains the following functions:

- Service levels (secured with passwords); the service levels are exclusively reserved for the NIVUS service
- Restart (of system)
- Powerdown (switching off the transmitter to energy-saving mode)
- Parameter reset (back to default settings)
- Feature Unlock
- Update NivuFlow Mobile 600
- Update Bootloader



Fig. 44-7 Service

### 44.5.1 Service Level

The service levels are divided into different access levels and protected accordingly with passwords.

The settings possible there and the information stored require extensive specialist knowledge and are not required for the usual applications. Therefore, they are reserved exclusively for NIVUS service personnel.

### 44.5.2 Restart

A restart of the transmitter interrupts the current measurement process.

The system boots using the set (saved) parameters. After booting, the system behaves as when it is switched on (analogous to the PC).

This menu point replaces switching the system off and on again. All saved parameters, counters and stored data are retained.

### 44.5.3 Powerdown

The >Powerdown< function switches the transmitter into a energy-saving mode. The unit will not resume its measuring function until it is "woken up".

During storage and transport, the >Powerdown< minimises energy consumption.

#### 44.5.4 Parameter Reset

During parameter reset, all parameters are reset to the default settings. Counter readings, changed passwords and stored measurement data are retained in the system.

The actual resetting of the parameters is only carried out after exiting the service menu (back to the main menu) and confirming the storage. The process can still be cancelled at this point.

#### 44.5.5 Feature Unlock

Special (optionally available) functions can be enabled via the feature unlock, provided these have been ordered from NIVUS.

*Info:*

*The following is an example of the procedure for activating the licence "FTP/SMTP Client" (NFM LIZENZ FTP). The procedure for all other optionally available functions is similar.*

##### Function Description "FTP/SMTP Client"

The remote data transmission can be transmitted via different channels. Basically possible:

- Via MQTT to the NIVUS WebPortal or to a customer system
- Via FTP to the NIVUS D2W data portal to a customer FTP server
- Via e-mail to a pre-defined address



**Fig. 44-8 Menu Communication Mobile Phone**

All NivuFlow Mobile devices are delivered in the basic version with the version for "MQTT Data Transmission". This variant is automatically activated and available immediately after the initial commissioning and corresponding parameterisation.

Data transfer via FTP and e-mail is additionally available via a combined licence and can either be ordered when placing the order or subsequently at any time.

The link to the NIVUS WebPortal (for the activation of this licence) will be sent by e-mail to the customer or the responsible country representative \*1) after dispatch of the ordered device or following the subsequent licence order. Manual activation is carried out by the user \*1) (see Chap. "Activation of the Licence"). As soon as the NivuFlow Mobile is parameterised accordingly, the data transmission variant can be selected and the data transmission started.



Parameter settings see Chap. "45 Parameter Menu Communication" (for the described example).



**One licence** is only valid for exactly **one device** and is permanently assigned to it through the **serial number**.

\*1) Depending on the recipient country, the licence is activated by the responsible country representative even before the unit is shipped to the customer; all ordered features are then immediately available to the customer.

## Activation of the Licence

➡ Procedure for **ordering a device with a licence** using the example of "FTP/e-mail data transfer":

1. Place order for NivuFlow Mobile device with the respective licence(s) for remote data transmission.  
Internally at NIVUS, processes are started which, on the one hand, concern the production of the NFM device and, on the other hand, initiate the licensing process.
2. After receiving the NFM device, log in to the NIVUS WebPortal and open the "Licences" tab. The access data was sent in advance by NIVUS via e-mail to an agreed e-mail address.

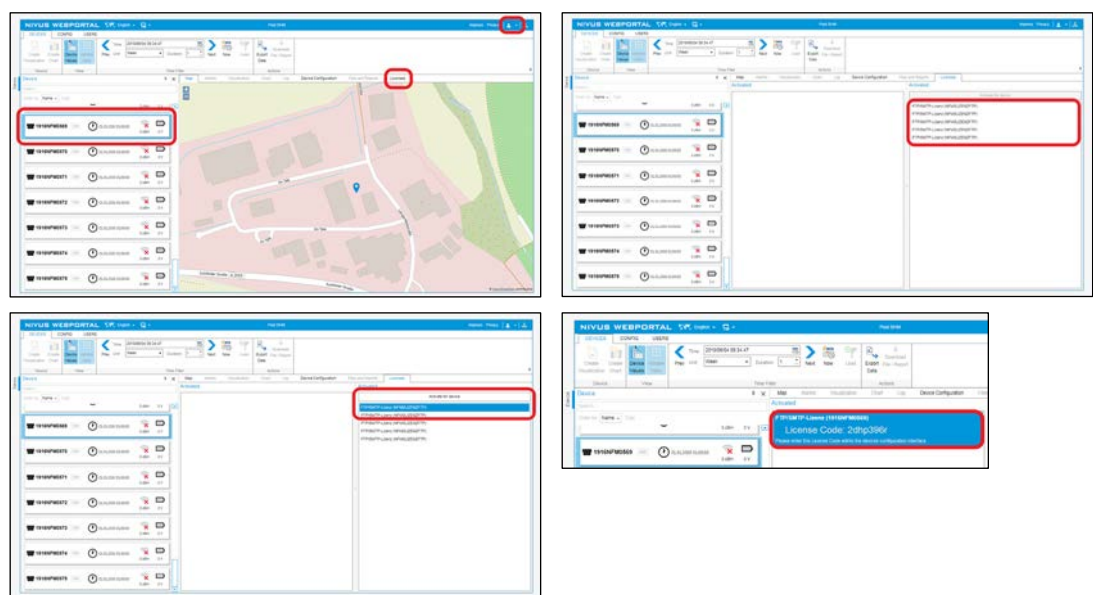


### **Assignment of the licence to the device unchangeable after being carried out**

*One licence is only valid for exactly one device and is permanently assigned to it through the serial number. This assignment cannot be changed or cannot be undone.*

*Before assigning, check exactly which device must/should be linked to which licence so that the correct device also receives the licence and can use this feature.*

3. The existing NFM device(s) is (are) listed in the NIVUS WebPortal. The ordered licences are displayed in the right-hand display field. These licences must be linked to the units via the serial numbers.  
To do this, select the corresponding licence and click on "Activate". The selected licence disappears from the right-hand display field, but the associated licence number with the activation code is displayed on the unit. This activation code is subsequently required (once) for the parameterisation of the individual devices.
4. Proceed in the same way with other licences.
5. Log out from the NIVUS WebPortal and exit the application.



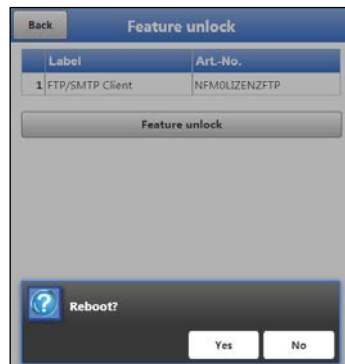
**Fig. 44-9 Activation of the licence in the WebPortal**

6. Open the display and operating module (smartphone, tablet, notebook, PC etc.) for the respective NFM and select >Feature Unlock< (Fig. 44-10) in the Service menu (see the instruction manual of the device).
7. Click the >Feature Unlock< button.
8. Enter the corresponding activation code and confirm with Enter. The linked licence is shown in the display.



**Fig. 44-10 Activation of the licence in the NFM display tool**

9. The NFM confirms the activation and requests a device restart. In the menu Communication Mobile Phone, the data transfer via FTP / e-mail option is now available.
10. Select/enter and save parameters in the >Communication< menu.



**Fig. 44-11 System reboot after activation**

- ➡ Procedure for **later ordering the licence** "FTP/E-Mail Data Transmission":
1. Place order for the desired licence(s) for remote data transmission. Internally at NIVUS, processes are started which initiate the licensing process.
  2. After receiving the access data, log in to the NIVUS WebPortal and open the "Licences" tab. The access data was sent by NIVUS via e-mail to an agreed e-mail address.
  3. Proceed with working step 3 described in section "Procedure for **ordering a device with a licence** using the example of "FTP/e-mail data transfer". Please also note the important information on "Assignment of the licence to the device" on page 117.

## 44.5.6 Update NivuFlow Mobile 600

Upload of a NivuFlow Mobile firmware saved on USB.



### Important Notice

*Update only in consultation with NIVUS GmbH or the responsible local (country) representation.*

## 44.5.7 Update Bootloader

Upload of a bootloader software saved on USB.

*Information on the bootloader/transmitter firmware version:*

*To update the bootloader to firmware version V2.00, at least firmware version V4.00 of the NivuFlow Mobile 600 transmitter must be available.*

*A firmware downgrade of the bootloader is not permitted.*

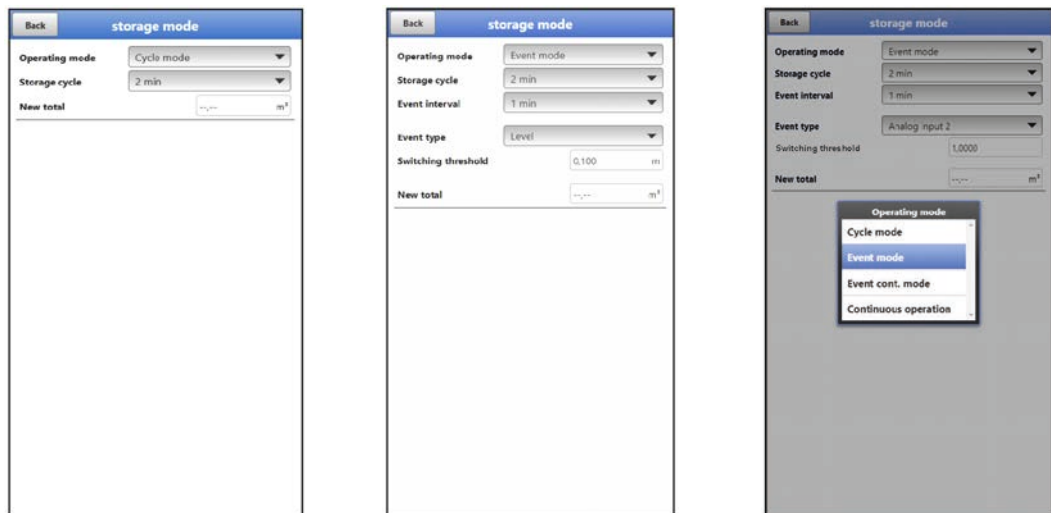


### Important Notice

*Update only in consultation with NIVUS GmbH or the responsible local (country) representation.*

## 44.6 Menu Storage Mode

In the >Storage Mode< menu, the >Operating Mode< and the >Storage Cycle< are set. Depending on the selected operating mode, the further settings described below are possible.



**Fig. 44-12 Storage Mode – Operating Mode**

### Operating Mode, Storage Cycle and Event Interval

The selected operating mode determines when and how often the transmitter should take measurements and also save them. Depending on the operating mode, the storage cycle, the event interval and the event type can be set.

The choices for >Operating Mode< are:

- **>Cycle Mode<**  
The transmitter wakes up at the intervals of the set storage cycle, measures for a short time and stores the determined measurement values. After that, the transmitter goes back into the "Sleep Phase" until the next measurement.

- **>Event Mode<**

The event mode is an extended cycle mode. It has the same parameters and functionality as the cycle mode. In addition, it is possible to switch to the >Event Interval< by recognising that a defined measurand has been exceeded or undershot (see page 120). The measurand that triggers event operation is defined via the >Event Type< (see page 120).

In the event interval the transmitter measures cyclically. The event interval can contain much shorter measuring cycles than the cycle mode. This achieves a better measurement value resolution in important time ranges.

- **>Event Continuous Mode<**

The event continuous mode and its parameter settings are largely identical to the event mode.

In contrast, the transmitter does not switch off cyclically in the event interval during the event to save energy, but measures in continuous operation. The data is averaged over the entire time span of the event interval and stored in the cycle of the event interval. The event continuous mode thus consumes slightly more energy than the event mode, but leads to more consistent measurement results for events with strongly fluctuating measured values (e.g. due to waves).

- **>Continuous Operation<**

The transmitter measures continuously, but stores the measured values only at the intervals of the set storage cycle. The permanently determined individual measured values are averaged internally. The average value of the measured values is saved.

**>Storage Cycle<**

Selection (depending on the operating mode set): (5 s, 10 s, 20 s, 30 s,) 1 min, 2 min, 3 min, 4 min, 5 min, 6 min, 10 min, 12 min, 15 min, 20 min, 30 min and 1 h

**>Event Interval <**

Setting options: 1 min, 2 min, 3 min, 4 min, 5 min, 6 min and 10 min

**>Event Type<** (only for Event Mode and Event Continuous Mode)

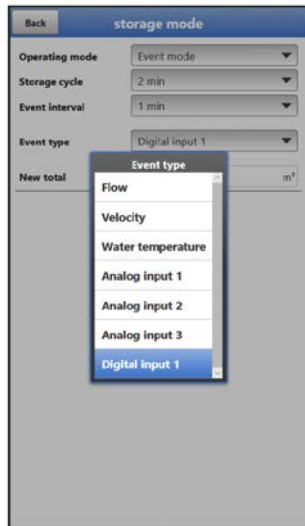
In the operating modes "Event Mode" and "Event Continuous Mode", depending on the parameters set the event types "Flow", "Velocity", "Water Temperature", "Analogue Input 1", "Analogue Input 2", "Analogue Input 3" and "Digital Input 1" can be also selected.

Except for "Digital Input 1", the **>Switching Threshold<** for the switchover can be defined in each case.

The displayed selection of event types varies depending on the parameterisation.

**>New Total<**

Here the flow rate can be reset to "0" or a new (base) value for the flow rate can be entered. For example, after a necessary replacement of the transmitter or when setting the parameters for a new measurement place.

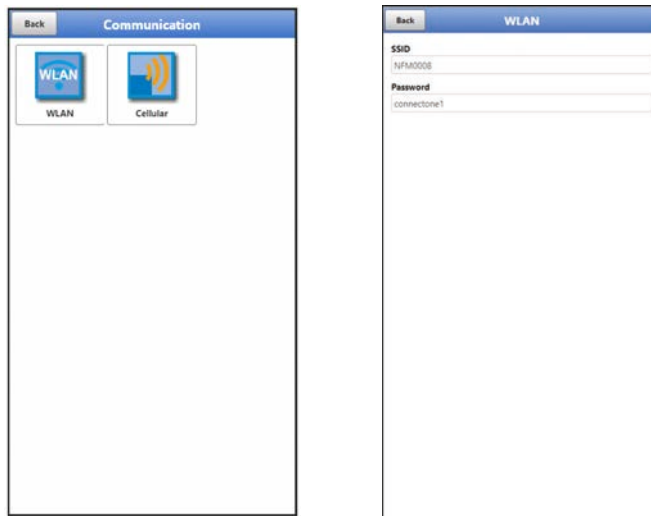


**Fig. 44-13 Event Types**

## 45 Parameter Menu Communication

In this menu, communication is established with the display and operating module (smartphone, tablet, notebook etc.) or other devices.

Communication is carried out via WLAN and mobile phone network.



**Fig. 45-1 Menu – Communication**

Information on the SSID and the WLAN password is stored under **>WLAN<**. This menu is a display menu.

➡ To change the WLAN password see Chapter "39.2 Change WLAN Password".

### Preparing the device for data transmission

The NivuFlow Mobile transmits data to the NIVUS WebPortal by using the **>Start Data Transmission<** button. The data can be selected/displayed there. In order for the respective measuring point to be displayed correctly on the overview map in the NIVUS WebPortal, i.e. with the correct GPS coordinates, their setting must be carried out correctly once at the beginning. There is no automatic update during measurement operation.

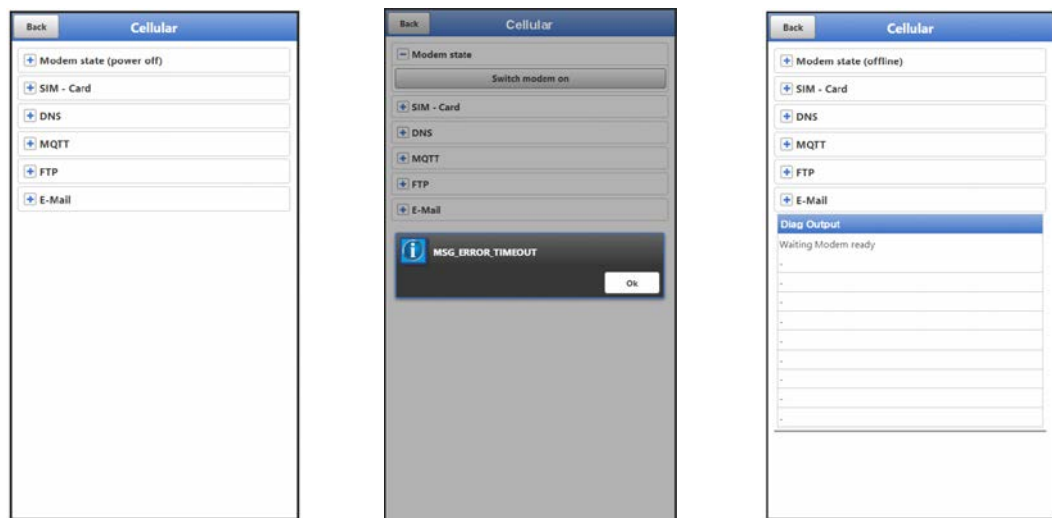
### Prerequisite

The unit must be positioned so that it has a "clear view" up to the sky. So it is best to do this before placing it in the shaft or a room.

➔ Procedure

1. Turn on the modem under >Modem Status<.
2. Wait until the device has searched for the GPS coordinates (latitude/longitude) and these have been entered in the menu (see Fig. 45-3). This may well take a few minutes.  
Without these GPS coordinates, the measuring point will not be displayed correctly on the overview map in the NIVUS WebPortal, but the data will be assigned to the correct measurement place in any case.
3. Use the >Start Data Transmission< button to send data once to ensure that the connection is successfully established and the GPS coordinates are transmitted.  
The NivuFlow Mobile can then be positioned in its planned installation location.

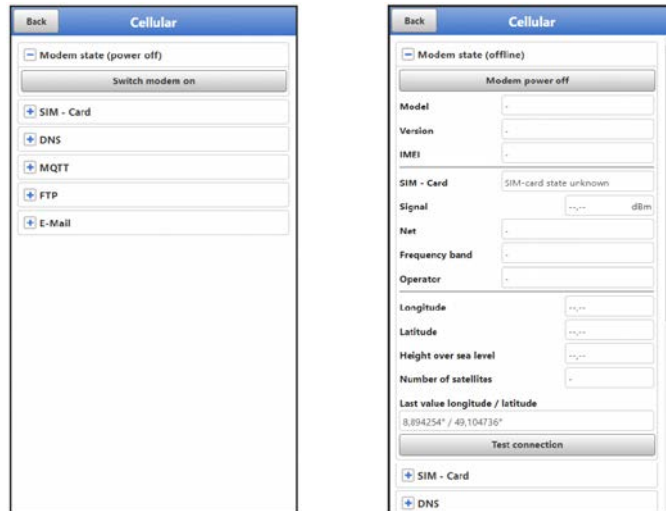
Under >Mobile< the remote data transmission is set up and parameterised.



**Fig. 45-2 Menu Mobile / Error Message Modem / Diag Output**

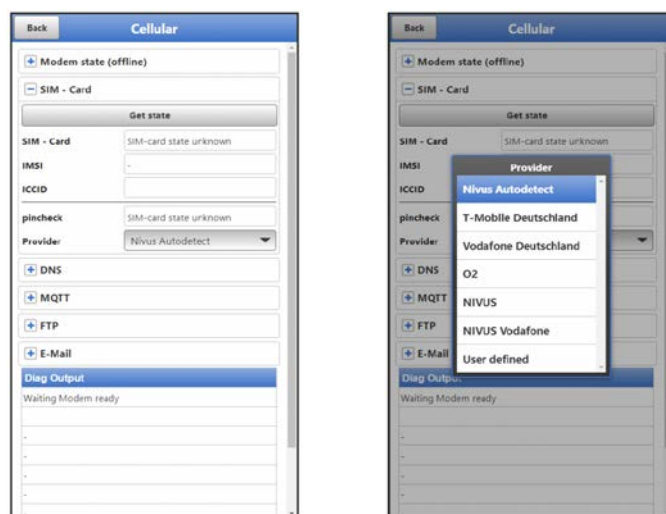
After **inserting the SIM card**, the following submenus can be used correctly. Without a SIM card, the message "ERROR" or "MSG\_ERROR\_TIMEOUT" appears and a corresponding status message is displayed in the >Diag Output<.

- >Modem State<
  - >Switch On Modem<: Modem and SIM are initialised, the modem type, the version, the IMEI and the current status of the network is displayed (signal strength, network, frequency band, operator, latitude, longitude, altitude above sea level and number of satellites).
  - >Set Up Test Connection<: After successful switch-on, a test connection can be carried out.  
During the process, a current status info appears in the >Diag Output<.



**Fig. 45-3 Modem State / SIM Card State**

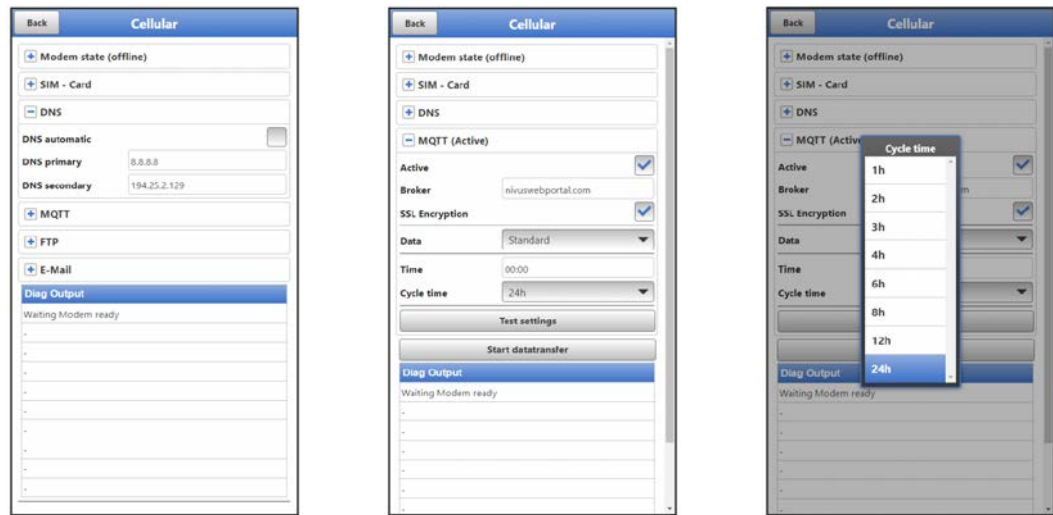
- **>SIM Card<**
  - **>Query Status<**: The status of the pin check is queried and displayed.
    - With the pin check activated, enter the corresponding PIN.
    - If the pin check is deactivated, the field can remain empty.
  - **>Activate PIN Check<**:
    - To activate, enter the PIN and select >Change PIN<.
    - To change the PIN with the pin check activated, enter the new PIN and then select >Change PIN<.
    - If the PIN was entered incorrectly 3 times, it must be entered via the PUK of the SIM card and a new PIN must be entered.
  - **>Provider<**: Select the provider; available are NIVUS automatic mode (only in connection with NIVUS SIM cards), T-Mobile Germany, Vodafone Germany, O2, NIVUS, NIVUS Vodafone and user-defined (for all customer SIM cards, except those mentioned above);  
For user-defined, enter the access data of the provider: APN (Access Point Name), possibly user name, possibly password, possibly IP address and select handshake (PAP/CHAP, PAP, CHAP).



**Fig. 45-4 SIM Card**



- **>DNS<**:  
The names are usually assigned automatically (factory setting); if a specific DNS is required by the provider, enter it.



**Fig. 45-5 DNS / MQTT**

**Factory setting for data transmission:** Transmission to the NIVUS WebPortal (MQTT). You will receive the access data from NIVUS by e-mail.

If another transmission option (>FTP< or >E-mail<; available as an additional *NFM0 LICENSE FTP* function licence \*1) is to be selected instead of this pre-set transmission, the MQTT transmission must be deactivated and then the alternative activated \*1.

\*1) See Chap. "19.2 Add-On Function Licences" and "44.5.5 Feature Unlock".

- **>MQTT<**  
Transmission to the NIVUS WebPortal; alternatively, a direct connection to customer systems can be realised via the MQTT protocol, contact the NIVUS customer service for this.
  - If the transmission is to be carried out via MQTT, activate the checkbox. The settings for transmission to the NIVUS WebPortal are already preconfigured.
  - **>Broker<**: Enter the broker name.
  - **>Port<**: enter the MQTT port.
  - Encryption via SSL can be selected optionally.
  - **>Data<**: Selection of the data depth to be transmitted (Standard, Extended and Expert; partly only as additional function licence *NFM0 LIZENZ ERW / NFM0 LIZENZ EXP*) (see Chap. "43.3 Menu Data Memory").
  - **>Time<**: Indication of the time of day at which a transmission is to be carried out.
  - **>Cycle Time<**: Setting of the transmission cycle in hours (1h, 2h, 3h, 4h, 6h, 8h, 12h or 24h).
  - **>Check Settings<**: This can be used to check the settings, the result is output in >Diag Output<.
  - **>Start Data Transmission<**: Data (error information, archive data and current values) are transmitted, the result is output in >Diag Output<.



Observe the procedure under "Preparing the device for data transmission" on page 121.



- **>FTP<**  
Transmission to a customer FTP server or to the D2W data portal.  
Available as additionally bookable function licence *NFM0 LIZENZ FTP* (see Chap. "19.2 Add-On Function Licences" and "44.5.5 Feature Unlock").
  - For transmission to a FTP server, activate the checkbox.
  - **>Server<**: Specify server name or IP.
  - **>Port<**: enter FTP port (standard 21).
  - Encryption via SSL can be selected optionally.
  - **>Authentication<**: Activate with user and password-protected FTP access and specify in user name and password.
  - **>Destination Folder<**: Enter the destination folder where the files are to be stored.
  - **>Device to Web<**: Activate when transmitting to the D2W; the Device-to-Web compatible format is applied.
  - **>File Format<**: There are csv and txt available.
  - **>Data<**: Selection of the data depth to be transmitted (Standard, Extended and Expert; partly only as additional function licence *NFM0 LIZENZ ERW / NFM0 LIZENZ EXP*) (see Chap. "43.3 Menu Data Memory").
  - **>Time<**: Specifies the time of the regular transmission; the time entered serves as the start time for the cyclic transmissions.
  - **>Cycle Time<**: Setting of the transmission cycle in minutes/hours (15min, 1h, 2h, 3h, 4h, 6h, 8h, 12h or 24h)
  - **>Check Settings<**: This can be used to check the settings, the result is output in >Diag Output<.
  - **>Start data transmission<**: Data (error information, archive data and current values) are transmitted, the result is output in >Diag Output<.

➡ Observe the procedure under "Preparing the device for data transmission" on page 121.

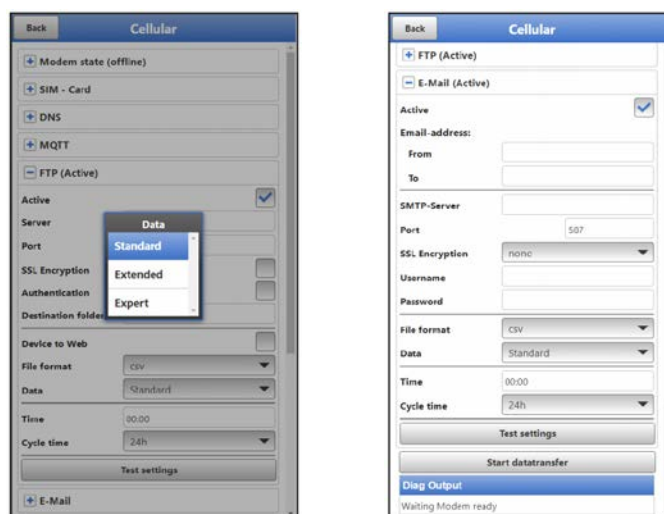


Fig. 45-6 FTP / E-Mail

- **>E-Mail<**  
Transmission to an e-mail address.  
You will receive the access data >SMTP Server<, >User Name< and >Password< from your e-mail provider.
  - For transmission to an e-mail address, activate the checkbox.

- **>E-Mail Address<:**
  - >From<: E-mail sender address (needs to be accepted by the SMTP server)
  - >To<: Enter destination e-mail address
- **>SMTP-Server<:** Enter e-mail server name (e. g. mail.gmx.net). Provider must support SMTP (Simple Mail Transfer Protokoll).
- **>Port<:** Specify the port of the SMTP outgoing mail server.
- **>SSL Encryption<** can be selected: TLS, SSL or none.
- **>User Name<:** Enter the user name of the e-mail box.
- **>Password<:** Enter the password of the e-mail box.
- **>Device to Web<:** Activate when transmitting to the D2W; the Device-to-Web compatible format is applied.
- **>File Format<:** There are csv and txt available.
- **>Data<:** Selection of the data depth to be transmitted (Standard, Extended and Expert; partly only as additional function licence *NFM0 LIZENZ ERW / NFM0 LIZENZ EXP*) (see Chap. "43.3 Menu Data Memory").
- **>Time<:** Specifies the time of the regular transmission; the time entered serves as the start time for the cyclic transmissions.
- **>Cycle Time<:** Setting of the transmission cycle in minutes/hours (15min, 1h, 2h, 3h, 4h, 6h, 8h, 12h or 24h).
- **>Check Settings<:** This can be used to check the settings, the result is output in >Diag Output<.
- **>Start data transmission<:** Data (error information, archive data and current values) are transmitted, the result is output in >Diag Output<.



Observe the procedure under "Preparing the device for data transmission" on page 121.

## 46 Parameter Menu Display

The display menu sets some attributes of the main display.  
Can be modified:

- Name of the five display fields of the main display
- Decimal places of the individual values

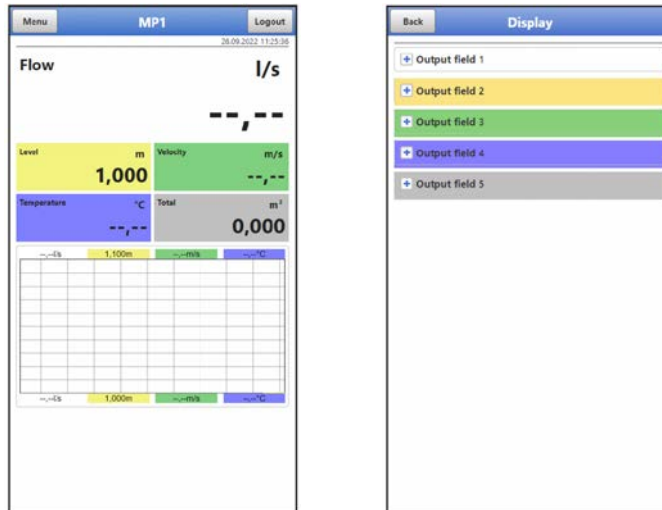


Fig. 46-1 Main display and output fields

### Output Fields

The five output fields of the main display (Flow, Level, Velocity, Temperature and Total) can be freely defined in terms of designation and number of decimal places.



#### **Assignment of the values to the output fields**

The **assignment** of the values to the fields can **NOT** be changed.

*Example: The flow rate is **always** output in the flow field, even if you have changed the designation to "Temperature".*

#### ➡ Procedure to **change the name**:

1. Expand the output field.
2. Uncheck the >Default Label< box.
3. Enter a new name. This designation is freely selectable, but the number of characters is limited to 16.  
The new name enter does **not** change the value of the fields in the main display.
4. Go "Back" several times to save the parameters.

➡ To save see Chapter "39.1 Save Parameters".

#### ➡ Procedure to **change the number of decimal places**:

1. Expand the output field.
2. Uncheck the >Standard Decimal Places< box.
3. Specify the new number of decimal places.  
Any numbers can be entered, but only up to a maximum of five decimal places are accepted.
4. Go "Back" several times to save the parameters.



---

**Setting the decimal places**

*When setting the decimal places, observe the measuring accuracies of the sensors and the set units of measurement.*

*The temperature sensor, for example, can only resolve in a 0.1 K grid.*

---

## 47 Parameter Menu Battery (12V)

In this menu, the type of rechargeable/battery used and the corresponding number are selected.



---

**Correct display of the capacity indicator**

*The capacity display in the >System< / >Information< menu only works reliably if fully charged battery blocks are used and the battery type and number of rechargeable battery blocks used are entered here.*

*At voltages <11.5 V (capacity 20 %), voltage dips and undervoltage shutdown may occur during remote data transmission.*

*NIVUS recommends replacing the rechargeable battery blocks at the latest when the remaining capacity is 20 %.*

**Tip:**

*By using two rechargeable batteries, storing and using them at non-critical temperatures (such as room temperature) and storing them dust-free, clean and dry, their capacity can be maintained for longer.*

*This means that even remote data transmission can often still function well at values below the threshold of 20 %.*

---

The choices are:

- **1x NFM0 ZAPB 1215 (E)**  
One NIVUS rechargeable battery block installed. The exact data on the rechargeable battery block are known and stored in the firmware.  
Setting the number of NIVUS battery blocks enables the correct display of the rechargeable/battery power in the menu >System< / >Information<.
- **2x NFM0 ZAPB 1215 (E)**  
Two NIVUS rechargeable battery blocks installed. The exact data on the rechargeable battery block are known and stored in the firmware.  
Setting the number of NIVUS battery blocks enables the correct display of the rechargeable/battery power in the menu >System< / >Information<.
- **BATTERIE\_MODE\_USER**  
The capacity [Ah] must be specified for the correct display of the rechargeable/battery power in the menu >System< / >Information<.

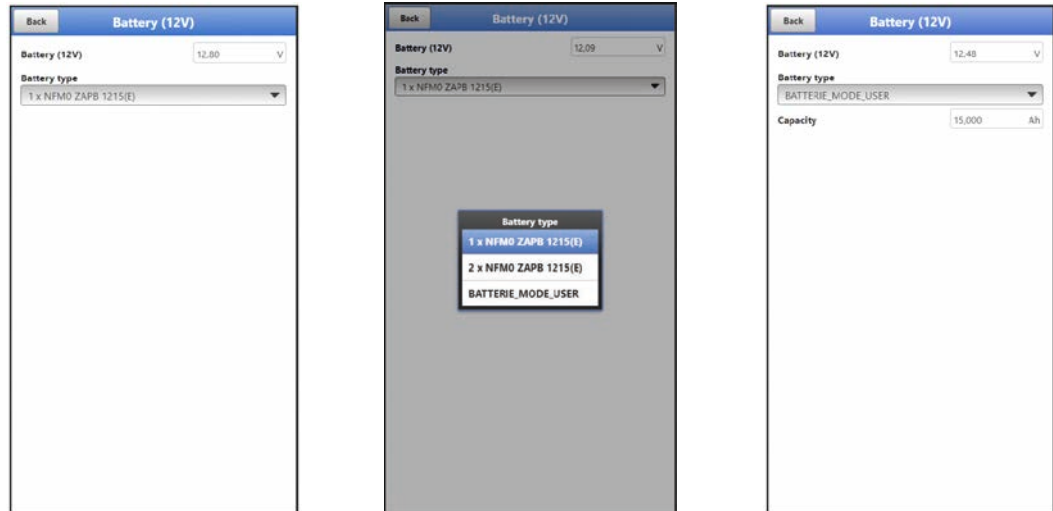


Fig. 47-1 Menu Battery (12V)

## 48 Parameter Menu Quick Start

The parameter menu >Quick Start< is divided in up to nine pages (depending on the number of v-paths). Part of the pages are input pages and define measurement place, v-sensors etc. Other pages are display pages and give information about the installation data of the sensors, the strength of the signal etc.



The procedure for setting the parameters is described in Chapter "40 Procedure for Setting Parameters via Quick Start".



**Be sure to connect the sensors before setting the parameters**

*If the transmitter detects previously connected sensors during the sensor scan, the pages for the h/v sensors are already automatically parameterised/pre-set. Detailed individual parameterisation is then no longer necessary.*

### 48.1 Menu >Quick Start< / >Country Settings<



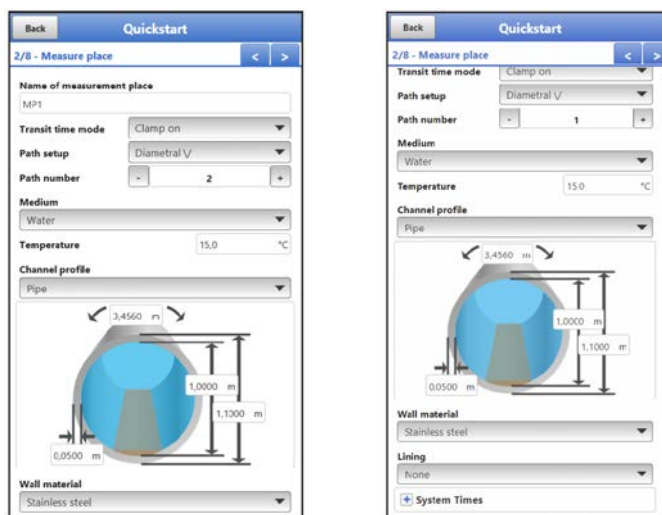
Fig. 48-1 Country Settings

Under >Country Settings< the following parameters are set:

- (Operating) Language
- Date Format
- Units and data units
- System Time, Time Zone and Time Server
- Storage mode
  - Operation Mode
  - Storage Cycle
  - (Event Interval)
  - (Event Type)
- (Switching Threshold)

⇒ The individual settings are explained in greater detail in the Chapters "44.2 Menu Country Settings", "44.3 Menu Time/Date" and "44.6 Menu Storage Mode".

## 48.2 Menu >Quick Start< / >Measurement Place<



**Fig. 48-2 Measurement Place**

Under >Measurement Place< the following parameters are set:

- Measurement Place Name
- Transit Time Mode
- Path Arrangement and Number of Paths
- Medium and Medium Temperature
- Channel Profile and Dimensions
- Wall Material and Lining
- System Times

⇒ The individual settings are explained in greater detail in Chapter "42.1 Menu Measurement Place".

## 48.3 Menu >Quick Start< / >v-Path x<



**Fig. 48-3 v-Path 1**

Under >v-Path 1< and >v-Path 2< the following parameters are shown:

- Distance Lengthwise
- Path Length
- Signal strength

The shown values for the distance lengthwise and the path length can be used for the installation of the sensors.

The signal strength is additional information: the higher the percentage, the better the signal.

## 48.4 Menu >Quick Start< / >Analogue Input x<



**Fig. 48-4 Analogue Input 1**

Under >Analogue Input 1<, >Analogue Input 2< and >Analogue Input 3< the according parameters are set for:

- External Measurement Value
- i-Sensor (HART) (only for Analogue Input 1)
- i-Sensor (4-20mA)

⇒ The individual settings are explained in Chapter "42.3.1 Analogue Inputs".

#### 48.5 Menu >Quick Start< / >Digital Input 1<



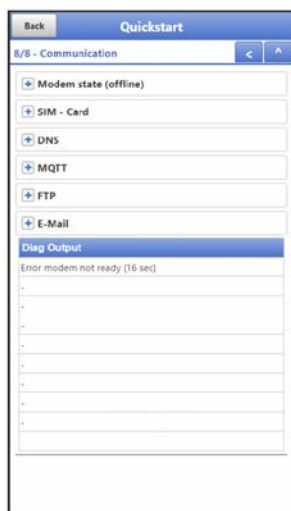
**Fig. 48-5 Digital Input 1**

Under >Digital Input 1< the according parameters are set for:

- Runtime
- Impulse Counter
- Logging

⇒ The individual settings are explained in Chapter "42.3.3 Digital Inputs".

#### 48.6 Menu >Quick Start< / >Communication<



**Fig. 48-6 Communication**

Under >Communication< all parameters in the communication sector are set via mobile phone network.

⇒ The individual settings are explained in Chapter "45 Parameter Menu Communication".



## 49 Parameter Menu Alarm

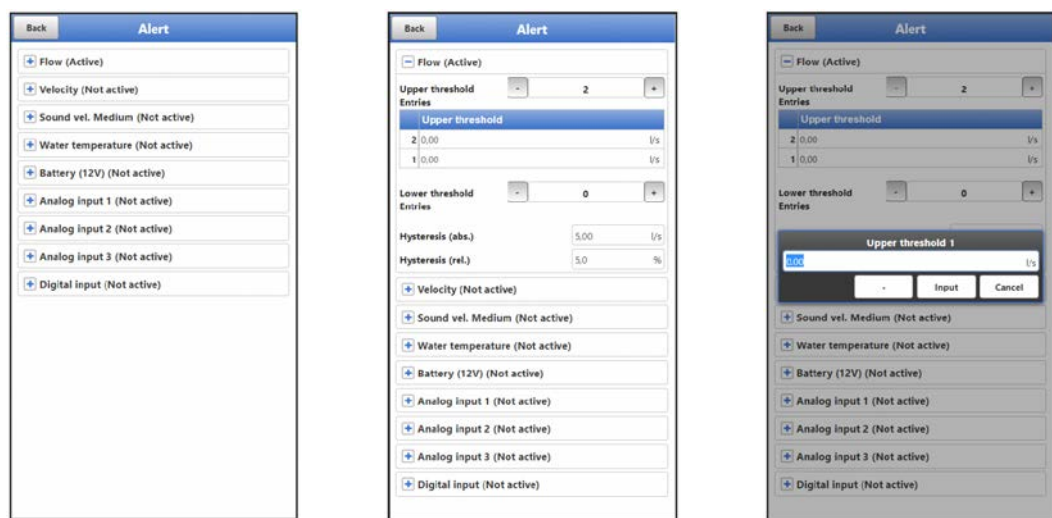
The >Alarm< parameter menu is divided into up to nine sub-items. These are >Flow<, >Velocity<, >Sound Velocity Medium<, >Water Temperature<, >Battery (12V)<, >Analogue Input 1<, >Analogue Input 2<, >Analogue Input 3< and >Digital Input<.

All sub-items are only visible if the analogue and digital inputs have previously been assigned a type under >Application< and thus activated (see Chap. "42.3.1 Analogue Inputs" and "42.3.3 Digital Inputs").



For details beyond these operating instructions, on alarm management, alarm messages, alarm overview, status information etc. see also the NIVUS WebPortal manual.

### 49.1 Menu >Alarm< / >Flow<



**Fig. 49-1 Flow**

For the >Flow< sub-item, up to five different threshold values can be entered using the "+" and "-" keys for >Upper Thresholds Entries< and for >Lower Thresholds Entries<. When these are reached, an alarm e-mail is to be issued.

The threshold values are defined by clicking on the fields and typing in numerical values. The transmitter sorts the entered threshold values in descending order. This is done independently of the input sequence.

For >Hysteresis (abs.)< and >Hysteresis (rel.)< values can be entered by clicking and typing. The transmitter evaluates the two values and sends an e-mail at the highest limit upwards (highest possible value) and at the lowest limit downwards (lowest possible value). This e-mail contains the information that the alarm has been cancelled.

#### Default Settings:

Hysteresis (abs.): values and units depend on the previously selected country settings

Hysteresis (rel.): 5.0 %



#### **Alarm E-Mail for defective Flow Velocity Sensor or Pipe that has run dry**

If an alarm e-mail is desired due to a defective flow velocity sensor or a pipe that has run dry (measurement place), the check mark for >Alarm on Error< must be set under "49.4 Menu >Alarm< / >Water Temperature<".

Here with "Flow" this is not realised, as the transmitter does not distinguish between "invalid" and "Error" during detection.

## 49.2 Menu >Alarm< / >Velocity<



Lower threshold Entries	
1	0.000 m/s
2	0.000 m/s

**Fig. 49-2 Velocity**

For the >Velocity< sub-item, up to five different threshold values can be entered using the "+" and "-" keys for >Upper Thresholds Entries< and for >Lower Thresholds Entries<. When these are reached, an alarm e-mail is to be issued.

The threshold values are defined by clicking on the fields and typing in numerical values. The transmitter sorts the entered threshold values in descending order. This is done independently of the input sequence.

For >Hysteresis (abs.)< and >Hysteresis (rel.)< values can be entered by clicking and typing. The transmitter evaluates the two values and sends an e-mail at the highest limit upwards (highest possible value) and at the lowest limit downwards (lowest possible value). This e-mail contains the information that the alarm has been cancelled.

### Default Settings:

Hysteresis (abs.): values and units depend on the previously selected country settings

Hysteresis (rel.): 5.0 %



### **Alarm E-Mail for defective Flow Velocity Sensor or Pipe that has run dry**

*If an alarm e-mail is desired due to a defective flow velocity sensor or a pipe that has run dry (measurement place), the check mark for >Alarm on Error< must be set under "49.4 Menu >Alarm< / >Water Temperature<".*

*Here with "Velocity" this is not realised, as the transmitter does not distinguish between "invalid" and "Error" during detection.*

## 49.3 Menu >Alarm< / >Sound Velocity Medium<



**Fig. 49-3 Sound Velocity Medium**

For the >Sound Velocity Medium< sub-item, up to five different threshold values can be entered using the "+" and "-" keys for **>Upper Thresholds Entries<** and for **>Lower Thresholds Entries<**. When these are reached, an alarm e-mail is to be issued.

The threshold values are defined by clicking on the fields and typing in numerical values. The transmitter sorts the entered threshold values in descending order. This is done independently of the input sequence.

For >Hysteresis (abs.)< and >Hysteresis (rel.)< values can be entered by clicking and typing. The transmitter evaluates the two values and sends an e-mail at the highest limit upwards (highest possible value) and at the lowest limit downwards (lowest possible value). This e-mail contains the information that the alarm has been cancelled.

### Default Settings:

Hysteresis (abs.): values and units depend on the previously selected country settings

Hysteresis (rel.): 5.0 %

## 49.4 Menu >Alarm< / >Water Temperature<



**Fig. 49-4 Water Temperature**

For the >Water Temperature< sub-item, up to five different threshold values can be entered using the "+" and "-" keys for **>Upper Thresholds Entries<** and for **>Lower Thresholds Entries<**. When these are reached, an alarm e-mail is to be issued.

The threshold values are defined by clicking on the fields and typing in numerical values. The transmitter sorts the entered threshold values in descending order. This is done independently of the input sequence.

For **>Hysteresis (abs.)<** and **>Hysteresis (rel.)<** values can be entered by clicking and typing. The transmitter evaluates the two values and sends an e-mail at the highest limit upwards (highest possible value) and at the lowest limit downwards (lowest possible value). This e-mail contains the information that the alarm has been cancelled.

**Default Settings:**

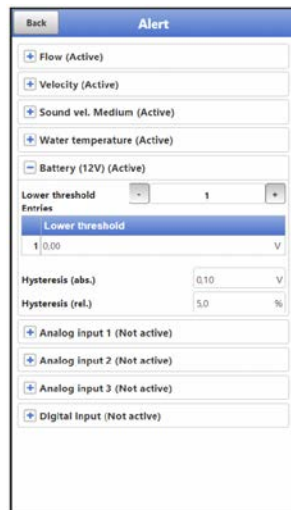
Hysteresis (abs.): values and units depend on the previously selected country settings

Hysteresis (rel.): 5.0 %

In addition, the checkbox **>Alert on Error<** can be set. Then an alarm e-mail is sent in the event of an active pending error. Such errors are e.g. cable faults, interruptions, short circuits etc.

**NIVUS recommend** checking this box to receive an alarm e-mail if a flow velocity sensor is defective or the pipe in which the measurement is being taken has run dry. Both errors lead to failure of the flow measurement.

**49.5 Menu >Alarm< / >Battery (12V)<**



**Fig. 49-5 Menu Battery (12V)**

For the **>Battery (12V)<** sub-item, up to five different threshold values can be entered using the "+" and "-" keys for **>Lower Thresholds Entries<**. When these are reached, an alarm e-mail is to be issued.

The threshold values are defined by clicking on the fields and typing in numerical values. The transmitter sorts the entered threshold values in descending order. This is done independently of the input sequence.

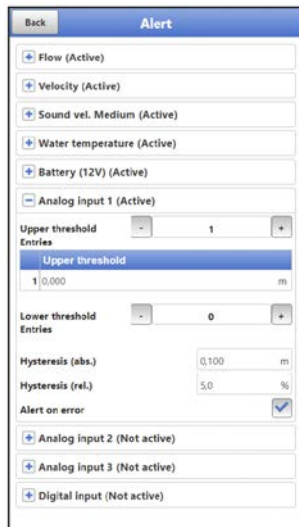
For **>Hysteresis (abs.)<** and **>Hysteresis (rel.)<** values can be entered by clicking and typing. The transmitter evaluates the two values and sends an e-mail at the highest limit upwards (highest possible value). This e-mail contains the information that the alarm has been cancelled.

**Default Settings:**

Hysteresis (abs.): 0.10 V

Hysteresis (rel.): 5.0 %

## 49.6 Menu >Alarm< / >Analogue Input x<



**Fig. 48-6 Analogue Input 1**

For the >Analogue Input x< sub-item, up to five different threshold values can be entered using the "+" and "-" keys for **>Upper Thresholds Entries<** and for **>Lower Thresholds Entries<**. When these are reached, an alarm e-mail is to be issued.

The threshold values are defined by clicking on the fields and typing in numerical values. The transmitter sorts the entered threshold values in descending order. This is done independently of the input sequence.

For **>Hysteresis (abs.)<** and **>Hysteresis (rel.)<** values can be entered by clicking and typing. The transmitter evaluates the two values and sends an e-mail at the highest limit upwards (highest possible value) and at the lowest limit downwards (lowest possible value). This e-mail contains the information that the alarm has been cancelled.

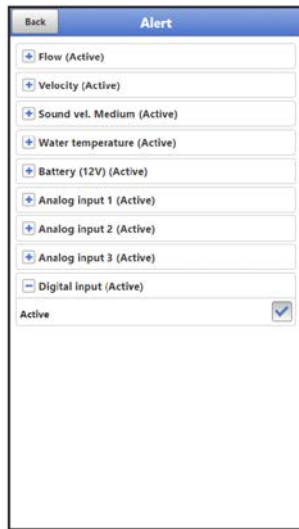
### Default Settings:

Hysteresis (abs.): any setting selectable by manual input of the analogue input parameter settings

Hysteresis (rel.): 5 %

In addition, the checkbox **>Alert on Error<** can be set. Then an alarm e-mail is sent in the event of an active pending error. Such errors are e.g. cable faults, interruptions, short circuits etc.

### 49.7 Menu >Alarm< / >Digital Input<



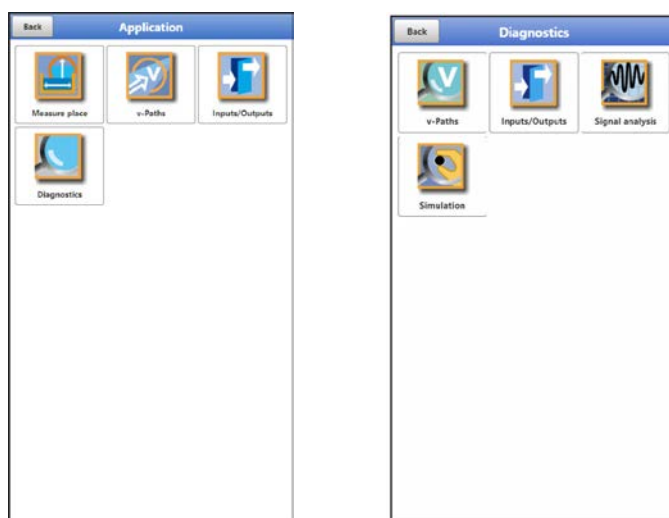
**Fig. 49-7 Digital Input**

In the sub-item >Digital Input< a check mark can be set to activate an alarm e-mail when a digital "high" occurs at the digital input.

**Default setting:** box unchecked

## Diagnostics

### 50 Basics of the Diagnostics Menu



**Fig. 50-1 Menu Diagnostics**

The menu >Diagnostics< can be found in the >Application< menu. Diagnostics is divided into four submenus.

The Diagnostics menu and all submenus are purely display and simulation menus.

In this section, settings for the following areas can be displayed or simulated:

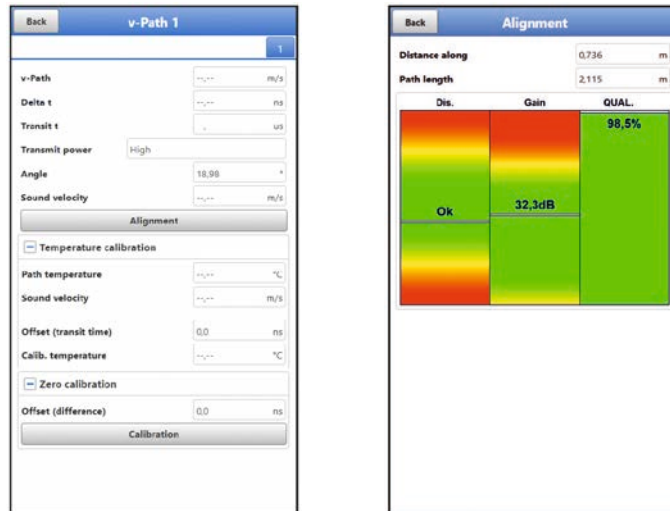
- v-Paths
- Inputs/Outputs
- Signal analysis
- Simulation



***Follow the safety instructions for the simulation***

*It is essential to follow the safety instructions for the simulation on page 141.*

## 51 Menu Diagnostics v-Paths



**Fig. 51-1 Menu Diagnostics v-Paths / Alignment**

This menu is only needed for analysis purposes.

In case of disturbances or uncertainties in the transit time measurement, various factors can be used to determine the cause.

Displayed:

- **>v-Path<**  
Display of the individual path velocities (switch over with the fields at the top right).
- **>Delta t<**  
Transit time difference in nanoseconds (to calculate the velocity  $v$ )
- **>Transit t<**  
Average signal transit time in microseconds between sensor 1 and sensor 2 of the respective path
- **>Transmitting Power<**
- **>Angle<**
- **>Alignment<**  
Aid for sensor positioning and thus for path alignment:
  - **>Dist.<** (Distance):  
Indicates via the arrow alignment whether the parameterised sensor position must be corrected due to the real conditions (move together or further away from each other). In the green range the sensor position is optimal, in the yellow and red range it has to be adjusted.
  - **>Gain<** (Amplification):  
Graphic representation of the transmitting power. Transmitting powers in the green range are optimal. In the yellow range, caution is advised, as interfering signals such as noise could lead to over- or underdrive and thus to a failure of the measurement system. In the red range, measurement is impossible: the measurement place is unsuitable for the measurement method.
  - **>Quality<**:  
The quality display indicates in % how well both sensors are installed relative to each other. This must be taken into account, particularly in clamp-on installations, as differently mounted sensors can lead to a distortion of the measurement.



- **>Temperature Adjustment<** (calculated)
  - **>Path Temperature<**  
Path temperature calculated from the sound velocity
  - **>Sound Velocity<**  
Fixed value, depending on the medium
  - **>Offset (Transit Time)<**  
Calculated value related to the value specified under "Adjustment Temperature".  
To reset the value enter "0" manually.
  - **>Adjustment Temperature<**  
Manual input of the measured ACTUAL temperature of the medium. The value is required to calculate the offset (transit time).
- **>Zero Point Adjustment<**
  - **>Offset (Difference)<** and **>Adjustment<**  
Determined value of the existing velocity under "Delta t" in the fully filled channel with the discharge closed. Is set negative and included accordingly by selecting the >Adjustment<.

## 52 Menu Diagnostics Inputs/Outputs

### 52.1 Important Information on Simulation

#### DANGER



#### ***Injuries and damage due to improper simulation***

*The simulation has an effect on downstream plant components. Disregarding may result in personal injury and damage to the system.*

*This may only be carried out by qualified electricians who have precise knowledge of the entire regulation and control process of the system.*

*Prepare the simulation in detail!*

- *Switch the downstream equipment to manual operation*
- *Switch off the actuators etc. or limit their function.*

***A safety person is absolutely necessary during the performance!***

#### DANGER



#### ***Effect on Plant Sections***

*A simulation of the NivuFlow Mobile outputs directly accesses all downstream plant sections without any safety interlock.*

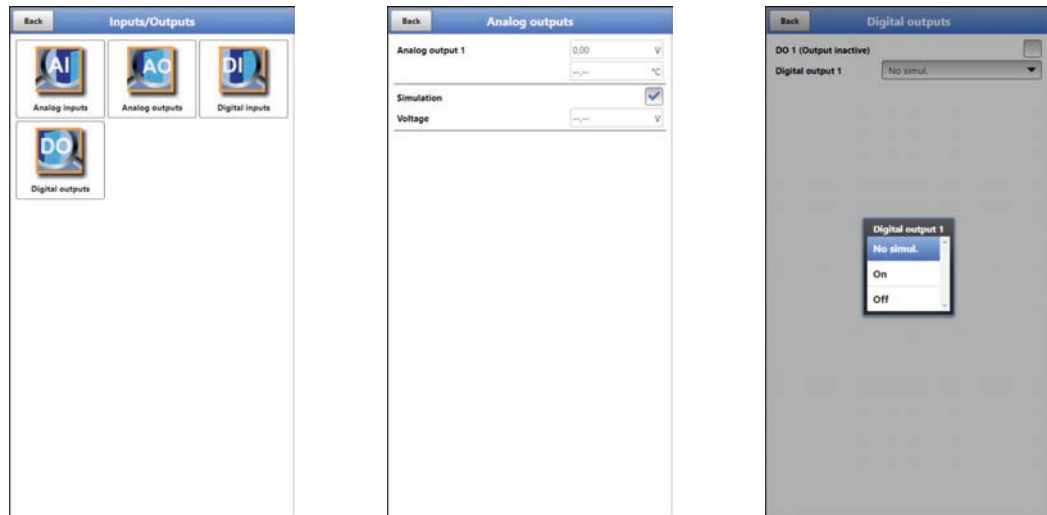
*Observe the regulations of the warning notice mentioned above!*



#### ***Important Notice***

*Due to the extremely high risk potential and the incalculable consequences of inadequate or incorrect simulation or disregard of the safety instructions, NIVUS hereby decline any responsibility whatsoever for any personal injury or damage to property in any amount!*

This menu is divided into analogue inputs, analogue outputs, digital inputs and digital outputs.



**Fig. 52-1 Menu Input/Outputs**

- **>Analogue Inputs<**  
The current values present at the respective analogue inputs and the (medium) temperature, if available, are displayed.
  - With the i-Sensor HART at analogue input 1, its individual diagnosis can also be started.  
Various commands such as “Near Blanking”, “Window Width”, “Set Blanking”, “Reset Blanking”, “Update Blanking” and “Reset Sensor” can be also executed in this menu.
- **>Analogue Outputs<**  
The applied voltage values and the determined medium temperature are displayed. By setting the checkmark for the **simulation**, a present voltage can be simulated (Fig. 52-1).  
  
**Be sure to observe the preceding safety instructions for simulation and possible hazards (consequences for the downstream system) on page 141!**
- **>Digital Inputs<**  
The menu shows present signals at the digital input with the appearance/absence of the tick.
- **>Digital Outputs<**  
Active digital outputs are identified with a tick.



### **Actually switched Relay**

*The status of the actually switched relay cannot be displayed. Only the signal that the relay receives for output is visible.*

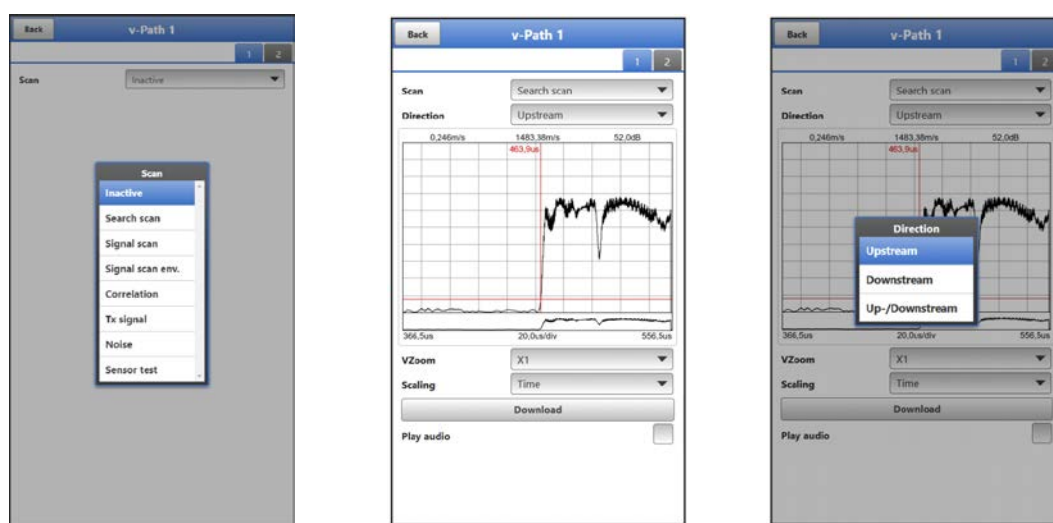
*An external faulty circuit cannot be detected and displayed in this menu.*

A **simulation** of the digital output can be determined by selecting: >No Simulation<, >On< or >Off< (Fig. 52-1).

**Be sure to observe the preceding safety instructions for simulation and possible hazards (consequences for the downstream system) on page 141!**

## 53 Menu Diagnostics Signal Analysis

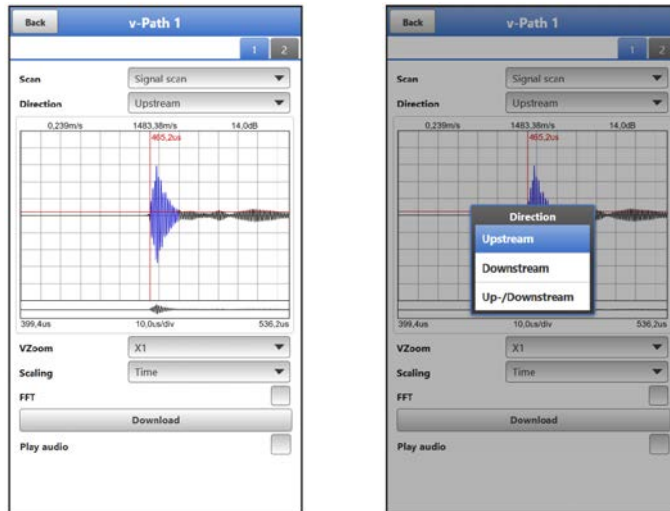
In this menu, the present sensor signal is searched for and evaluated. In addition, the functionality of the sensor can be tested.



**Fig. 53-1 Signal Analysis Selection Menu / Search Scan**

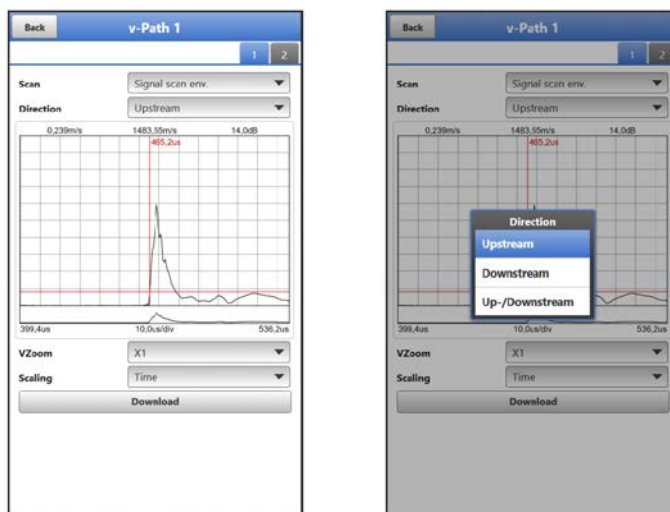
In detail, the following options are available:

- **>Inactive<**  
No signal search/evaluation
- **>Search Scan<** (Fig. 53-1)  
(Rough) search for the signal based on the client's settings and possibly a range extension.
  - **>Direction Selection<**: Upstream (against flow direction), Downstream (in flow direction) and Up-/Downstream
  - **>VZoom<** of graphic: X1, X2, X5, X10, X20 and X50
  - **>Scaling<** of graphic: time and distance
  - **>Download<**: of the current data or the screenshot (as .csv file) for analysis by NIVUS
  - **>Audio<** for acoustic support when aligning the sensors
- **>Signal Scan<** (Fig. 53-2)  
More accurate representation of the signal
  - **>Direction Selection<**: Upstream (against flow direction), Downstream (in flow direction) and Up-/Downstream
  - **>VZoom<** of graphic: X1, X2, X5, X10, X20 and X50
  - **>Scaling<** of graphic: time and distance
  - **>FFT<** to display the frequency spectrum; if the checkmark is set, the selection for scaling the graph is omitted
  - **>Download<**: of the current data or the screenshot (as .csv file) for analysis by NIVUS
  - **>Audio<** for acoustic support when aligning the sensors



**Fig. 53-2 Signal scan**

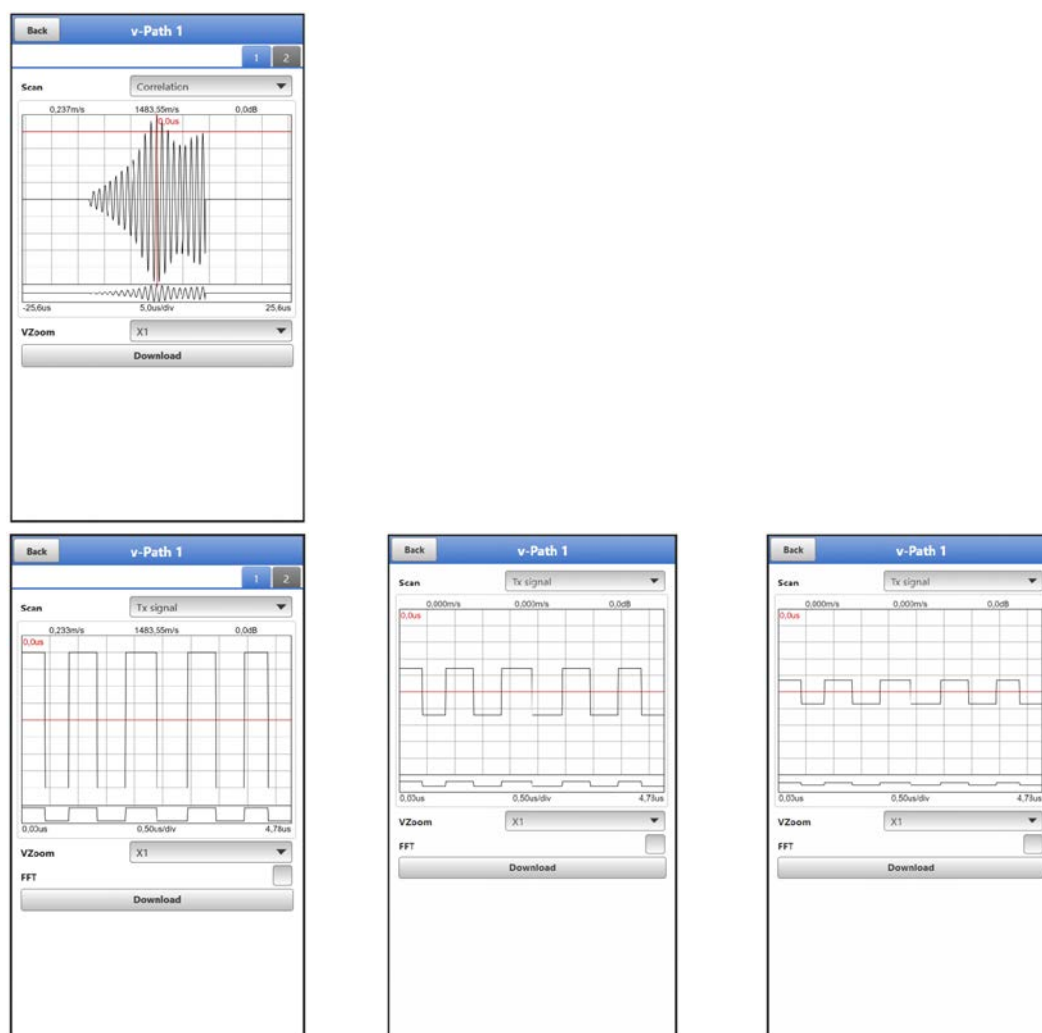
- **>Signal Scan Envelope<** (Fig. 53-3)
  - Determining the real start of the upcoming signal
    - **>Direction Selection<**: Upstream (against flow direction), Downstream (in flow direction) and Up-/Downstream
    - **>VZoom<** of graphic: X1, X2, X5, X10, X20 and X50
    - **>Scaling<** of graphic: time and distance
    - **>Download<**: of the current data or the screenshot (as .csv file) for analysis by NIVUS
    - **>Audio<** for acoustic support when aligning the sensors



**Fig. 53-3 Signal scan envelope**

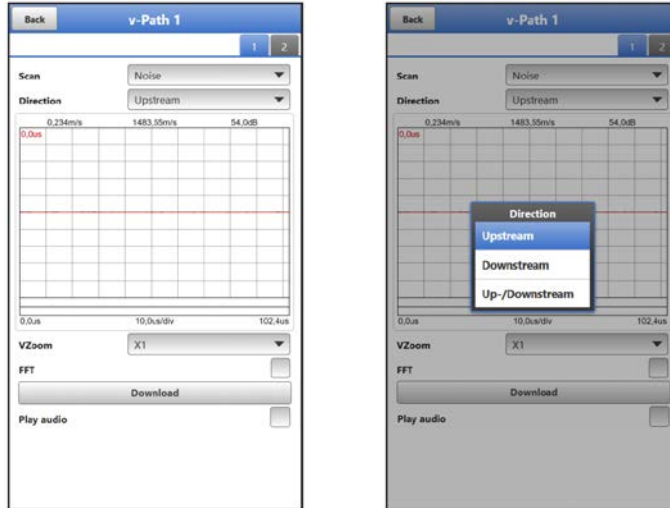
- **>Correlation<** (Fig. 53-4)
  - Mathematical comparison of the two signals.
    - **>VZoom<** of graphic: X1, X2, X5, X10, X20 and X50
    - **>Download<** of the current data or the screenshot (as .csv file) for analysis by NIVUS
- **>Transmission Signal<** (Fig. 53-4)
  - Optical representation/shape of the signal.
    - **>VZoom<** of graphic: X1, X2, X5, X10, X20 and X50

- >FFT<: for the representation of the frequency spectrum
- >Download< of the current data or the screenshots (as .csv file) for analysis by NIVUS



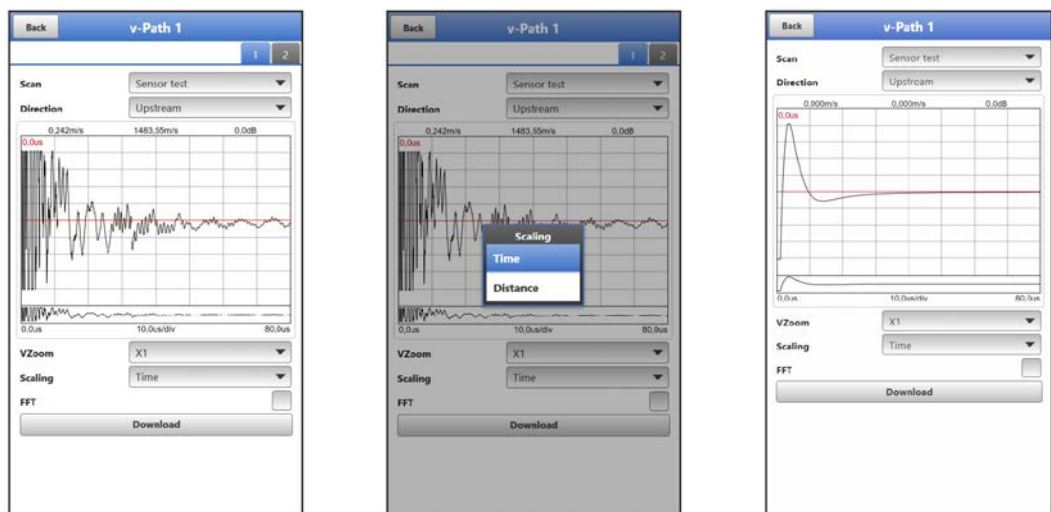
**Fig. 53-4 Correlation / transmission signal (transmitting power high / medium / low)**

- >Noise< (Fig. 53-5)
  - Display of unwanted background noise during signal evaluation.
    - >Direction Selection<: Upstream (against flow direction), Downstream (in flow direction) and Up-/Downstream
    - >VZoom< of graphic: X1, X2, X5, X10, X20 and X50
    - >FFT<: for the representation of the frequency spectrum
    - >Download< of the current data or the screenshot (as .csv file) for analysis by NIVUS
    - >Audio< for acoustic support when aligning the sensors



**Fig. 53-5 Noise**

- **>Sensor Test<** (Fig. 53-6)
  - Function test of a connected sensor; obstacles such as air and deposits are detected. If no sensor is detected (defective, cable break etc.) the curve appears like in the right picture in Fig. 53-6.
  - **>Direction Selection<**: Upstream (against flow direction), Downstream (in flow direction) and Up-/Downstream
  - **>VZoom<** of graphic: X1, X2, X5, X10, X20 and X50
  - **>Scaling<** of graphic: time and distance
  - **>FFT<** to display the frequency spectrum; if the checkmark is set, the selection for scaling the graph is omitted
  - **>Download<** of the current data or the screenshot (as .csv file) for analysis by NIVUS.



**Fig. 53-6 Signal Analysis Sensor Test / Scaling / No Sensor detected**

## 54 Simulation

### DANGER



#### **Effect on Plant Sections**

*A simulation of the NivuFlow Mobile outputs directly accesses all downstream plant sections without any safety interlock.*

*Observe the regulations of the warning notice on page 141!*

*The simulation is terminated with the "Back" field.*

In this menu, a theoretical flow can be simulated. The simulation is carried out by entering assumed filling level and velocity values. These values are **not** real.

The entry can be made in small steps via the fields >--<, >-<, >+< or >++< or to specify absolute (larger) values directly via >Velocity<.

- = Reduce the velocity by 0.01 m/s at a time
- = Reduce the velocity by 0.001 m/s at a time
- + = Increase the velocity by 0.001 m/s at a time
- ++ = Increase the velocity by 0.01 m/s at a time

The NivuFlow Mobile uses these simulated values (based on the dimensions of the parameterised channel) to calculate the prevailing flow value.

In >**Flow**< the value that was calculated is automatically displayed.

>**DO 1**< indicates which function is currently selected.

In >**Analogue Output**<, the voltage present at the previously defined output is shown.



**Fig. 54-1 Simulation**

## Troubleshooting

### 55 Possible Problems, Causes and Remedies

#	Problem/Error	Possible Reason	Problem/Troubleshooting
1	No connection between operating module and NFM	No power supply (rechargeable battery/power adapter) available.	Use (re)charged battery or power adapter (see Chap. "23.2.4 Operation/Charging with direct connection to mains power").
2		Battery empty.	Use (re)charged battery or power adapter (see Chap. "23.2.4 Operation/Charging with direct connection to mains power").
3		NFM is in sleep mode / Powerdown.	Wake up NFM with magnet or by re-contacting the power supply.
4		WLAN deactivated on the operating module.	Activate WLAN.
5		Password/SSID not entered correctly.	Enter password/SSID correctly (see inside of cover).
6		Password/SSID has been changed.	Ask colleagues for the new password/SSID or reset to factory default (see Chap. "39.2 Change WLAN Password" or "39.3 Change the device SSID").
7		Distance to the NFM is too far or obstacles (walls, ceilings, manhole covers etc.) are in between.	Reduce distance or remove obstacles.
8		In densely populated areas, other WLAN networks may be interfering - WLAN is overloaded.	Change the WLAN channel; contact the NIVUS hotline if necessary. See Chap. "56.2 Customer Service Information".
9		Incorrect IP address in the browser address field.	Use the correct IP address: 192.168.1.1
10		Browser is not up to date or incompatible.	Update browser or use different browser.
11	Status LED does not flash although the power supply is available and the NFM is awake	Internal fuse defective or LED defective or other defect in electronics.	Register/send NFM to NIVUS GmbH for repair See Chap "15 Return".
12	Sensor error (v-path has no communication)	Sensor is not recognised.	- Under >Application< / >v-Paths< / >Sensor< check whether the correct serial / article number of the sensor has been read out. - Check whether there is a cable break or loose contact. - Contact NIVUS hotline. See Chap. "56.2 Customer Service Information".
13		Sensor connected to wrong socket.	Use the correct socket.



#	Problem/Error	Possible Reason	Problem/Troubleshooting
14	No display for flow rate/flow velocity	Sensor mounted on pipe crown.	Check the installation position of the sensors: Mounting at the crown of the pipe is unsuitable as air bubbles can form in the pipe and therefore no measurement is possible. NIVUS recommends a mounting angle of $-45^{\circ}$ to $+45^{\circ}$ to the horizontal. See "Mounting Instruction Transit Time Sensors".
15		Sensor mounted on pipe bottom.	Check the installation position of the sensors: Mounting at the bottom of the pipe is unsuitable as sedimentation can form in the pipe and therefore no measurement is possible. NIVUS recommends a mounting angle of $-45^{\circ}$ to $+45^{\circ}$ to the horizontal. See "Mounting Instruction Transit Time Sensors".
16		No sensor coupling on the measurement tube (clamp-on sensors).	Check whether there is sufficient coupling grease between the measurement pipe and the clamp-on sensors or whether coupling pads are used.
17	Displayed flow rate implausible	Incorrect application parameters entered.	Check the parameterisation of the application (diameter, wall thickness, material, lining etc.).
18		Measuring section unsuitable (turbulence, asymmetrical flow pattern, calming section insufficient etc.).	Extend the calming section (see "Mounting Instruction Transit Time Sensors"). Possibly use second v-sensor path.
19		Sensor installation downstream of a stop/control valve or other disturbances on the measurement section.	Install sensor upstream of disturbance.
20		Incorrect sensor distance.	Check alignment in >Application< / >Diagnostics< / >v-Paths< / >Alignment< menu. See Chap. "51 Menu Diagnostics v-Paths".

#	Problem/Error	Possible Reason	Problem/Troubleshooting
21		The value at "Gain" (amplification) in the display graphic at >Application< / >Diagnostics< / >v-Paths< / >Alignment< is in the red range.	Causes can be present individually or in combination: <ul style="list-style-type: none"> <li>- Too many scatterers (dirt particles, air/gas bubbles) in the medium.</li> <li>- Measurement pipe is corroded on the inside.</li> <li>- Path length too long (sound path is not sufficient).</li> <li>- Pipe wall material is not homogeneous.</li> </ul>
22	Displayed temperature is implausible	If the calculated temperature deviates strongly from the set medium temperature, the parameters (diameter, wall thickness, material etc.) of the application are probably not correct.	Check parameters and correct if necessary.
23	In a 2-path measurement, the displayed flow rate is only approx. half as high as expected	One sensor (pair) is defective.	Check the individual velocity of the sensors under >Application< / >Diagnostics< / >v-Paths 1< (or 2); switch sensor connections v1/v2; replace defective sensor or change to 1-path measurement until replacement sensor is available.
24	Battery life other than expected	Only one instead of two batteries used.	Insert two batteries or adjust settings under >Battery<. See Chap. "47 Parameter Menu Battery (12V)".
25		Batteries no longer have sufficient capacity.	<ul style="list-style-type: none"> <li>- Insert other/new batteries.</li> <li>- Let NIVUS check existing batteries if necessary. Contact NIVUS hotline.</li> </ul> See Chap. "56.2 Customer Service Information".
26		Measurement was carried out in a (too) cold environment.	---
27		Incorrect operation mode or storage cycle selected.	Adjust parameters under >System< / >Storage Mode<. See Chap. "44.6 Menu Storage Mode".
28		Selected operating mode: event operation or event continuous operation - measurement was frequently in event operation in this case.	Adjust parameters under >System< / >Storage Mode<: optimise switching threshold, operating mode or storage mode if necessary. See Chap. "44.6 Menu Storage Mode".

#	Problem/Error	Possible Reason	Problem/Troubleshooting
29		Measurement duration (min. or max.) set too high.	Reduce or reset the measurement duration (min. or max.) under >Application< / >System Times< to default settings. See Chap. "42.1.12 System Times".
30		Difficult hydraulic measurement conditions.	Optimise measurement conditions, if possible.
31		Longer or more frequent data transmissions required due to poor mobile connectivity.	Optimise antenna position, if possible.
32		NFM works unscheduled in continuous operation due to frequent/permanent connection to the control unit.	Terminate connection with the "Logout" button.
33		Additional analogue sensors operated or measurement delay/duration set too high.	Optimise settings, if possible.
34	Unstable measurement value	Calming section not sufficient.	Extend calming section, if possible.
35		Measurement duration too short.	Adjust measurement duration (min. or max.) under >Application< / >System Times<. See Chap. "42.1.12 System Times".
36	Flow readings do not correspond to the expected	Dimensions of the channel profile not correctly parameterised.	Check the parameterisation of the channel profile and correct if necessary. See Chap. "42.1.6 Channel Profiles".
37		Incorrect sensor installation.	Check parameters of the v-sensor and appropriate installation: - Flow direction - Position at channel See Chap. "42.2 Menu v-Paths".
38		Asymmetric flow.	Set up second v-sensor path and use it.
39	Error Message: Error, analogue input 1/2/3, value too low	Input not connected or connected to wrong terminal.	Check wiring and correct if necessary. See Chap. "26 Connection of Sensors".
40		Sensor not plugged.	Plug the sensor in.
41		Wrong signal applied.	Apply correct signal.
42		Wrong sensor type connected.	Connect correct sensor type.
43	No readings on analogue input 1/2/3	Analogue input inactive.	Activate analogue input under >Application< / >Inputs/Outputs< / >Analogue Inputs< / >Analogue Input 1/2/3< / >Type<. See Chap. "42.3.1 Analogue Inputs".

#	Problem/Error	Possible Reason	Problem/Troubleshooting
44		Sensor-specific measurement delay and measurement duration not correctly set.	Correct values. See Chap. "42.3.1 Analogue Inputs".
45		Check technical data of sensor and NFM for suitability.	Use/install a different sensor if necessary.
46	Analogue input: Input/ output measurement values do not correspond to the expected	Valence under linearisation not correct.	Check valence and correct if necessary. See Chap. "42.3.1 Analogue Inputs".
47	No voltage at the analogue output	Output not connected or connected to wrong terminal.	Check wiring and correct if necessary. See Chap. "26 Connection of Sensors".
48		Analogue output parameterised incorrectly.	Set the analogue output parameters correctly under >Application< / >Inputs/Outputs< / >Analogue Outputs< / >Analogue Output 1<. See Chap. "42.3.2 Analogue Outputs".
49		Valence under linearisation not correct.	Check valence and correct if necessary. See Chap. "42.3.2 Analogue Outputs".
50	Analogue output: readings do not correspond to the expected	Valence under linearisation not correct.	Check valence and correct if necessary. See Chap. "42.3.2 Analogue Outputs".
51		Output section not correctly parameterised.	Check output section and correct if necessary. See Chap. "42.3.2 Analogue Outputs".
52	No readings on digital input	Input not connected or connected to wrong terminal.	Check wiring and correct if necessary. See Chap. "26 Connection of Sensors".
53		Sensor not plugged.	Plug the sensor in.
54		Digital input not correctly parameterised.	Set the digital input parameters correctly under >Application< / >Inputs/Outputs< / >Digital Inputs< / >Digital Input 1<. See Chap. "42.3.3 Digital Inputs".
55		External contact defective.	Check external contact and correct if necessary.
56	Logic of the digital input is inverted compared to what is expected	Logic parameterised incorrectly.	Check the logic parameters and correct if necessary under >Application< / >Inputs/Outputs< / >Digital Inputs< / >Digital Input 1< / >Type<. See Chap. "42.3.3 Digital Inputs".

#	Problem/Error	Possible Reason	Problem/Troubleshooting
57	Impulse counter of the digital input counts on a false edge	Edge parameterised incorrectly.	Check the edge parameters and correct if necessary under >Application< / >Inputs/Outputs< / >Digital Inputs< / >Digital Input 1< / >Type<. See Chap. "42.3.3 Digital Inputs".
58	No readings on digital output	Supply power not available.	Check supply voltage and correct if necessary.
59		Output not connected or connected to wrong terminal.	Check wiring and correct if necessary. See Chap. "26 Connection of Sensors".
60		Digital output parameterised incorrectly.	Set the digital output parameters correctly under >Application< / >Inputs/Outputs< / >Digital Outputs< / >Digital Output 1<. See Chap. "42.3.4 Digital Outputs".
61	Logic of the digital output is inverted compared to what is expected	Logic parameterised incorrectly.	Check the logic parameters and correct if necessary under >Application< / >Inputs/Outputs< / >Digital Outputs< / >Digital Output 1< / >Type<. See Chap. "42.3.4 Digital Outputs".
62			Check whether the correct contact (normally closed/normally open) is tapped; correct if necessary.
63	Sum impulses are not output	Quantity under sum impulses is entered incorrectly.	Check quantity and correct if necessary under >Application< / >Inputs/Outputs< / >Digital Outputs< / >Digital Output 1< / >Sum Impulses<. See Chap. "42.3.4 Digital Outputs".
64		Duration under sum impulses is entered incorrectly.	Check duration and correct if necessary under >Application< / >Inputs/Outputs< / >Digital Outputs< / >Digital Output 1< / >Sum Impulses<. See Chap. "42.3.4 Digital Outputs".
65	Remote data transmission to NIVUS WebPortal does not work	MQTT protocol not activated.	Activate MQTT protocol under >Communication< / >Mobile Communication< / >MQTT<. See Chap. "45 Parameter Menu Communication".
66		Diagnostics output: No SIM card detected; No SIM card plugged.	Plug in SIM card.
67		Diagnostics output: Waiting for operator; SIM card not unlocked.	Have SIM card unlocked.

#	Problem/Error	Possible Reason	Problem/Troubleshooting
68		Parameters set on customer SIM card incorrect. <i>Info: The SIM card must be configured and activated for data transmission.</i>	Under >Communication< / >Mobile< / >SIM Card< / >Provider< select "Custom" and enter the corresponding parameters such as APN, user name and password. If necessary, activate the pin check and enter the PIN of the SIM card. See Chap. "45 Parameter Menu Communication".
69		Signal strength not sufficient.	Signal under >Communication< / >Mobile< / >Modem Status< check the signal strength (the signal strength should be greater than -100 dBm). The more the value is away from 0, the worse the signal strength is. <i>Example: A signal of -80 dBm is stronger than a signal of -90 dBm.</i> Optimise antenna position, if necessary. See Chap. "45 Parameter Menu Communication".
70		NIVUS SIM card doesn't work.	Under >Communication< / >Mobile< / >SIM Card< / >Provider< check whether "NIVUS Automatic Mode" is activated. Activate if required. See Chap. "45 Parameter Menu Communication".
71	Data transmission via FTP does not work	Under >Communication< / >Mobile< there is no option to activate data transfer via FTP or e-mail.	Purchase <i>NFM0 LIZENZ FTP</i> licence from NIVUS and activate accordingly. See Chap. "19.2 Add-On Function Licences".
72		Incorrect server address entered for remote data transmission.	Enter the correct server address/IP under >Communication< / >Mobile< / >FTP< />Server<. See Chap. "45 Parameter Menu Communication".
73		Incorrect port entered for remote data transmission.	Enter the correct port under >Communication< / >Mobile< / >FTP< />Port<. See Chap. "45 Parameter Menu Communication".

#	Problem/Error	Possible Reason	Problem/Troubleshooting
74		Settings for SSL encryption not identical on NFM/server or not saved on server.	Adjust SSL encryption and correct if necessary under >Communications< / >Mobile< / >FTP< / >SSL Encryption<. See Chap. "45 Parameter Menu Communication".
75		Settings for authentication not identical on NFM/server.	Adjust the authentication and correct it if necessary under >Communication< / >Mobile< / >FTP< / >Authentication<. See Chap. "45 Parameter Menu Communication".
76		Settings for destination folder not correct.	Check destination folder and correct if necessary under >Communication< / >Mobile< / >FTP< / >Destination Folder<. See Chap. "45 Parameter Menu Communication".
77	Error messages in the NIVUS WebPortal log	ERROR-Connect no operator.	Check signal strength under >Communication< / >Mobile< / >Modem Status<; If the signal strength is poor (less than - 100 dBm; the further the value is from 0, the poorer the signal strength) try to optimise the antenna position. If the signal strength is sufficient, check whether the SIM card is activated. See Chap. "45 Parameter Menu Communication".
78		ERROR-Broker.	Check signal strength under >Communication< / >Mobile< / >Modem Status<; If the signal strength is poor (less than - 100 dBm; the further the value is from 0, the poorer the signal strength) try to optimise the antenna position. If the signal strength is sufficient, contact the NIVUS hotline. See Chap. "45 Parameter Menu Communication" or "56.2 Customer Service Information".

#	Problem/Error	Possible Reason	Problem/Troubleshooting
79		ERROR-Connect PPP Timeout.	<p>Check signal strength under &gt;Communication&lt; / &gt;Mobile&lt; / &gt;Modem Status&lt;; If the signal strength is poor (less than -100 dBm; the further the value is from 0, the poorer the signal strength) try to optimise the antenna position.</p> <p>If the signal strength is sufficient, contact the NIVUS hotline.</p> <p>See Chap. "45 Parameter Menu Communication" or "56.2 Customer Service Information".</p>

**Tab. 9 Error - Cause - Elimination**



## Maintenance and Cleaning

---

### WARNING



#### **Disconnect the System from Mains Power**

Disconnect the unit from the mains and secure the higher system against being switched on again before starting maintenance, cleaning and/or repair work (only by qualified personnel).

Disregarding may lead to electric shock.

---

### WARNING



#### **Check danger due to explosive gases**

Before starting assembly, installation and maintenance work, be sure to check that all regulations on safety at work have been observed and that there is no possible risk of explosive gases. Use a gas warner for the check.

When working in the sewer system, make sure that no electrostatic charge can occur:

- Avoid unnecessary movements to reduce the building-up of static charges.
- Discharge any static electricity present on your body before you start installing the sensor.

Disregarding may result in personal injury or damage to the system.

---

### WARNING



#### **Open the device only out of Ex areas**

Do not open, service or repair in an area where an explosive atmosphere is present.

---

### WARNING



#### **Germ Contamination**

Due to the frequent use of the sensors in the waste water sector, parts can be contaminated with dangerous germs. Therefore, appropriate precautions must be taken when coming into contact with cables and sensors.

Wear protective clothing.

---

## 56 Maintenance

### 56.1 Maintenance Interval

The Type NivuFlow Mobile transmitter is virtually free of calibration, maintenance and wear by design.

Nevertheless, NIVUS recommend an **annual check** of the entire measuring system by the NIVUS customer service.

Depending on the area of application of the measuring system, the maintenance interval may vary. The scope of maintenance and its intervals depend on the following factors:

- Measurement principle of the sensors
- Material wear
- Measurement medium and channel hydraulics
- General regulations for the operator of the measurement system
- Environmental conditions

In addition to the annual maintenance, NIVUS recommend a complete maintenance of the measuring system by the NIVUS customer service after **ten years at the latest**.

Generally, the verification of instruments and sensors is a basic measure in order to improve operational reliability and to increase the lifetime.

Contact the NIVUS customer service to make an appointment (see Chap. "56.2 Customer Service Information").

### 56.2 Customer Service Information

For the recommended annual inspection of the entire measuring system or complete maintenance after ten years at the latest, contact our customer service:

#### **NIVUS GmbH – Customer Service**

Phone +49 7262 9191-922

[customercenter@nivus.com](mailto:customercenter@nivus.com)

## 57 Cleaning

### 57.1 Transmitter

#### **WARNING**

#### ***Disconnect the System from Mains Power***



*Make sure that the device is disconnected from mains power.*

*Disregarding may lead to electric shock.*

#### **DANGER**

#### ***Danger by electrostatic Discharge***



*Clean the device only with a damp cloth.*

*In case of disregard, the explosion protection of the device is no longer given due to possible static charge.*

*The device then poses a danger to the life of the user and can cause the ignition of an explosive atmosphere.*

The NivuFlow Mobile enclosure complies with protection class IP68 when closed and is not very sensitive. Nevertheless, a high-pressure cleaner should **not** be used for cleaning.

Also, do **not** use harsh cleaning agents or solvents. Instead, it is better to use mild household cleaners or soap suds.

### 57.2 Rechargeable Battery Blocks

Do not use ethanol, petrol or other organic solvents or cleaning agents and surface-active agents to clean the rechargeable battery blocks.

Instead, it is better to use mild household cleaners or soap suds.

### 57.3 Power Adapter/Charger

Clean the power adapter/charger and charging tray only with a **slightly damp** cloth. The components do not have any protection against the ingress of moisture.

### 57.4 Transducers

Be sure to follow the instructions for maintenance and cleaning of the sensors. These instructions can be found in the respective technical description or instruction manual.

These manuals are provided with the respective sensors and/or are available as download on the NIVUS homepage.

## 58 Dismantling/Disposal

Improper disposal may be harmful to the environment.

- Dispose of device components and packaging materials in accordance with the applicable local environmental regulations for electrical products:
  1. Disconnect the device from mains power, if connected.
  2. Remove connected cables from the device.
  3. Remove rechargeable battery blocks and, if they are defective, dispose of them properly.
  4. Remove the buffer battery from the transmitter and dispose of it separately and properly.



### **EU WEEE Directive**

*This symbol indicates that the requirements of Directive 2012/19/EU on waste electrical and electronic equipment must be observed when disposing of the device. NIVUS GmbH support and promote the recycling or environmentally sound, separate collection/disposal of waste electrical and electronic equipment to protect the environments and human health. Observe the local laws and regulations on disposal.*

*NIVUS GmbH is registered with the EAR, therefore public collection and return points in Germany can be used for disposal.*

***The device is equipped with a buffer battery (lithium button cell) that must be disposed of separately.***

## 59 Installation of Spare Parts and Wearing Parts

We expressly draw your attention to the fact that spare parts and accessories which have not been supplied by us have also not been tested and approved by us. The installation and/or use of such products may therefore negatively alter or invalidate the design properties of your measurement system.

NIVUS are not liable for damage caused by the use of non-original parts and non-original accessories.

## 60 Accessories

Article No	description
NFM0 ZAPB 1215	Rechargeable battery block with connection sockets for NFM; nominal voltage: 12 V; capacity: 15 Ah
NFM0 ZAPB 1215 E	Rechargeable battery block with connection sockets for NFM with ATEX approval zone 1; nominal voltage: 12 V; capacity: 15 Ah
NFM0 ZLAD	Power adapter/charger for NFM / NFM rechargeable battery block supply voltage: 100...240 V AC, 50/60 Hz
NFM0 ZVER PS	Connection cable 2-wire for connecting an external supply voltage to the NFM (one side with plug for the multifunction socket, other side with open cable end); cable length 5 m; When connecting, be sure to observe chapter "25 10-pole/ 18-pole Plugs".
NFM0 ZAB 01	Display and operating module for NFM: IP67-certified 8" outdoor display; resolution: 1280x800; OS: Android; Device communication: WLAN; other communication types: USB, Bluetooth, modem 2G, 3G and 4G

<i>NFM0 ZVER AA</i>	<p>Connection cable, NFM analogue output (one side with plug for the multifunction socket, other side with open cable ends); cable length 10 m;</p> <p>When connecting, be sure to observe chapter "25 10-pole/ 18-pole Plugs".</p>
<i>NFM0 ZVER AEA</i>	<p>Connection cable, NFM analogue input; power supply via NFM (one side with plug for the multifunction socket, other side with open cable ends); cable length 10 m;</p> <p>When connecting, be sure to observe chapter "25 10-pole/ 18-pole Plugs".</p>
<i>NFM0 ZVER AEP</i>	<p>Connection cable, NFM analogue input; external power supply (one side with plug for the multifunction socket, other side with open cable ends); cable length 10 m;</p> <p>When connecting, be sure to observe chapter "25 10-pole/ 18-pole Plugs".</p>
<i>NFM0 ZVER DE</i>	<p>Connection cable, NFM digital input; power supply via NFM (one side with plug for the multifunction socket, other side with open cable ends); cable length 10 m;</p> <p>When connecting, be sure to observe chapter "25 10-pole/ 18-pole Plugs".</p>
<i>NFM0 ZVER DA</i>	<p>Connection cable, NFM relays output (one side with plug for the multifunction socket, other side with open cable ends); cable length 10 m;</p> <p>When connecting, be sure to observe chapter "25 10-pole/ 18-pole Plugs".</p>
<i>NFM0 ZVER NLM</i>	<p>Connection cable between NFM and NivuLog Easy (one side with plug for the multifunction socket, other side with open cable ends); cable length 5 m;</p> <p>When connecting, be sure to observe chapter "25 10-pole/ 18-pole Plugs".</p>
<i>NFM0 ZVS1</i>	<p>Connector Box, IP67 with NFM connection plug for connection to the NFM</p>
<i>ZUB0 KAB NMC 10</i>	<p>2-pole, pre-assembled cable with open cable ends for connection to the Connector Box; cable length 10 m;</p> <p>When connecting, be sure to observe chapter "25 10-pole/ 18-pole Plugs".</p>
<i>ZUB0 KAB NMC 20</i>	<p>2-pole, pre-assembled cable with open cable ends for connection to the Connector Box; cable length 20 m;</p> <p>When connecting, be sure to observe chapter "25 10-pole/ 18-pole Plugs".</p>
<i>ZUB0 KAB NMC 30</i>	<p>2-pole, pre-assembled cable with open cable ends for connection to the Connector Box; cable length 30 m;</p> <p>When connecting, be sure to observe chapter "25 10-pole/ 18-pole Plugs".</p>
<i>NFM0 ZSBL IRE</i>	<p>Hoop guards (pair), for protecting the connector plugs and fixing the Connector Box to the NFM</p>
<i>NFM0 ZHAK NFM 01</i>	<p>Suspension bracket to fasten NFM on a step iron incl. hanging bracket for sensor cable; material: stainless steel 1.4571</p>
<i>NFM0 ZHAK NFM 02</i>	<p>Suspension bracket to fasten NFM on a step iron; material: stainless steel 1.4571</p>
<i>NFM5 GUMMI PUFFER</i>	<p>Rubber buffer, set with 4 pcs.</p>

<i>NFM0 Z ANT1</i>	NFM mobile communication antenna, cable length 2.5 m, for connection to NFM with mobile remote data transmission
<i>NLM0 ANT 900 FME</i>	Rod antenna, flexible rod, length approx. 15 cm, suitable e.g. for NFMxxx (in conjunction with adapter <i>NFM0 ANT ADAP FME3</i> )
<i>NFM0 ANT ADAP FME3</i>	Antenna adapter from NIVUS NFM antenna connector to FME (M), for connecting an antenna with FME (F) connector socket, cable length 3 m, protection class IP64
<i>ZUB0 NFM SCHLOSS</i>	Padlock for transmitter in Ex version (to secure the device when used in Ex areas)
<i>ZUB0 NFM MAGNET</i>	Ring magnet for NFM/NFS, mounted
<i>BSL0 EP 220-20</i>	EnerPro 220 Tr / 20kA, mains line overvoltage protection
<i>BSL0 EP 220-5</i>	EnerPro 220 Tr / 5kA, mains line overvoltage protection
<i>BSL0 DP 2X12/12</i>	DataPro 2x1-12V/12V-11µH-Tr(N), 20,000 A leakage current, 2-wire for sensor lines
	<p>NIVUS WebPortal:</p> <p>Data management system for storage and provision of measurement data. Multiple options for direct measurement data analysis, system verification, data forwarding and alarming, right up to complete log generation through processing in the cloud. For details, please contact your sales representative.</p>
	<p>NIVUS DataKiosk / Data Kiosk Client:</p> <p>NIVUS DataKiosk is a web-based connectivity platform for the secure provision of measurement and process data to upstream or downstream systems such as a process control system. Due to its open architecture, NIVUS DataKiosk connects IoT solutions with a wide variety of IT systems and makes necessary data format adaptations.</p> <p>DataKiosk fulfils the function of a gateway. It enables application programmes to read data from a wide variety of devices and pass on control signals to devices on the basis of standardised internet technologies. Through comprehensive networking and automation, processes can be improved overall and their utility can be increased.</p> <p>The NIVUS DataKiosk Client is a graphical interface that retrieves the data from the DataKiosk and automatically stores the result in a configurable location.</p> <p>For details, please contact your sales representative.</p>

**Tab. 10 Spare Parts and Accessories**



More accessories and spare parts can be found in the current NIVUS price list.

## Index

<b>2</b>		
2G/3G/4G		
Antenna .....	49	
<b>3</b>		
3D Preview.....	92	
<b>A</b>		
Accessories.....	159	
Accident Levels.....	15	
Adhesive plates .....	22, 23, 33	
Adjustment Temperature .....	141	
Air Freight .....	22, 23	
Alarm.....	133	
Antenna.....	49	
Approvals .....	166	
Ex.....	27	
other.....	27	
Area of Use.....	30	
Article No .....	25, 26, 28, 84, 110	
Automatic Data Transmission.....	78	
<b>B</b>		
Backup Battery .....	18, 113	
Basic Menus .....	64	
Battery Type.....	35, 128	
<b>C</b>		
Cable		
Sensor Connection .....	45	
Calming Section.....	40	
Canal Dimensions.....	91	
Capacity .....	37	
Rechargeable/Battery.....	128	
Capacity Display		
Rechargeable/Battery.....	86, 128	
Certificates .....	166	
Channel Profiles .....	91	
Charger .....	13, 27, 36, 37, 39, 48, 159	
Specifications.....	27	
Charging Capacity		
Rechargeable/Battery.....	38	
Charging Status .....	110	
Charging tray .....	36, 37, 39	
Cleaning.....	17, 20, 157, 158	
Codes.....	165	
Colour Code		
Wires.....	12	
Commissioning Examples		
Clamp-On Sensors .....	65	
Wetted Sensors .....	69	
Compress.....	107	
Connectable Sensors.....	25	
Connection Setup		
Android OS .....	53	
iOS Operating System .....	56	
Windows OS .....	59	
Connection Sockets .....	34	
Connections .....	12, 20, 23	
Connector Box .....	22, 47, 160	
Continuous Mode.....	120	
Control Elements .....	13	
Copyright.....	3	
Copyrights .....	3	
Correlation		
Simulation .....	144	
Country Settings .....	87, 110, 129	
Credits.....	165	
Current Measurement Data .....	103	
Customer Centre.....	158	
Cycle Mode .....	119	
<b>D</b>		
Damping.....	93	
Data Transmission .....	27, 49	
Data Transmission, automatic .....	78	
date .....	113	
Delete Memory.....	107	
Delta t.....	140	
Device ID .....	25	
Device Structure .....	24	
Device Versions .....	28	
Diagnostics .....	102, 139	
Basics .....	139	
Inputs/Outputs .....	141	
Signal Analysis .....	143	
v-Paths.....	140	
Digital Inputs .....	99	
Digital Outputs .....	100	
Disclaimer .....	18	
Dismantling .....	159	
Display		
Overview .....	62	
Disposal .....	20, 159	
Rechargeable Battery Block .....	38	
Download .....	11, 107	
<b>E</b>		
Enclosure .....	27	
Enclosure dimensions.....	25	
Error Messages.....	64, 84, 114	

EU WEEE Directive .....	159	Modem State .....	122
Event Continuous Mode .....	120	MQTT .....	124
Event Interval .....	120	SIM Card .....	123
Event Mode .....	120	Mounting Place .....	33, 40, 94
<b>F</b>		Mounting Position	
Firmware version .....	110	Sensors .....	94
<b>G</b>		<b>N</b>	
Gaskets		Nameplate .....	19, 25
On The Enclosure Cover .....	33	Names .....	3
Germs .....	17, 157	National Language .....	3, 111
<b>H</b>		NIVUS Addresses .....	2
Hoop guards .....	22	Noise	
Hotline .....	51	Simulation .....	145
Humidity .....	27	Notes on Use .....	51
<b>I</b>		<b>O</b>	
Inner Lining		Operation Mode .....	79, 119, 130
Pipeline .....	65, 92	Operation Temperature .....	27
Inputs/Outputs		Operator's Duties .....	20
Connector Box .....	47	Original Instruction Manual .....	3
Single external Connection .....	46	Overview .....	24
Inspection upon Receipt .....	22	Overvoltage Protection Measures .....	46
Installation .....	33	<b>P</b>	
Clamp-On Sensors .....	40	Parameter Reset .....	116
Wetted Sensors .....	42	Path Arrangement .....	41
Intended Use .....	19	Clamp-On .....	89
Interface		Diametral .....	41
Communication .....	64	Diametral V .....	41
Mobile Phone .....	49, 50	Diametral W .....	41
USB .....	12, 19, 24, 78, 106	Wetted .....	90
Interfaces .....	14	Pipe Material .....	31, 92
<b>L</b>		Power Adapter .....	36, 37, 39, 48, 159
Licences .....	165	Power Failure .....	113
Licensing Issues .....	165	Power Supply .....	27
Load Parameters .....	108	Powerdown .....	115
Low-flow suppression .....	92	Precautions, special .....	17
<b>M</b>		Product Construction .....	24
Main Screen .....	70	Product Disposal .....	20
Maintenance Interval .....	157	Property Rights .....	3
Materials Disposal .....	20	Protection .....	27, 34, 158
Maximum Measurement Duration .....	93	Protective earth connection .....	16
Measurement Medium .....	89, 90, 92	PUK .....	54, 57, 60, 77, 123
Measurement Principle .....	27	<b>Q</b>	
Medium Temperature .....	62, 89, 91, 98	Q suppressed .....	92
Minimum Measurement Duration .....	93	Qualified Personnel .....	21
Mobile .....	122	Quick Start .....	64, 86, 129
DNS .....	124	Procedure .....	78
E-Mail .....	125	<b>R</b>	
FTP .....	125	Rechargeable Battery Life .....	38
		Rechargeable Battery Type .....	128



<p>Remote Data Transmission .....28</p> <p>Repeated measurement of the same measurement places.....76</p> <p>Restart ..... 115</p> <p>Return .....23</p> <p>Rubber buffers .....23, 47, 160</p> <p><b>S</b></p> <p>Safety Instructions .....15, 139, 142</p> <p>Safety Measures .....17</p> <p>Save Parameters .....108</p> <p>Saving Data to USB.....107</p> <p>Scope of Delivery.....22</p> <p>Search Scan</p> <p style="padding-left: 20px;">Simulation .....143</p> <p>Sediments .....92</p> <p>Sensor Test</p> <p style="padding-left: 20px;">Simulation .....146</p> <p>Sensor Types.....40</p> <p>serial number ..... 25, 26, 40, 54, 57, 60, 77</p> <p>Serial number .....84</p> <p>Service Level .....115</p> <p>Service Levels .....115</p> <p>Signal analysis</p> <p style="padding-left: 20px;">Simulation .....143</p> <p>Signal Scan</p> <p style="padding-left: 20px;">Simulation .....143</p> <p>Signal Scan Envelope</p> <p style="padding-left: 20px;">Simulation .....144</p> <p>Signal strength .....122, 131</p> <p>Signal words, used .....15</p> <p>Simulation .....147</p> <p style="padding-left: 20px;">Important Information .....141</p> <p>Slot For Rechargeable Battery Block</p> <p style="padding-left: 20px;">Battery Mode .....35, 39, 40</p> <p style="padding-left: 20px;">Charging .....39</p> <p style="padding-left: 20px;">Charging Mode .....35, 39, 40</p> <p>Spare Parts .....159, 161</p> <p>Specifications.....27</p> <p>SSID.....77</p> <p>Stability .....93</p> <p>Storage .....22</p> <p>Storage Cycle .....27, 120</p> <p>Storage Temperature, Permanent.....27</p> <p>Subsidiaries .....2</p> <p>Super PIN .....77</p> <p>Symbols, used .....15</p> <p>System Time.....113</p> <p>System Times .....93</p> <p><b>T</b></p> <p>Temperature Adjustment .....141</p> <p>Time Changeover .....113</p>	<p>Totalising.....104</p> <p>Transit t .....140</p> <p>Transit Time Difference</p> <p style="padding-left: 20px;">Determination .....31</p> <p style="padding-left: 20px;">Measurement Method..... 30, 31, 40</p> <p style="padding-left: 20px;">Principle .....30</p> <p>Translation .....3</p> <p>Transmission Signal</p> <p style="padding-left: 20px;">Simulation .....144</p> <p>Transport.....23</p> <p>Troubleshooting</p> <p style="padding-left: 20px;">Causes .....148</p> <p style="padding-left: 20px;">Messages.....148</p> <p style="padding-left: 20px;">Remedies.....148</p> <p><b>U</b></p> <p>USB Stick..... 78, 106</p> <p>Use</p> <p style="padding-left: 20px;">In Flood-Prone Areas.....34</p> <p>UTC World Time .....113</p> <p><b>V</b></p> <p>v suppressed.....93</p> <p>v-Maximum, Mounting Position.....95</p> <p>v-Minimum, Mounting Position.....95</p> <p><b>W</b></p> <p>Wake-Up</p> <p style="padding-left: 20px;">Android.....53</p> <p style="padding-left: 20px;">iOS .....56</p> <p style="padding-left: 20px;">Windows .....60</p> <p>Warning Notice on the Device .....16</p> <p>Wearing Parts .....159</p> <p>Weighting .....94</p> <p>Wires</p> <p style="padding-left: 20px;">Colour Code.....12</p> <p>WLAN.....121</p> <p>WLAN Password.....76</p> <p>World Time UTC .....113</p> <p><b>Z</b></p> <p>Zero Point Adjustment .....141</p>
---	--



## Credits and Licenses

### 61 List of Sources of the Licences and Codes used

The transmitter type NivuFlow Mobile uses code from the following open source projects:

- Freetype (<http://www.freetype.org>)
- Libharu (<http://libharu.org>)
- Libjpeg (<http://www.ijg.org>)
- Libpng (<http://www.libpng.org>)
- Zlib (<http://www.zlib.net>)
- Mini-XML (<http://www.msweet.org>)
- Nano-X/nxlib (<http://www.microwindows.org>)
- FLTK (<http://www.fltk.org>)
- Appendix1: LGPL
- Appendix2: MPL



#### **Licensing Issues**

*For questions on licensing contact [opensource@nivus.com](mailto:opensource@nivus.com)*

---

## Approvals and Certificates

DE / EN / FR											
		<p><b>EU Konformitätserklärung</b></p> <p><i>EU Declaration of Conformity</i></p> <p><i>Déclaration de conformité UE</i></p> <p>Für das folgend bezeichnete Erzeugnis: <i>For the following product:</i> <i>Le produit désigné ci-dessous:</i></p>	<p>NIVUS GmbH Im Täle 2 75031 Eppingen</p> <p>Telefon: +49 07262 9191-0 Telefax: +49 07262 9191-999 E-Mail: info@nivus.com Internet: www.nivus.de</p>								
		<table border="0" style="width: 100%;"> <tr> <td style="width: 20%;"><b>Bezeichnung:</b></td> <td><b>Portabler Durchflussmessumformer/-datenlogger, Standardausführung NivuFlow Mobile / NivuLevel Mobile</b></td> </tr> <tr> <td><i>Description:</i></td> <td><i>Portable flow measurement transmitter/data logger, standard version NivuFlow Mobile / NivuLevel Mobile</i></td> </tr> <tr> <td><i>Désignation:</i></td> <td><i>Débitmètre/enregistreur de données portable, version standard NivuFlow Mobile / NivuLevel Mobile</i></td> </tr> <tr> <td><b>Typ / Type:</b></td> <td><b>NFM0xxx00 00</b></td> </tr> </table>	<b>Bezeichnung:</b>	<b>Portabler Durchflussmessumformer/-datenlogger, Standardausführung NivuFlow Mobile / NivuLevel Mobile</b>	<i>Description:</i>	<i>Portable flow measurement transmitter/data logger, standard version NivuFlow Mobile / NivuLevel Mobile</i>	<i>Désignation:</i>	<i>Débitmètre/enregistreur de données portable, version standard NivuFlow Mobile / NivuLevel Mobile</i>	<b>Typ / Type:</b>	<b>NFM0xxx00 00</b>	
<b>Bezeichnung:</b>	<b>Portabler Durchflussmessumformer/-datenlogger, Standardausführung NivuFlow Mobile / NivuLevel Mobile</b>										
<i>Description:</i>	<i>Portable flow measurement transmitter/data logger, standard version NivuFlow Mobile / NivuLevel Mobile</i>										
<i>Désignation:</i>	<i>Débitmètre/enregistreur de données portable, version standard NivuFlow Mobile / NivuLevel Mobile</i>										
<b>Typ / Type:</b>	<b>NFM0xxx00 00</b>										
		<p>erklären wir in alleiniger Verantwortung, dass die auf dem Unionsmarkt ab dem Zeitpunkt der Unterzeichnung bereitgestellten Geräte die folgenden einschlägigen Harmonisierungsvorschriften der Union erfüllen:</p> <p><i>we declare under our sole responsibility that the equipment made available on the Union market as of the date of signature of this document meets the standards of the following applicable Union harmonisation legislation:</i></p> <p><i>nous déclarons, sous notre seule responsabilité, à la date de la présente signature, la conformité du produit pour le marché de l'Union, aux directives d'harmonisation de la législation au sein de l'Union:</i></p> <ul style="list-style-type: none"> <li>• 2014/53/EU</li> <li>• 2011/65/EU</li> </ul> <p>Bei der Bewertung wurden folgende einschlägige harmonisierte Normen zugrunde gelegt bzw. wird die Konformität erklärt in Bezug auf die nachfolgend genannten anderen technischen Spezifikationen:</p> <p><i>The evaluation assessed the following applicable harmonised standards or the conformity is declared in relation to other technical specifications listed below:</i></p> <p><i>L'évaluation est effectuée à partir des normes harmonisées applicable ou la conformité est déclarée en relation aux autres spécifications techniques désignées ci-dessous:</i></p> <ul style="list-style-type: none"> <li>• EN 61010-1:2010 + A1:2019 + A1:2019/AC:2019</li> <li>• EN 61326-1:2013</li> <li>• ETSI EN 301 489-17 V3.2.5</li> <li>• EN 301 893 V2.1.1 (WLAN)</li> <li>• EN 62311:2008</li> <li>• ETSI EN 301 489-1 V2.2.3</li> <li>• EN 300 328 V2.2.2 (WLAN)</li> <li>• EN 300 440 V2.2.1 (WLAN)</li> </ul> <p>Diese Erklärung wird verantwortlich für den Hersteller:</p> <p><i>This declaration is submitted on behalf of the manufacturer:</i></p> <p><i>Le fabricant assume la responsabilité de cette déclaration:</i></p> <p style="margin-left: 40px;"><b>NIVUS GmbH</b> <b>Im Täle 2</b> <b>75031 Eppingen</b> <b>Germany</b></p> <p>abgegeben durch / <i>represented by / faite par:</i> <b>Ingrid Steppe</b> (Geschäftsführerin / <i>Managing Director / Directeur général</i>)</p> <p>Eppingen, den 21.10.2022</p> <p>Gez. <i>Ingrid Steppe</i></p>									



## UK Declaration of Conformity

NIVUS GmbH  
Im Täle 2  
75031 Eppingen  
Telefon: +49 07262 9191-0  
Telefax: +49 07262 9191-999  
E-Mail: info@nivus.com  
Internet: www.nivus.de

For the following product:

<b>Description:</b>	<b>Portable flow measurement transmitter/data logger, standard version NivuFlow Mobile / NivuLevel Mobile</b>
<b>Type:</b>	<b>NFM0xxx00 00</b>

we declare under our sole responsibility that the equipment made available on the UK market as of the date of signature of this document meets the standards of the following applicable UK harmonisation legislation:

- SI 2017 / 1206 The Radio Equipment Regulations 2017
- SI 2012 / 3032 The Restriction of the Use of Certain Hazardous Substances in Electrical and Electronic Equipment Regulations 2012

The evaluation assessed the following applicable harmonised standards or the conformity is declared in relation to other technical specifications listed below:

- BS EN 61010-1:2010 + A1:2019 + A1:2019/AC:2019
- BS EN 61326-1:2013
- ETSI EN 301 489-17 V3.2.5
- BS EN 301 893 V2.1.1 (WLAN)
- BS EN 62311:2008
- ETSI EN 301 489-1 V2.2.3
- BS EN 300 328 V2.2.2 (WLAN)
- BS EN 300 440 V2.2.1 (WLAN)

This declaration is submitted on behalf of the manufacturer:

**NIVUS GmbH  
Im Täle 2  
75031 Eppingen  
Germany**

represented by:

**Ingrid Steppe** (Managing Director)

Eppingen, 21/10/2022

Signed by *Ingrid Steppe*

Q:\Formulare\CE\CE\_Template\_ex\_02

DE / EN / FR

## EU Konformitätserklärung

*EU Declaration of Conformity*

*Déclaration de conformité UE*

Für das folgend bezeichnete Erzeugnis:

*For the following product:*

*Le produit désigné ci-dessous:*



NIVUS GmbH  
Im Täle 2  
75031 Eppingen

Telefon: +49 07262 9191-0  
Telefax: +49 07262 9191-999  
E-Mail: info@nivus.com  
Internet: www.nivus.de

<b>Bezeichnung:</b>	<b>"Ex" Portabler Durchflussmessumformer/-datenlogger, Standardausführung NivuFlow Mobile / NivuLevel Mobile</b>
<i>Description:</i>	<i>"Ex" Portable flow measurement transmitter/data logger, standard version NivuFlow Mobile / NivuLevel Mobile</i>
<i>Désignation:</i>	<i>"Ex" Débitmètre/enregistreur de données portable, version standard NivuFlow Mobile / NivuLevel Mobile</i>
<b>Typ / Type:</b>	<b>NFM0xxx0E 0x</b>

erklären wir in alleiniger Verantwortung, dass die auf dem Unionsmarkt ab dem Zeitpunkt der Unterzeichnung bereitgestellten Geräte die folgenden einschlägigen Harmonisierungsvorschriften der Union erfüllen:

*we declare under our sole responsibility that the equipment made available on the Union market as of the date of signature of this document meets the standards of the following applicable Union harmonisation legislation:*

*nous déclarons, sous notre seule responsabilité, à la date de la présente signature, la conformité du produit pour le marché de l'Union, aux directives d'harmonisation de la législation au sein de l'Union:*

- 2014/53/EU
- 2014/34/EU
- 2011/65/EU

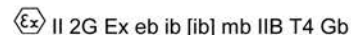
Bei der Bewertung wurden folgende einschlägige harmonisierte Normen zugrunde gelegt bzw. wird die Konformität erklärt in Bezug auf die nachfolgend genannten anderen technischen Spezifikationen:

*The evaluation assessed the following applicable harmonised standards or the conformity is declared in relation to other technical specifications listed below:*

*L'évaluation est effectuée à partir des normes harmonisées applicable ou la conformité est déclarée en relation aux autres spécifications techniques désignées ci-dessous:*

- EN 61010-1:2010 + A1:2019 + A1:2019/AC:2019
- EN 61326-1:2013
- Draft ETSI EN 301 489-17 V3.2.5
- EN 301 893 V2.1.1 (WLAN)
- EN IEC 60079-0:2018
- EN 60079-11:2012
- EN 62311:2008
- Draft ETSI EN 301 489-1 V2.2.3
- EN 300 328 V2.2.2 (WLAN)
- EN 300 440 V2.2.1 (WLAN)
- EN IEC 60079-7:2015/A1:2018
- EN 60079-18:2015/A1:2017

Ex-Kennzeichnung / *Ex-designation / Marquage Ex :*



EU-Baumusterprüfbescheinigung / *EU-Type Examination Certificate / Attestation d'examen «UE» de type:*

TÜV 17 ATEX 196722 X issue: 01

Notifizierte Stelle (Kennnummer) / *Notified Body (Identif. No.) / Organisme notifié (N° d'identification)*

TÜV NORD CERT GmbH, Am TÜV 1, 45307 Essen, Germany

(0044)

Diese Erklärung wird verantwortlich für den Hersteller:

*This declaration is submitted on behalf of the manufacturer:*

*Le fabricant assume la responsabilité de cette déclaration:*

**NIVUS GmbH**  
**Im Täle 2**  
**75031 Eppingen**  
**Germany**

abgegeben durch / *represented by / faite par:*

**Ingrid Steppe** (Geschäftsführerin / *Managing Director / Directeur général*)

Eppingen, den 21.10.2022

Gez. *Ingrid Steppe*



## UK Declaration of Conformity

NIVUS GmbH  
Im Täle 2  
75031 Eppingen  
Telefon: +49 07262 9191-0  
Telefax: +49 07262 9191-999  
E-Mail: info@nivus.com  
Internet: www.nivus.de

For the following product:

<b>Description:</b>	<b>"Ex" Portable flow measurement transmitter/data logger, standard version NivuFlow Mobile / NivuLevel Mobile</b>
<b>Type:</b>	<b>NFM0xxx0E 0x</b>

we declare under our sole responsibility that the equipment made available on the UK market as of the date of signature of this document meets the standards of the following applicable UK harmonisation legislation:

- SI 2017 / 1206 The Radio Equipment Regulations 2017
- SI 2016 / 1107 The Equipment and Protective Systems Intended for use in Potentially Explosive Atmospheres Regulations 2016
- SI 2012 / 3032 The Restriction of the Use of Certain Hazardous Substances in Electrical and Electronic Equipment Regulations 2012

The evaluation assessed the following applicable harmonised standards or the conformity is declared in relation to other technical specifications listed below:

- BS EN 61010-1:2010 + A1:2019 + A1:2019/AC:2019
- BS EN 61326-1:2013
- Draft ETSI EN 301 489-17 V3.2.5
- BS EN 301 893 V2.1.1 (WLAN)
- BS EN IEC 60079-0:2018
- BS EN 60079-11:2012
- BS EN 62311:2008
- Draft ETSI EN 301 489-1 V2.2.3
- BS EN 300 328 V2.2.2 (WLAN)
- BS EN 300 440 V2.2.1 (WLAN)
- BS EN IEC 60079-7:2015/A1:2018
- BS EN 60079-18:2015/A1:2017

Ex-designation:

⊕ I 2G Ex eb ib [ib] mb IIB T4 Gb

EU-Type Examination Certificate:

TÜV 17 ATEX 196722 X issue: 01

Notified Body (Identif. No.):

TÜV Nord CERT GmbH, Am TÜV 1, 45307 Essen, Germany

(0044)

This declaration is submitted on behalf of the manufacturer:

**NIVUS GmbH**  
**Im Täle 2**  
**75031 Eppingen**  
**Germany**

represented by:

**Ingrid Steppe** (Managing Director)

Eppingen, 21/10/2022

Signed by *Ingrid Steppe*

Q:\Formulare\CE\CE\_Template\_ex\_02



## EU Konformitätserklärung

*EU Declaration of Conformity*

*Déclaration de conformité UE*

Für das folgend bezeichnete Erzeugnis:

*For the following product:*

*Le produit désigné ci-dessous:*



NIVUS GmbH  
Im Täle 2  
75031 Eppingen

Telefon: +49 07262 9191-0  
Telefax: +49 07262 9191-999  
E-Mail: info@nivus.com  
Internet: www.nivus.de

<b>Bezeichnung:</b>	<b>Portabler Durchflussmessumformer/-datenlogger mit internem Modem zur Datenfernübertragung über GPRS/UMTS/LTE NivuFlow Mobile/NivuLevel Mobile</b>
<i>Description:</i>	<i>Portable flow measurement transmitter/data logger with internal modem for data transmission via GPRS/UMTS/LTE NivuFlow Mobile/NivuLevel Mobile</i>
<i>Désignation:</i>	<i>Débitmètre/enregistreur de données portable avec modem interne pour la transmission de données à distance via GPRS/UMTS/LTE NivuFlow Mobile/NivuLevel Mobile</i>
<b>Typ / Type:</b>	<b>NFM0xxxG0 Ex</b>

erklären wir in alleiniger Verantwortung, dass die auf dem Unionsmarkt ab dem Zeitpunkt der Unterzeichnung bereitgestellten Geräte die folgenden einschlägigen Harmonisierungsvorschriften der Union erfüllen:

*we declare under our sole responsibility that the equipment made available on the Union market as of the date of signature of this document meets the standards of the following applicable Union harmonisation legislation:*

*nous déclarons, sous notre seule responsabilité, à la date de la présente signature, la conformité du produit pour le marché de l'Union, aux directives d'harmonisation de la législation au sein de l'Union:*

- 2014/53/EU
- 2011/65/EU

Bei der Bewertung wurden folgende einschlägige harmonisierte Normen zugrunde gelegt bzw. wird die Konformität erklärt in Bezug auf die nachfolgend genannten anderen technischen Spezifikationen:

*The evaluation assessed the following applicable harmonised standards or the conformity is declared in relation to other technical specifications listed below:*

*L'évaluation est effectuée à partir des normes harmonisées applicable ou la conformité est déclarée en relation aux autres spécifications techniques désignées ci-dessous:*

- EN 61010-1:2010 + A1:2019 + A1:2019/AC:2019
- EN 61326-1:2013
- Draft ETSI EN 301 489-17 V3.2.5
- Draft ETSI EN 301 489-52 V1.2.1
- EN 301 893 V2.1.1 (WLAN)
- EN 301 511 V12.5.1 (GSM/2G)
- EN 301 908-2 V13.1.1 (UMTS/3G)
- EN 62311:2008
- EN 301 489-1 V2.2.3
- Draft ETSI EN 301 489-19 V2.2.1
- EN 300 328 V2.2.2 (WLAN)
- EN 300 440 V2.2.1 (WLAN)
- EN 301 908-1 V15.2.0 (UMTS/3G, LTE/4G)
- EN 301 908-13 V13.2.1 (LTE/4G)

Diese Erklärung wird verantwortlich für den Hersteller:

*This declaration is submitted on behalf of the manufacturer:*

*Le fabricant assume la responsabilité de cette déclaration:*

**NIVUS GmbH**  
**Im Täle 2**  
**75031 Eppingen**  
**Germany**

abgegeben durch / represented by / faite par:

**Ingrid Steppe** (Geschäftsführerin / Managing Director / Directeur général)

Eppingen, den 21.10.2022

Gez. *Ingrid Steppe*



## UK Declaration of Conformity

NIVUS GmbH  
Im Tale 2  
75031 Eppingen  
Telefon: +49 07262 9191-0  
Telefax: +49 07262 9191-999  
E-Mail: info@nivus.com  
Internet: www.nivus.de

For the following product:

<b>Description:</b>	<b>Portable flow measurement transmitter/data logger with internal modem for data transmission via GPRS/UMTS/LTE NivuFlow Mobile/NivuLevel Mobile</b>
<b>Type:</b>	<b>NFM0xxxG0 Ex</b>

we declare under our sole responsibility that the equipment made available on the UK market as of the date of signature of this document meets the standards of the following applicable UK harmonisation legislation:

- SI 2017 / 1206 The Radio Equipment Regulations 2017
- SI 2012 / 3032 The Restriction of the Use of Certain Hazardous Substances in Electrical and Electronic Equipment Regulations 2012

The evaluation assessed the following applicable harmonised standards or the conformity is declared in relation to other technical specifications listed below:

- BS EN 61010-1:2010 + A1:2019 + A1:2019/AC:2019
- BS EN 61326-1:2013
- Draft ETSI EN 301 489-17 V3.2.5
- Draft ETSI EN 301 489-52 V1.2.1
- BS EN 301 893 V2.1.1 (WLAN)
- BS EN 301 511 V12.5.1 (GSM/2G)
- BS EN 301 908-2 V13.1.1 (UMTS/3G)
- BS EN 62311:2008
- BS EN 301 489-1 V2.2.3
- Draft ETSI EN 301 489-19 V2.2.1
- BS EN 300 328 V2.2.2 (WLAN)
- BS EN 300 440 V2.2.1 (WLAN)
- BS EN 301 908-1 V15.2.0 (UMTS/3G, LTE/4G)
- BS EN 301 908-13 V13.2.1 (LTE/4G)

This declaration is submitted on behalf of the manufacturer:

**NIVUS GmbH**  
**Im Taele 2**  
**75031 Eppingen**  
**Germany**

represented by:  
**Ingrid Steppe** (Managing Director)

Eppingen, 21/10/2022

Signed by *Ingrid Steppe*

Q:\Formulare\CE\CE\_Template\_ex\_02

## EU Konformitätserklärung

*EU Declaration of Conformity*

*Déclaration de conformité UE*

Für das folgend bezeichnete Erzeugnis:

*For the following product:*

*Le produit désigné ci-dessous:*



NIVUS GmbH  
Im Täle 2  
75031 Eppingen

Telefon: +49 07262 9191-0  
Telefax: +49 07262 9191-999  
E-Mail: info@nivus.com  
Internet: www.nivus.de

<b>Bezeichnung:</b>	<b>Portabler Durchflussmessumformer/-datenlogger mit internem Modem zur Datenfernübertragung über GPRS/UMTS/LTE NivuFlow Mobile/NivuLevel Mobile</b>
<i>Description:</i>	<i>Portable flow measurement transmitter/data logger with internal modem for data transmission via GPRS/UMTS/LTE NivuFlow Mobile/NivuLevel Mobile</i>
<i>Désignation:</i>	<i>Débitmètre/enregistreur de données portable avec modem interne pour la transmission de données à distance via GPRS/UMTS/LTE NivuFlow Mobile/NivuLevel Mobile</i>
<b>Typ / Type:</b>	<b>NFM0xxxG0 Gx</b>

erklären wir in alleiniger Verantwortung, dass die auf dem Unionsmarkt ab dem Zeitpunkt der Unterzeichnung bereitgestellten Geräte die folgenden einschlägigen Harmonisierungsvorschriften der Union erfüllen:

*we declare under our sole responsibility that the equipment made available on the Union market as of the date of signature of this document meets the standards of the following applicable Union harmonisation legislation:*

*nous déclarons, sous notre seule responsabilité, à la date de la présente signature, la conformité du produit pour le marché de l'Union, aux directives d'harmonisation de la législation au sein de l'Union:*

- 2014/53/EU
- 2011/65/EU

Bei der Bewertung wurden folgende einschlägige harmonisierte Normen zugrunde gelegt bzw. wird die Konformität erklärt in Bezug auf die nachfolgend genannten anderen technischen Spezifikationen:

*The evaluation assessed the following applicable harmonised standards or the conformity is declared in relation to other technical specifications listed below:*

*L'évaluation est effectuée à partir des normes harmonisées applicable ou la conformité est déclarée en relation aux autres spécifications techniques désignées ci-dessous:*

- EN 61010-1:2010 + A1:2019 + A1:2019/AC:2019
- EN 61326-1:2013
- Draft ETSI EN 301 489-17 V3.2.5
- Draft ETSI EN 301 489-52 V1.2.1
- EN 301 893 V2.1.1 (WLAN)
- EN 301 511 V12.5.1 (GSM/2G)
- EN 301 908-2 V13.1.1 (UMTS/3G)
- EN 62311:2008
- EN 301 489-1 V2.2.3
- Draft ETSI EN 301 489-19 V2.2.1
- EN 300 328 V2.2.2 (WLAN)
- EN 300 440 V2.2.1 (WLAN)
- EN 301 908-1 V15.2.0 (UMTS/3G, LTE/4G)
- EN 301 908-13 V13.2.1 (LTE/4G)

Diese Erklärung wird verantwortlich für den Hersteller:

*This declaration is submitted on behalf of the manufacturer:*

*Le fabricant assume la responsabilité de cette déclaration:*

**NIVUS GmbH**  
**Im Täle 2**  
**75031 Eppingen**  
**Germany**

abgegeben durch / represented by / faite par:

**Ingrid Steppe** (Geschäftsführerin / Managing Director / Directeur général)

Eppingen, den 21.10.2022

Gez. *Ingrid Steppe*





## UK Declaration of Conformity

NIVUS GmbH  
Im Taele 2  
75031 Eppingen

Telefon: +49 07262 9191-0  
Telefax: +49 07262 9191-999  
E-Mail: info@nivus.com  
Internet: www.nivus.de

For the following product:

<b>Description:</b>	<b>Portable flow measurement transmitter/data logger with internal modem for data transmission via GPRS/UMTS/LTE NivuFlow Mobile/NivuLevel Mobile</b>
<b>Type:</b>	<b>NFM0xxxG0 Gx</b>

we declare under our sole responsibility that the equipment made available on the UK market as of the date of signature of this document meets the standards of the following applicable UK harmonisation legislation:

- SI 2017 / 1206 The Radio Equipment Regulations 2017
- SI 2012 / 3032 The Restriction of the Use of Certain Hazardous Substances in Electrical and Electronic Equipment Regulations 2012

The evaluation assessed the following applicable harmonised standards or the conformity is declared in relation to other technical specifications listed below:

- BS EN 61010-1:2010 + A1:2019 + A1:2019/AC:2019
- BS EN 61326-1:2013
- Draft ETSI EN 301 489-17 V3.2.5
- Draft ETSI EN 301 489-52 V1.2.1
- BS EN 301 893 V2.1.1 (WLAN)
- BS EN 301 511 V12.5.1 (GSM/2G)
- BS EN 301 908-2 V13.1.1 (UMTS/3G)
- BS EN 62311:2008
- EN 301 489-1 V2.2.3
- Draft ETSI EN 301 489-19 V2.2.1
- BS EN 300 328 V2.2.2 (WLAN)
- BS EN 300 440 V2.2.1 (WLAN)
- BS EN 301 908-1 V15.2.0 (UMTS/3G, LTE/4G)
- BS EN 301 908-13 V13.2.1 (LTE/4G)

This declaration is submitted on behalf of the manufacturer:

**NIVUS GmbH**  
**Im Taele 2**  
**75031 Eppingen**  
**Germany**

represented by:

**Ingrid Steppe** (Managing Director)

Eppingen, 21/10/2022

Signed by *Ingrid Steppe*

Q:\Formulare\CE\CE\_Template\_ex\_02

DE / EN / FR



### EU Konformitätserklärung

*EU Declaration of Conformity*

*Déclaration de conformité UE*

Für das folgend bezeichnete Erzeugnis:

*For the following product:*

*Le produit désigné ci-dessous:*

NIVUS GmbH  
Im Täle 2  
75031 Eppingen

Telefon: +49 07262 9191-0  
Telefax: +49 07262 9191-999  
E-Mail: info@nivus.com  
Internet: www.nivus.de

<b>Bezeichnung:</b>	<b>"Ex" Portabler Durchflussmessumformer/-datenlogger, mit internem Modem zur Datenfernübertragung über GPRS/UMTS/LTE NivuFlow Mobile / NivuLevel Mobile</b>
<i>Description:</i>	<i>"Ex" Portable flow measurement transmitter/data logger, with internal modem for data transmission via GPRS/UMTS/LTE NivuFlow Mobile / NivuLevel Mobile</i>
<i>Désignation:</i>	<i>"Ex" Débitmètre/enregistreur de données portable avec modem interne pour la transmission de données à distance via GPRS/UMTS/LTE NivuFlow Mobile / NivuLevel Mobile</i>
<b>Typ / Type:</b>	<b>NFM0xxGE Ex</b>

erklären wir in alleiniger Verantwortung, dass die auf dem Unionsmarkt ab dem Zeitpunkt der Unterzeichnung bereitgestellten Geräte die folgenden einschlägigen Harmonisierungsvorschriften der Union erfüllen:

*we declare under our sole responsibility that the equipment made available on the Union market as of the date of signature of this document meets the standards of the following applicable Union harmonisation legislation:*

*nous déclarons, sous notre seule responsabilité, à la date de la présente signature, la conformité du produit pour le marché de l'Union, aux directives d'harmonisation de la législation au sein de l'Union:*

- 2014/53/EU
- 2014/34/EU
- 2011/65/EU


Bei der Bewertung wurden folgende einschlägige harmonisierte Normen zugrunde gelegt bzw. wird die Konformität erklärt in Bezug auf die nachfolgend genannten anderen technischen Spezifikationen:

*The evaluation assessed the following applicable harmonised standards or the conformity is declared in relation to other technical specifications listed below:*

*L'évaluation est effectuée à partir des normes harmonisées applicables ou la conformité est déclarée en relation aux autres spécifications techniques désignées ci-dessous:*

- EN 61010-1:2010 + A1:2019 + A1:2019/AC:2019
- EN 61326-1:2013
- Draft ETSI EN 301 489-17 V3.2.5
- Draft ETSI EN 301 489-52 V1.2.1
- EN 301 893 V2.1.1 (WLAN)
- EN 301 511 V12.5.1 (GSM/2G)
- EN 301 908-2 V13.1.1 (UMTS/3G)
- EN IEC 60079-0:2018
- EN 60079-11:2012
- EN 62311:2008
- EN 301 489-1 V2.2.3
- Draft ETSI EN 301 489-19 V2.2.1
- EN 300 328 V2.2.2 (WLAN)
- EN 300 440 V2.2.1 (WLAN)
- EN 301 908-1 V15.2.0 (UMTS/3G, LTE/4G)
- EN 301 908-13 V13.2.1 (LTE/4G)
- EN IEC 60079-7:2015/A1:2018
- EN 60079-18:2015/A1:2017

Ex-Kennzeichnung / *Ex-designation / Marquage Ex :*

 II 2G Ex eb ib [ib] mb IIB T4 Gb

EU-Baumusterprüfbescheinigung / *EU-Type Examination Certificate / Attestation d'examen «UE» de type:*

TÜV 17 ATEX 196722 X issue: 01

Notifizierte Stelle (Kennnummer) / *Notified Body (Identif. No.) / Organisme notifié (N° d'identification)*

TÜV NORD CERT GmbH, Am TÜV 1, 45307 Essen, Germany

(0044)

Diese Erklärung wird verantwortlich für den Hersteller:

*This declaration is submitted on behalf of the manufacturer:*

*Le fabricant assume la responsabilité de cette déclaration:*

**NIVUS GmbH**  
**Im Täle 2**  
**75031 Eppingen**  
**Allemagne**

abgegeben durch / *represented by / faite par:*

**Ingrid Steppe** (Geschäftsführerin / *Managing Director / Directeur général*)

Eppingen, den 21.10.2022

Gez. *Ingrid Steppe*



## UK Declaration of Conformity

NIVUS GmbH  
Im Tälle 2  
75031 Eppingen  
Telefon: +49 07262 9191-0  
Telefax: +49 07262 9191-999  
E-Mail: info@nivus.com  
Internet: www.nivus.de

For the following product:

<b>Description:</b>	<b>"Ex" Portable flow measurement transmitter/data logger, with internal modem for data transmission via GPRS/UMTS/LTE NivuFlow Mobile / NivuLevel Mobile</b>
<b>Type:</b>	<b>NFM0xxxGE Ex</b>


we declare under our sole responsibility that the equipment made available on the UK market as of the date of signature of this document meets the standards of the following applicable UK harmonisation legislation:

- SI 2017 / 1206 The Radio Equipment Regulations 2017
- SI 2016 / 1107 The Equipment and Protective Systems Intended for use in Potentially Explosive Atmospheres Regulations 2016
- SI 2012 / 3032 The Restriction of the Use of Certain Hazardous Substances in Electrical and Electronic Equipment Regulations 2012

The evaluation assessed the following applicable harmonised standards or the conformity is declared in relation to other technical specifications listed below:

- BS EN 61010-1:2010 + A1:2019 + A1:2019/AC:2019
- BS EN 61326-1:2013
- Draft ETSI EN 301 489-17 V3.2.5
- Draft ETSI EN 301 489-52 V1.2.1
- BS EN 301 893 V2.1.1 (WLAN)
- BS EN 301 511 V12.5.1 (GSM/2G)
- BS EN 301 908-2 V13.1.1 (UMTS/3G)
- BS EN IEC 60079-0:2018
- BS EN 60079-11:2012
- BS EN 62311:2008
- BS EN 301 489-1 V2.2.3
- Draft ETSI EN 301 489-19 V2.2.1
- BS EN 300 328 V2.2.2 (WLAN)
- BS EN 300 440 V2.2.1 (WLAN)
- BS EN 301 908-1 V15.2.0 (UMTS/3G, LTE/4G)
- BS EN 301 908-13 V13.2.1 (LTE/4G)
- BS EN IEC 60079-7:2015/A1:2018
- BS EN 60079-18:2015/A1:2017

Ex-designation:

 II 2G Ex eb ib [ib] mb IIB T4 Gb

EU-Type Examination Certificate:

TÜV 17 ATEX 196722 X issue: 01

Notified Body (Identif. No.):

TÜV Nord CERT GmbH, Am TÜV 1, 45307 Essen, Germany

(0044)

This declaration is submitted on behalf of the manufacturer:

**NIVUS GmbH**  
**Im Tälle 2**  
**75031 Eppingen**  
**Germany**

represented by:

**Ingrid Steppe** (Managing Director)

Eppingen, 21/10/2022

Signed by *Ingrid Steppe*

Q:\Formulare\CE\CE\_Template\_ex\_02



DE / EN / FR

## EU Konformitätserklärung

*EU Declaration of Conformity*

*Déclaration de conformité UE*

Für das folgend bezeichnete Erzeugnis:

*For the following product:*

*Le produit désigné ci-dessous:*



NIVUS GmbH  
Im Täle 2  
75031 Eppingen

Telefon: +49 07262 9191-0  
Telefax: +49 07262 9191-999  
E-Mail: info@nivus.com  
Internet: www.nivus.de

<b>Bezeichnung:</b>	<b>"Ex" Portabler Durchflussmessumformer/-datenlogger, mit internem Modem zur Datenfernübertragung über GPRS/UMTS/LTE NivuFlow Mobile / NivuLevel Mobile</b>
<i>Description:</i>	<i>"Ex" Portable flow measurement transmitter/data logger, with internal modem for data transmission via GPRS/UMTS/LTE NivuFlow Mobile / NivuLevel Mobile</i>
<i>Désignation:</i>	<i>"Ex" Débitmètre/enregistreur de données portable avec modem interne pour la transmission de données à distance via GPRS/UMTS/LTE NivuFlow Mobile / NivuLevel Mobile</i>
<b>Typ / Type:</b>	<b>NFM0xxxGE Gx</b>

erklären wir in alleiniger Verantwortung, dass die auf dem Unionsmarkt ab dem Zeitpunkt der Unterzeichnung bereitgestellten Geräte die folgenden einschlägigen Harmonisierungsvorschriften der Union erfüllen:

*we declare under our sole responsibility that the equipment made available on the Union market as of the date of signature of this document meets the standards of the following applicable Union harmonisation legislation:*

*nous déclarons, sous notre seule responsabilité, à la date de la présente signature, la conformité du produit pour le marché de l'Union, aux directives d'harmonisation de la législation au sein de l'Union:*

- 2014/53/EU
- 2014/34/EU
- 2011/65/EU


Bei der Bewertung wurden folgende einschlägige harmonisierte Normen zugrunde gelegt bzw. wird die Konformität erklärt in Bezug auf die nachfolgend genannten anderen technischen Spezifikationen:

*The evaluation assessed the following applicable harmonised standards or the conformity is declared in relation to other technical specifications listed below:*

*L'évaluation est effectuée à partir des normes harmonisées applicable ou la conformité est déclarée en relation aux autres spécifications techniques désignées ci-dessous:*

- EN 61010-1:2010 + A1:2019 + A1:2019/AC:2019
- EN 61326-1:2013
- Draft ETSI EN 301 489-17 V3.2.5
- Draft ETSI EN 301 489-52 V1.2.1
- EN 301 893 V2.1.1 (WLAN)
- EN 301 511 V12.5.1 (GSM/2G)
- EN 301 908-2 V13.1.1 (UMTS/3G)
- EN IEC 60079-0:2018
- EN 60079-11:2012
- EN 62311:2008
- EN 301 489-1 V2.2.3
- Draft ETSI EN 301 489-19 V2.2.1
- EN 300 328 V2.2.2 (WLAN)
- EN 300 440 V2.2.1 (WLAN)
- EN 301 908-1 V15.2.0 (UMTS/3G, LTE/4G)
- EN 301 908-13 V13.2.1 (LTE/4G)
- EN IEC 60079-7:2015/A1:2018
- EN 60079-18:2015/A1:2017

Ex-Kennzeichnung / *Ex-designation* / *Marquage Ex* :

 II 2G Ex eb ib [ib] mb IIB T4 Gb

EU-Baumusterprüfbescheinigung / *EU-Type Examination Certificate* / *Attestation d'examen «UE» de type:*

TÜV 17 ATEX 196722 X issue: 01

Notifizierte Stelle (Kennnummer) / *Notified Body (Identif. No.) / Organisme notifié (N° d'identification)*

TÜV NORD CERT GmbH, Am TÜV 1, 45307 Essen, Germany

(0044)

Diese Erklärung wird verantwortlich für den Hersteller:

*This declaration is submitted on behalf of the manufacturer:*

*Le fabricant assume la responsabilité de cette déclaration:*

**NIVUS GmbH**  
**Im Täle 2**  
**75031 Eppingen**  
**Germany**

abgegeben durch / *represented by / faite par:*

**Ingrid Steppe** (Geschäftsführerin / *Managing Director / Directeur général*)

Eppingen, den 21.10.2022

Gez. *Ingrid Steppe*



## UK Declaration of Conformity

NIVUS GmbH  
Im Tälle 2  
75031 Eppingen  
Telefon: +49 07262 9191-0  
Telefax: +49 07262 9191-999  
E-Mail: info@nivus.com  
Internet: www.nivus.de

For the following product:

<b>Description:</b>	<b>"Ex" Portable flow measurement transmitter/data logger, with internal modem for data transmission via GPRS/UMTS/LTE NivuFlow Mobile / NivuLevel Mobile</b>
<b>Type:</b>	<b>NFM0xxxGE Gx</b>


we declare under our sole responsibility that the equipment made available on the UK market as of the date of signature of this document meets the standards of the following applicable UK harmonisation legislation:

- SI 2017 / 1206 The Radio Equipment Regulations 2017
- SI 2016 / 1107 The Equipment and Protective Systems Intended for use in Potentially Explosive Atmospheres Regulations 2016
- SI 2012 / 3032 The Restriction of the Use of Certain Hazardous Substances in Electrical and Electronic Equipment Regulations 2012

The evaluation assessed the following applicable harmonised standards or the conformity is declared in relation to other technical specifications listed below:

- BS EN 61010-1:2010 + A1:2019 + A1:2019/AC:2019
- BS EN 61326-1:2013
- Draft ETSI EN 301 489-17 V3.2.5
- Draft ETSI EN 301 489-52 V1.2.1
- BS EN 301 893 V2.1.1 (WLAN)
- BS EN 301 511 V12.5.1 (GSM/2G)
- BS EN 301 908-2 V13.1.1 (UMTS/3G)
- BS EN IEC 60079-0:2018
- BS EN 60079-11:2012
- BS EN 62311:2008
- BS EN 301 489-1 V2.2.3
- Draft ETSI EN 301 489-19 V2.2.1
- BS EN 300 328 V2.2.2 (WLAN)
- BS EN 300 440 V2.2.1 (WLAN)
- BS EN 301 908-1 V15.2.0 (UMTS/3G, LTE/4G)
- BS EN 301 908-13 V13.2.1 (LTE/4G)
- BS EN IEC 60079-7:2015/A1:2018
- BS EN 60079-18:2015/A1:2017

Ex-designation:

 II 2G Ex eb ib [ib] mb IIB T4 Gb

EU-Type Examination Certificate:

TÜV 17 ATEX 196722 X issue: 01

Notified Body (Identif. No.):

TÜV Nord CERT GmbH, Am TÜV 1, 45307 Essen, Germany

(0044)

This declaration is submitted on behalf of the manufacturer:

**NIVUS GmbH**  
**Im Tälle 2**  
**75031 Eppingen**  
**Germany**

represented by:

**Ingrid Steppe** (Managing Director)

Eppingen, 21/10/2022

Signed by *Ingrid Steppe*

Q:\Formulare\CE\CE\_Template\_ex\_02

DE / EN / FR

## EU Konformitätserklärung

*EU Declaration of Conformity*

*Déclaration de conformité UE*

Für das folgend bezeichnete Erzeugnis:

*For the following product:*

*Le produit désigné ci-dessous:*



NIVUS GmbH  
Im Täle 2  
75031 Eppingen

Telefon: +49 07262 9191-0  
Telefax: +49 07262 9191-999  
E-Mail: info@nivus.com  
Internet: www.nivus.de

<b>Bezeichnung:</b>	<b>Ladeschale NFM</b>
<i>Description:</i>	<i>charging station NFM</i>
<i>Désignation:</i>	<i>station de charge NFM</i>
<b>Typ / Type:</b>	<b>NFM02 LADESCH</b>

erklären wir in alleiniger Verantwortung, dass die auf dem Unionsmarkt ab dem Zeitpunkt der Unterzeichnung bereitgestellten Geräte die folgenden einschlägigen Harmonisierungsvorschriften der Union erfüllen:

*we declare under our sole responsibility that the equipment made available on the Union market as of the date of signature of this document meets the standards of the following applicable Union harmonisation legislation:*

*nous déclarons, sous notre seule responsabilité, à la date de la présente signature, la conformité du produit pour le marché de l'Union, aux directives d'harmonisation de la législation au sein de l'Union:*

- 2011/65/EU

Bei der Bewertung wurden folgende einschlägige harmonisierte Normen zugrunde gelegt bzw. wird die Konformität erklärt in Bezug die nachfolgend genannten anderen technischen Spezifikationen:

*The evaluation assessed the following applicable harmonised standards or the conformity is declared in relation to other technical specifications listed below:*

*L'évaluation est effectuée à partir des normes harmonisées applicables ou la conformité est déclarée en relation aux autres spécifications techniques désignées ci-dessous:*

- EN 50581:2012

Diese Erklärung wird verantwortlich für den Hersteller:

*This declaration is submitted on behalf of the manufacturer:*

*Le fabricant assume la responsabilité de cette déclaration:*

**NIVUS GmbH**  
**Im Täle 2**  
**75031 Eppingen**  
**Allemagne**

abgegeben durch / *represented by / faite par:*

**Marcus Fischer** (Geschäftsführer / *Managing Director / Directeur général*)

Eppingen, den 08.02.2018

Gez. *Marcus Fischer*



## UK Declaration of Conformity

NIVUS GmbH  
Im Täle 2  
75031 Eppingen  
Telefon: +49 07262 9191-0  
Telefax: +49 07262 9191-999  
E-Mail: info@nivus.com  
Internet: www.nivus.de

For the following product:

<b>Description:</b>	<b>Charging station NFM</b>
<b>Type:</b>	<b>NFM02 LADESCH</b>

we declare under our sole responsibility that the equipment made available on the UK market as of the date of signature of this document meets the standards of the following applicable UK harmonisation legislation:

- SI 2012 / 3032 The Restriction of the Use of Certain Hazardous Substances in Electrical and Electronic Equipment Regulations 2012

The evaluation assessed the following applicable harmonised standards or the conformity is declared in relation to other technical specifications listed below:

- BS EN 50581:2012

This declaration is submitted on behalf of the manufacturer:

**NIVUS GmbH**  
**Im Täle 2**  
**75031 Eppingen**  
**Germany**

represented by:  
**Ingrid Steppe** (Managing Director)

Eppingen, 20/10/2022

Signed by *Ingrid Steppe*

Q:\Formulare\CE\CE\_Template\_ex\_02





**Translation**

(1) **EU-Type Examination Certificate**

- (2) Equipment and protective systems intended for use in potentially explosive atmospheres, **Directive 2014/34/EU**



(3) **Certificate Number** TÜV 17 ATEX 196722 X **issue:** 01

(4) for the product: Portable Measuring Transformer  
NivuFlow Mobile Typ NFM-0xxx x E and  
NivuLevel Mobile Typ NFM-0050 x E

(5) of the manufacturer: NIVUS GmbH

(6) Address: Im Täle 2  
75031 Eppingen

Order number: 8003009451

Date of issue: 2019-10-28

- (7) The design of this product and any acceptable variation thereto are specified in the schedule to this EU-Type Examination Certificate and the documents therein referred to.

- (8) The TÜV NORD CERT GmbH, Notified Body No. 0044, in accordance with Article 17 of the Directive 2014/34/EU of the European Parliament and the Council of 26 February 2014, certifies that this product has been found to comply with the Essential Health and Safety Requirements relating to the design and construction of products intended for use in potentially explosive atmospheres given in Annex II to the Directive.  
The examination and test results are recorded in the confidential ATEX Assessment Report No. 19 203 251874.

- (9) Compliance with the Essential Health and Safety Requirements has been assured by compliance with:


EN 60079-0:2012+A11:2013    EN 60079-11:2012    EN 60079-7:2015  
EN 60079-18:2015

except in respect of those requirements listed at item 18 of the schedule.

- (10) If the sign "X" is placed after the certificate number, it indicates that the product is subject to the Specific Conditions for Use specified in the schedule to this certificate.

- (11) This EU-Type Examination Certificate relates only to the design, and construction of the specified product. Further requirements of the Directive apply to the manufacturing process and supply of this equipment. These are not covered by this certificate.

- (12) The marking of the product shall include the following:

 II 2 G Ex eb ib [ib] mb IIB T4 Gb

TÜV NORD CERT GmbH, Langemarckstraße 20, 45141 Essen, notified by the central office of the countries for safety engineering (ZLS), Ident. Nr. 0044, legal successor of the TÜV NORD CERT GmbH & Co. KG Ident. Nr. 0032

The head of the notified body

  
Rodér

Hannover office, Am TÜV 1, 30519 Hannover, Tel. +49 511 998-61455, Fax +49 511 998-61590

This certificate may only be reproduced without any change, schedule included.  
Excerpts or changes shall be allowed by the TÜV NORD CERT GmbH





(13) **SCHEDULE**

(14) **EU-Type Examination Certificate No. TÜV 17 ATEX 196722 X issue 01**

(15) Description of product

Together with the belonging sensors, the Portable Measuring Transformer NivuFlow Mobile type NFM-0xxx x E and NivuLevel Mobile type NFM-0050 x E are used for the measurement of the flow speed and the flow level in partly or fully filled pipes and channels via supersonic technology. The Portable Measuring Transformer NivuFlow Mobile/NivuLevel Mobile type NFM... is operated stationary.

The permissible ambient temperature range is -15 °C ... +50 °C.

Electrical data

Supply voltage .....  $U_n = 12 \text{ V d. c.}$   
 (Internal plug connections) Powered with max. 2 x 12 V/15Ah VRLA-Pb-batteries;

External supply circuit ..... in type of protection Intrinsic Safety Ex ib IIB  
 (X1R [Uin], Only for connection to an intrinsically safe circuit  
 X1B [GND]) Maximum values:  
 $U_i = 14.5 \text{ V}$   
 $I_i = 1.25 \text{ A}$   
 $P_i = 18.1 \text{ W}$   
 The effective internal capacitances and inductances are negligibly small.

1 wire circuit ..... in type of protection Intrinsic Safety Ex ib IIB  
 (CSM connector X10E [GND], Maximum values:  
 X10F [1 wire];  
 DSM connector X8E [GND], X8F [1 wire])  $U_o = 3.7 \text{ V}$   
 $I_o = 57.3 \text{ mA}$   
 $P_o = 53 \text{ mW}$   
 Characteristic line: linear

Ex ib	IIB		
	max. permissible external inductance	65 mH	10 mH
max. permissible external capacitance	9.4 µF	21 µF	37 µF

5 V circuit ..... in type of protection Intrinsic Safety Ex ib IIB  
 (CSM connector X10E [GND], Maximum values:  
 X10J [+5 V-Ex];  
 DSM connector  $U_o = 5.93 \text{ V}$   
 X8E [GND], X8J [+5 V-Ex])  $I_o = 91.7 \text{ mA}$   
 $P_o = 135.9 \text{ mW}$   
 Characteristic line: linear

Ex ib	IIB		
	max. permissible external inductance	1 mH	0.2 mH
max. permissible external capacitance	14 µF	23 µF	30 µF



**Schedule to EU-Type Examination Certificate No. TÜV 17 ATEX 196722 X issue 01**

RS485 interface pressure, output ..... in type of protection Intrinsic Safety Ex ib IIB  
(CSM connector X10G [- RxTx],  
X10H [+ RxTx]) Maximum values:

$U_o = 3.7 \text{ V}$   
 $I_o = 95.1 \text{ mA}$   
 $P_o = 88 \text{ mW}$   
Characteristic line: linear

Ex ib	IIB		
max. permissible external inductance	25 mH	10 mH	1 mH
max. permissible external capacitance	11 $\mu\text{F}$	18 $\mu\text{F}$	36 $\mu\text{F}$

RS485 interface pressure, input ..... in type of protection Intrinsic Safety Ex ib IIB  
(CSM connector X10G [- RxTx],  
X10H [+ RxTx]) Only for connection to an intrinsically safe circuit  
Maximum values:

$U_i = 7.21 \text{ V}$   
 $I_i = 176 \text{ mA}$   
 $P_i = 317.2 \text{ mW}$   
The effective internal capacitances and inductances  
are negligibly small.

Radar sensor supply ..... in type of protection Intrinsic Safety Ex ib IIB  
(Connector X1A, X1B) Maximum values:

$U_o = 9.87 \text{ V}$   
 $I_o = 629 \text{ mA}$   
 $P_o = 6.21 \text{ W}$   
Characteristic line: rectangular

Ex ib	IIB		
max. permissible external inductance	0.2 mH	0.1 mH	0.05 mH
max. permissible external capacitance	5 $\mu\text{F}$	8 $\mu\text{F}$	11.9 $\mu\text{F}$

RS485 interface, output ..... in type of protection Intrinsic Safety Ex ib IIB  
(Connector X1C, X1D) Maximum values:

$U_o = 3.7 \text{ V}$   
 $I_o = 95.1 \text{ mA}$   
 $P_o = 88 \text{ mW}$   
Characteristic line: linear

Ex ib	IIB		
max. permissible external inductance	25 mH	10 mH	1 mH
max. permissible external capacitance	11 $\mu\text{F}$	18 $\mu\text{F}$	36 $\mu\text{F}$



**Schedule to EU-Type Examination Certificate No. TÜV 17 ATEX 196722 X issue 01**

RS485 interface, input ..... in type of protection Intrinsic Safety Ex ib IIB  
 (Connector X1C, X1D) Only for connection to an intrinsically safe circuit  
 Maximum values:  
 $U_i = 10.21 \text{ V}$   
 $I_i = 248.8 \text{ mA}$   
 $P_i = 633.8 \text{ mW}$   
 The effective internal capacitances and inductances are negligibly small.

Analogue input no. 1 /2 ..... in type of protection Intrinsic Safety Ex ib IIB  
 (Connector X1G, X1F; X1H, X1J) Maximum values:  
 NivuLevel Mobile type NFM-0050 x E:  $U_o = 22.2 \text{ V}$   
 Connector X7C, X7E; X7B, X7D)  $I_o = 33 \text{ mA}$   
 $R = 48 \text{ } \Omega$   
 $P_o = 624 \text{ mW}$   
 Characteristic line: trapezoidal

Ex ib	IIB		
	max. permissible external inductance	20 mH	1 mH
max. permissible external capacitance	0.52 $\mu\text{F}$	0.56 $\mu\text{F}$	1 $\mu\text{F}$

Analogue input no. 3 ..... in type of protection Intrinsic Safety Ex ib IIB  
 (Connector X1K, X1M) Maximum values:  
 $U_o = 3.7 \text{ V}$   
 $I_o = <1 \text{ mA}$   
 $P_o = <1 \text{ mW}$   
 Characteristic line: linear

Ex ib	IIB		
	max. permissible external inductance	100 mH	10 mH
max. permissible external capacitance	19 $\mu\text{F}$	24 $\mu\text{F}$	38 $\mu\text{F}$

Analogue input no. 3 ..... in type of protection Intrinsic Safety Ex ib IIB  
 (Connector X1K, X1M) Only for connection to an intrinsically safe circuit  
 Maximum values:  
 $U_i = 5.53 \text{ V}$   
 $I_i = 33.5 \text{ mA}$   
 $P_i = 185.4 \text{ mW}$   
 The effective internal capacitances and inductances are negligibly small.



**Schedule to EU-Type Examination Certificate No. TÜV 17 ATEX 196722 X issue 01**

Analogue output ..... in type of protection Intrinsic Safety Ex ib IIB  
(Connector X1L, X1M) Maximum values:  
 $U_o = 15.78 \text{ V}$   
 $I_o = 177.4 \text{ mA}$   
 $P_o = 700 \text{ mW}$   
Characteristic line: linear

Ex ib	IIB		
	max. permissible external inductance	5.5 mH	1 mH
max. permissible external capacitance	1 $\mu\text{F}$	2.4 $\mu\text{F}$	2.6 $\mu\text{F}$

Digital input ..... in type of protection Intrinsic Safety Ex ib IIB  
(Connector X1N, X1P) Maximum values:  
 $U_o = 3.7 \text{ V}$   
 $I_o = < 1 \text{ mA}$   
 $P_o = < 1 \text{ mW}$   
Characteristic line: linear

Ex ib	IIB		
	max. permissible external inductance	100 mH	1 mH
max. permissible external capacitance	19 $\mu\text{F}$	38 $\mu\text{F}$	81 $\mu\text{F}$

Digital input ..... in type of protection Intrinsic Safety Ex ib IIB  
(Connector X1N, X1P) Only for connection to an intrinsically safe circuit  
Maximum values:  
 $U_i = 19.69 \text{ V}$   
 $I_i = 4.23 \text{ mA}$   
 $P_i = 83.3 \text{ mW}$   
The effective internal capacitances and inductances are negligibly small.

Piezo circuits ..... in type of protection Intrinsic Safety Ex ib IIB  
(CSM connector X10 A/B and C/D,  
DSM connector X8 A/B and C/D) Only for connection  
to the belonging sensors of the manufacturer  
Max. output energy: 146  $\mu\text{J}$

Relay output ..... in type of protection Intrinsic Safety Ex ib IIB  
(Connector X1S, X1T, X1U) Only for connection to an intrinsically safe circuit  
Maximum values:  
 $U_i = 26 \text{ V}$   
 $I_i = 100 \text{ mA}$   
 $P_i = 2.6 \text{ W}$   
The effective internal capacitances and inductances are negligibly small.





**Schedule to EU-Type Examination Certificate No. TÜV 17 ATEX 196722 X issue 01**

SIM-card circuit ..... in type of protection Intrinsic Safety Ex ib IIB  
 (SIM-CARD connector)

Maximum values:  
 $U_o = 4.5 \text{ V}$   
 $I_o = 283 \text{ mA}$   
 $P_o = 319 \text{ mW}$   
 Characteristic line: linear

Ex ib	IIB		
max. permissible external inductance	1 mH	0.1 mH	0.02 mH
max. permissible external capacitance	21 $\mu\text{F}$	51 $\mu\text{F}$	120 $\mu\text{F}$

The rules for interconnection of intrinsically safe circuits have to be observed.

(16) Drawings and documents are listed in the ATEX Assessment Report No. 19 203 251874.

(17) Specific Conditions for Use

1. Electrostatic charge has to be avoided for all housing parts and the interlock; the manual of the manufacturer has to be observed.
2. Charging of the supply batteries is only permitted outside of the explosion hazardous area with the charger of the manufacturer or with a separately certified charger (intrinsically safe charge circuit); the manual of the manufacturer has to be observed.
3. Change of the supply batteries / backup battery is only permitted outside of the explosion hazardous area.
4. Only permissible batteries according to the manufacturer's operating instructions are allowed to be used.
5. The memory stick is only permitted to be used outside of the explosion hazardous area at the USB port.
6. The change of the SIM card is only permitted outside of the explosion hazardous area. See "Electrical data" for operation in the explosion hazardous area.
7. Operation is only allowed in vertical position (plug-connectors downwards).
8. The housing has to be additionally secured by an interlock provided by the manufacturer.
9. The battery in the right-hand housing part (connections MP1/MP2) is not allowed to be connected, if the external power supply is used.
10. The connections at X8 are only permissible for use of the manufacturer for firmware-updates in the safe area.



(18) Essential Health and Safety Requirements

no additional ones



- End of Certificate -

		<b>IECEX Certificate of Conformity</b>	
<b>INTERNATIONAL ELECTROTECHNICAL COMMISSION</b> <b>IEC Certification System for Explosive Atmospheres</b> <small>for rules and details of the IECEX Scheme visit <a href="http://www.iecex.com">www.iecex.com</a></small>			
Certificate No.:	<b>IECEX TUN 18.0008X</b>	Page 1 of 4	<u>Certificate history:</u> Issue 0 (2018-07-27)
Status:	<b>Current</b>	Issue No: 1	
Date of Issue:	2019-11-13		
Applicant:	<b>NIVUS GmbH</b> Im Täle 2, 75031 Eppingen Germany		
Equipment:	<b>Portable Measuring Transformer NivuFlow Mobile type NFM-0xxx x E, NivuLevel Mobile type NFM-0050 x E</b>		
Optional accessory:			
Type of Protection:	<b>Increased safety "e", intrinsic safety "i", encapsulation "m"</b>		
Marking:	Ex eb ib [ib] mb IIB T4 Gb		
Approved for issue on behalf of the IECEX Certification Body:	<b>Christian Roder</b>		
Position:	<b>Head of the IECEX Certification Body</b>		
Signature: (for printed version)			
Date:	<b>2019-11-13</b>		
<ol style="list-style-type: none"><li>1. This certificate and schedule may only be reproduced in full.</li><li>2. This certificate is not transferable and remains the property of the issuing body.</li><li>3. The Status and authenticity of this certificate may be verified by visiting <a href="http://www.iecex.com">www.iecex.com</a> or use of this QR Code.</li></ol>			
Certificate issued by: <b>TÜV NORD CERT GmbH</b> Hanover Office Am TÜV 1, 30519 Hannover Germany			

		<h2 style="margin: 0;">IECEX Certificate of Conformity</h2>
Certificate No.:	<b>IECEX TUN 18.0008X</b>	Page 2 of 4
Date of issue:	2019-11-13	Issue No: 1
Manufacturer:	<b>NIVUS GmbH</b> Im Täle 2, 75031 Eppingen Germany	
Additional manufacturing locations:		
<p>This certificate is issued as verification that a sample(s), representative of production, was assessed and tested and found to comply with the IEC Standard list below and that the manufacturer's quality system, relating to the Ex products covered by this certificate, was assessed and found to comply with the IECEx Quality system requirements. This certificate is granted subject to the conditions as set out in IECEx Scheme Rules, IECEx 02 and Operational Documents as amended</p>		
<p><b>STANDARDS :</b>                  The equipment and any acceptable variations to it specified in the schedule of this certificate and the identified documents, was found to comply with the following standards</p>		
IEC 60079-0:2011 Edition:6.0	Explosive atmospheres - Part 0: General requirements	
IEC 60079-11:2011 Edition:6.0	Explosive atmospheres - Part 11: Equipment protection by intrinsic safety "i"	
IEC 60079-18:2014 Edition:4.0	Explosive atmospheres – Part 18: Equipment protection by encapsulation "m"	
IEC 60079-7:2015 Edition:5.0	Explosive atmospheres – Part 7: Equipment protection by increased safety "e"	
<p>This Certificate <b>does not</b> indicate compliance with safety and performance requirements other than those expressly included in the Standards listed above.</p>		
<p><b>TEST &amp; ASSESSMENT REPORTS:</b>                  A sample(s) of the equipment listed has successfully met the examination and test requirements as recorded in:</p>		
<p>Test Report:  <a href="#">DE/TUN/EXTR18.0013/00</a></p>		
<p>Quality Assessment Report:  <a href="#">DE/TUN/QAR13.0011/06</a></p>		

		<h2>IECEX Certificate of Conformity</h2>
Certificate No.:	<b>IECEX TUN 18.0008X</b>	Page 3 of 4
Date of issue:	2019-11-13	Issue No: 1
<b>EQUIPMENT:</b> Equipment and systems covered by this Certificate are as follows:		
Together with the belonging sensors, the "Portable Measuring Transformer"		
NivuFlow Mobile type NFM-0xxx x E and		
NivuLevel Mobile type NFM-0050 x E		
are used for the measurement of the flow speed and the flow level in partly or fully filled pipes and channels via supersonic technology.		
The Portable Measuring Transformer type NivuFlow Mobile NFM is operated stationary.		
The permissible ambient temperature range is -15 °C ... +50 °C.		
For further information, see attachment.		
<b>SPECIFIC CONDITIONS OF USE: YES as shown below:</b>		
<ol style="list-style-type: none"><li>1. Electrostatic charge has to be avoided for all housing parts and the interlock; the manual of the manufacturer has to be observed.</li><li>2. Charging of the supply batteries is only permitted outside of the explosion hazardous area with the charger of the manufacturer or with a separately certified charger (intrinsically safe charge circuit); the manual of the manufacturer has to be observed.</li><li>3. Change of the supply batteries / backup battery is only permitted outside of the explosion hazardous area.</li><li>4. Only permissible batteries according to the manufacturer's operating instructions are allowed to be used.</li><li>5. The memory stick is only permitted to be used outside of the explosion hazardous area at the USB port.</li><li>6. The change of the SIM card is only permitted outside of the explosion hazardous area. See "Electrical data" for operation in the explosion hazardous area.</li><li>7. Operation is only allowed in vertical position (plug-connectors downwards).</li><li>8. The housing has to be additionally secured by an interlock provided by the manufacturer.</li><li>9. The battery in the right-hand housing part (connections MP1/MP2) is not allowed to be connected, if the external power supply is used.</li><li>10. The connections at X8 are only permissible for use of the manufacturer for firmware-updates in the safe area.</li></ol>		



		<b>IECEX Certificate of Conformity</b>
Certificate No.:	<b>IECEX TUN 18.0008X</b>	Page 4 of 4
Date of issue:	2019-11-13	Issue No: 1
<b>DETAILS OF CERTIFICATE CHANGES (for issues 1 and above)</b>		
-Mechanical changes		
-Layout changes		
-Electrical data partly changed		
-Special Conditions partly changed		
-New type with less components "NivuLevel Mobile type NFM-0050 x E"		
<b>Annex:</b>		
<a href="#">Attachment_issue 1_NivuFlow Mobile.pdf</a>		

TÜV NORD CERT GmbH  
Hannover Office  
Am TÜV 1  
30519 Hannover  
Germany



Page 1 of 5  
Attachment to IECEx TUN 18.0008 X issue No.: 01

Product:

Together with the belonging sensors, the Portable Measuring Transformer NivuFlow Mobile type NFM-0xxx x E and NivuLevel Mobile type NFM-0050 x E are used for the measurement of the flow speed and the flow level in partly or fully filled pipes and channels via supersonic technology. The Portable Measuring Transformer NivuFlow Mobile/NivuLevel Mobile type NFM... is operated stationary.

The permissible ambient temperature range is -15 °C ... +50 °C.

Electrical data

Supply voltage .....  $U_n = 12 \text{ V d. c.}$   
(Internal plug connections) Powered with max. 2 x 12 V/15Ah VRLA-Pb-batteries;

External supply circuit ..... in type of protection Intrinsic Safety Ex ib IIB  
(X1R [Uin], Only for connection to an intrinsically safe circuit  
X1B [GND]) Maximum values:  
 $U_i = 14.5 \text{ V}$   
 $I_i = 1.25 \text{ A}$   
 $P_i = 18.1 \text{ W}$   
The effective internal capacitances and inductances are negligibly small.

1 wire circuit ..... in type of protection Intrinsic Safety Ex ib IIB  
(CSM connector X10E [GND], Maximum values:  
X10F [1 wire];  
DSM connector X8E [GND], X8F [1 wire])  $U_o = 3.7 \text{ V}$   
 $I_o = 57.3 \text{ mA}$   
 $P_o = 53 \text{ mW}$   
Characteristic line: linear

Ex ib	IIB		
	max. permissible external inductance	65 mH	10 mH
max. permissible external capacitance	9.4 $\mu\text{F}$	21 $\mu\text{F}$	37 $\mu\text{F}$

5 V circuit ..... in type of protection Intrinsic Safety Ex ib IIB  
(CSM connector X10E [GND], Maximum values:  
X10J [+5 V-Ex];  
DSM connector  $U_o = 5.93 \text{ V}$   
X8E [GND], X8J [+5 V-Ex])  $I_o = 91.7 \text{ mA}$   
 $P_o = 135.9 \text{ mW}$   
Characteristic line: linear

Ex ib	IIB		
	max. permissible external inductance	1 mH	0.2 mH
max. permissible external capacitance	14 $\mu\text{F}$	23 $\mu\text{F}$	30 $\mu\text{F}$

TÜV NORD CERT GmbH  
Hannover Office  
Am TÜV 1  
30519 Hannover  
Germany



Page 2 of 5  
Attachment to IECEx TUN 18.0008 X issue No.: 01

RS485 interface pressure, output ..... in type of protection Intrinsic Safety Ex ib IIB  
(CSM connector X10G [- RxTx], X10H [+ RxTx]) Maximum values:

$U_o = 3.7 \text{ V}$   
 $I_o = 95.1 \text{ mA}$   
 $P_o = 88 \text{ mW}$   
Characteristic line: linear

Ex ib	IIB		
max. permissible external inductance	25 mH	10 mH	1 mH
max. permissible external capacitance	11 $\mu\text{F}$	18 $\mu\text{F}$	36 $\mu\text{F}$

RS485 interface pressure, input ..... in type of protection Intrinsic Safety Ex ib IIB  
(CSM connector X10G [- RxTx], X10H [+ RxTx]) Only for connection to an intrinsically safe circuit  
Maximum values:

$U_i = 7.21 \text{ V}$   
 $I_i = 176 \text{ mA}$   
 $P_i = 317.2 \text{ mW}$   
The effective internal capacitances and inductances are negligibly small.

Radar sensor supply ..... in type of protection Intrinsic Safety Ex ib IIB  
(Connector X1A, X1B) Maximum values:

$U_o = 9.87 \text{ V}$   
 $I_o = 629 \text{ mA}$   
 $P_o = 6.21 \text{ W}$   
Characteristic line: rectangular

Ex ib	IIB		
max. permissible external inductance	0.2 mH	0.1 mH	0.05 mH
max. permissible external capacitance	5 $\mu\text{F}$	8 $\mu\text{F}$	11.9 $\mu\text{F}$

RS485 interface, output ..... in type of protection Intrinsic Safety Ex ib IIB  
(Connector X1C, X1D) Maximum values:

$U_o = 3.7 \text{ V}$   
 $I_o = 95.1 \text{ mA}$   
 $P_o = 88 \text{ mW}$   
Characteristic line: linear

Ex ib	IIB		
max. permissible external inductance	25 mH	10 mH	1 mH
max. permissible external capacitance	11 $\mu\text{F}$	18 $\mu\text{F}$	36 $\mu\text{F}$

TÜV NORD CERT GmbH  
Hannover Office  
Am TÜV 1  
30519 Hannover  
Germany



Page 3 of 5  
Attachment to IECEx TUN 18.0008 X Issue No.: 01

RS485 interface, input ..... in type of protection Intrinsic Safety Ex ib IIB  
(Connector X1C, X1D) Only for connection to an intrinsically safe circuit  
Maximum values:  
 $U_i = 10.21 \text{ V}$   
 $I_i = 248.8 \text{ mA}$   
 $P_i = 633.8 \text{ mW}$   
The effective internal capacitances and inductances are negligibly small.

Analogue input no. 1 /2 ..... in type of protection Intrinsic Safety Ex ib IIB  
(Connector X1G, X1F; X1H, X1J) Maximum values:  
NivuLevel Mobile type NFM-0050 x E:  $U_o = 22.2 \text{ V}$   
Connector X7C, X7E; X7B, X7D)  $I_o = 33 \text{ mA}$   
 $R = 48 \text{ } \Omega$   
 $P_o = 624 \text{ mW}$   
Characteristic line: trapezoidal

Ex ib	IIB		
max. permissible external inductance	20 mH	1 mH	0.1 mH
max. permissible external capacitance	0.52 $\mu\text{F}$	0.56 $\mu\text{F}$	1 $\mu\text{F}$

Analogue input no. 3 ..... in type of protection Intrinsic Safety Ex ib IIB  
(Connector X1K, X1M) Maximum values:  
 $U_o = 3.7 \text{ V}$   
 $I_o = <1 \text{ mA}$   
 $P_o = <1 \text{ mW}$   
Characteristic line: linear

Ex ib	IIB		
max. permissible external inductance	100 mH	10 mH	1 mH
max. permissible external capacitance	19 $\mu\text{F}$	24 $\mu\text{F}$	38 $\mu\text{F}$

Analogue input no. 3 ..... in type of protection Intrinsic Safety Ex ib IIB  
(Connector X1K, X1M) Only for connection to an intrinsically safe circuit  
Maximum values:  
 $U_i = 5.53 \text{ V}$   
 $I_i = 33.5 \text{ mA}$   
 $P_i = 185.4 \text{ mW}$   
The effective internal capacitances and inductances are negligibly small.



TÜV NORD CERT GmbH  
 Hannover Office  
 Am TÜV 1  
 30519 Hannover  
 Germany



Page 4 of 5  
 Attachment to IECEx TUN 18.0008 X Issue No.: 01

Analogue output ..... (Connector X1L, X1M)	in type of protection Intrinsic Safety Ex ib IIB Maximum values: $U_o = 15.78 \text{ V}$ $I_o = 177.4 \text{ mA}$ $P_o = 700 \text{ mW}$ Characteristic line: linear												
	<table border="1"> <thead> <tr> <th>Ex ib</th> <th colspan="3">IIB</th> </tr> </thead> <tbody> <tr> <td>max. permissible external inductance</td> <td>5.5 mH</td> <td>1 mH</td> <td>0.1 mH</td> </tr> <tr> <td>max. permissible external capacitance</td> <td>1 <math>\mu\text{F}</math></td> <td>2.4 <math>\mu\text{F}</math></td> <td>2.6 <math>\mu\text{F}</math></td> </tr> </tbody> </table>	Ex ib	IIB			max. permissible external inductance	5.5 mH	1 mH	0.1 mH	max. permissible external capacitance	1 $\mu\text{F}$	2.4 $\mu\text{F}$	2.6 $\mu\text{F}$
Ex ib	IIB												
max. permissible external inductance	5.5 mH	1 mH	0.1 mH										
max. permissible external capacitance	1 $\mu\text{F}$	2.4 $\mu\text{F}$	2.6 $\mu\text{F}$										
Digital input ..... (Connector X1N, X1P)	in type of protection Intrinsic Safety Ex ib IIB Maximum values: $U_o = 3.7 \text{ V}$ $I_o = < 1 \text{ mA}$ $P_o = < 1 \text{ mW}$ Characteristic line: linear												
	<table border="1"> <thead> <tr> <th>Ex ib</th> <th colspan="3">IIB</th> </tr> </thead> <tbody> <tr> <td>max. permissible external inductance</td> <td>100 mH</td> <td>1 mH</td> <td>0.1 mH</td> </tr> <tr> <td>max. permissible external capacitance</td> <td>19 <math>\mu\text{F}</math></td> <td>38 <math>\mu\text{F}</math></td> <td>81 <math>\mu\text{F}</math></td> </tr> </tbody> </table>	Ex ib	IIB			max. permissible external inductance	100 mH	1 mH	0.1 mH	max. permissible external capacitance	19 $\mu\text{F}$	38 $\mu\text{F}$	81 $\mu\text{F}$
Ex ib	IIB												
max. permissible external inductance	100 mH	1 mH	0.1 mH										
max. permissible external capacitance	19 $\mu\text{F}$	38 $\mu\text{F}$	81 $\mu\text{F}$										
Digital input ..... (Connector X1N, X1P)	in type of protection Intrinsic Safety Ex ib IIB Only for connection to an intrinsically safe circuit Maximum values: $U_i = 19.69 \text{ V}$ $I_i = 4.23 \text{ mA}$ $P_i = 83.3 \text{ mW}$ The effective internal capacitances and inductances are negligibly small.												
Piezo circuits ..... (CSM connector X10 A/B and C/D, DSM connector X8 A/B and C/D)	in type of protection Intrinsic Safety Ex ib IIB Only for connection to the belonging sensors of the manufacturer Max. output energy: 146 $\mu\text{J}$												
Relay output ..... (Connector X1S, X1T, X1U)	in type of protection Intrinsic Safety Ex ib IIB Only for connection to an intrinsically safe circuit Maximum values: $U_i = 26 \text{ V}$ $I_i = 100 \text{ mA}$ $P_i = 2.6 \text{ W}$ The effective internal capacitances and inductances are negligibly small.												

TÜV NORD CERT GmbH  
Hannover Office  
Am TÜV 1  
30519 Hannover  
Germany



Page 5 of 5  
Attachment to IECEx TUN 18.0008 X issue No.: 01

SIM-card circuit ..... in type of protection Intrinsic Safety Ex ib IIB (SIM-CARD connector)		Maximum values:	
		$U_o = 4.5 \text{ V}$	
		$I_o = 283 \text{ mA}$	
		$P_o = 319 \text{ mW}$	
		Characteristic line: linear	
	Ex ib	IIB	
max. permissible external inductance	1 mH	0.1 mH	0.02 mH
max. permissible external capacitance	21 $\mu\text{F}$	51 $\mu\text{F}$	120 $\mu\text{F}$

The rules for interconnection of intrinsically safe circuits have to be observed.

Special Conditions for Safe Use:

1. Electrostatic charge has to be avoided for all housing parts and the interlock; the manual of the manufacturer has to be observed.
2. Charging of the supply batteries is only permitted outside of the explosion hazardous area with the charger of the manufacturer or with a separately certified charger (intrinsically safe charge circuit); the manual of the manufacturer has to be observed.
3. Change of the supply batteries / backup battery is only permitted outside of the explosion hazardous area.
4. Only permissible batteries according to the manufacturer`s operating instructions are allowed to be used.
5. The memory stick is only permitted to be used outside of the explosion hazardous area at the USB port.
6. The change of the SIM card is only permitted outside of the explosion hazardous area. See "Electrical data" for operation in the explosion hazardous area.
7. Operation is only allowed in vertical position (plug-connectors downwards).
8. The housing has to be additionally secured by an interlock provided by the manufacturer.
9. The battery in the right-hand housing part (connections MP1/MP2) is not allowed to be connected, if the external power supply is used.
10. The connections at X8 are only permissible for use of the manufacturer for firmware-updates in the safe area.