

Technical Instructions of Doppler Sensors

(Original technical instructions – German)

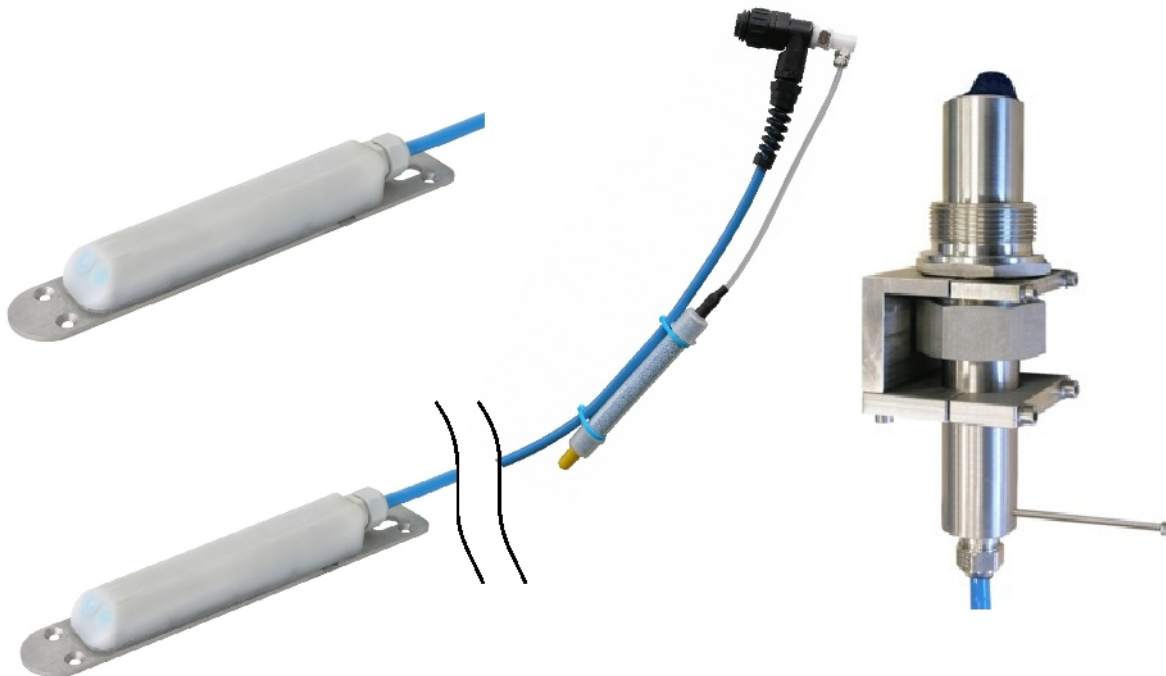

Valid as of Firmware 2.10

NIVUS GmbH

Im Taele 2

75031 Eppingen, Germany

Phone: +49(0) 72 62 91 91 - 0

Fax: +49(0) 72 62 91 91 - 999

E-mail: info@nivus.com

Internet: www.nivus.com

NIVUS AG

Hauptstrasse 49
CH - 8750 Glarus
Tel.: +41 (0)55 6452066
Fax: +41 (0)55 6452014
E-Mail: swiss@nivus.com
Internet: www.nivus.com

NIVUS Sp. z o.o.

ul. Hutnicza 3 / B-18
PL - 81-212 Gdynia
Tel.: +48 (0) 58 7602015
Fax: +48 (0) 58 7602014
E-Mail: poland@nivus.com
Internet: www.nivus.pl

NIVUS Austria

Mühlbergstraße 33B
A-3382 Loosdorf
Tel.: +43 (2754) 567 63 21
Fax: +43 (2754) 567 63 20
E-Mail: austria@nivus.com
Internet: www.nivus.com

NIVUS Middle East (FZE)

Building Q 1-1 ap. 055
P.O. Box: 9217
Sharjah Airport International
Free Zone
Tel.: +971 6 55 78 224
Fax: +971 6 55 78 225
E-Mail: Middle-East@nivus.com
Internet: www.nivus.com

NIVUS France

14, rue de la Paix
F - 67770 Sessenheim
Tel.: +33 (0)3 88071696
Fax: +33 (0)3 88071697
E-Mail: france@nivus.com
Internet: www.nivus.com

NIVUS Korea Co. Ltd.

#411 EZEN Techno Zone,
1L EB Yangchon Industrial Complex,
Gimpo-Si
Gyeonggi-Do 415-843,
Tel. +82 31 999 5920
Fax. +82 31 999 5923
E-Mail: korea@nivus.com
Internet: www.nivus.com

NIVUS U.K.

Wedgewood Rugby Road
Weston under Wetherley
Royal Leamington Spa
CV33 9BW, Warwickshire
Tel.: +44 (0)1926 632470
E-mail: info@nivus.com
Internet: www.nivus.com

NIVUS U.K.

1 Arisaig Close
Eaglescliffe
Stockton on Tees
Cleveland, TS16 9EY
Phone: +44 (0)1642 659294
E-mail: info@nivus.com
Internet: www.nivus.com

Translation

If the device is sold to a country in the European Economic Area (EEA) this instruction handbook must be translated into the language of the country in which the device is to be used.

Should the translated text be unclear, the original instruction handbook (German) must be consulted or the manufacturer contacted for clarification.

Copyright

No part of this publication may be reproduced, transmitted, sold or disclosed without prior permission. Damages will be claimed for violations. All rights reserved.

Names

The use of general descriptive names, trade names, trademarks and the like in this handbook does not entitle the reader to assume they may be used freely by everyone. They are often protected registered trademarks even if not marked as such.

1 Contents

1.1 Table of Contents

1	Contents	4
1.1	Table of Contents	4
1.2	Ex-Approval Doppler Sensors	5
2	Overview and use in accordance with the requirements	6
2.1	Overview	6
2.2	Use in accordance with the requirements	8
2.3	Specifications	9
2.3.1	Compact Doppler / combi sensor	9
2.3.2	Accessories (optional)	10
3	General Notes on Safety and Danger	11
3.1	Danger Notes	11
3.1.1	General Danger Notes	11
3.1.2	Special Danger Notes	11
3.2	Device Identification	12
3.3	Installation of Spare Parts and Parts subject to Wear and Tear	13
3.4	User's Responsibilities	13
3.5	Sensor Versions	14
4	Storing, Delivery and Transport	15
4.1	Receipt	15
4.2	Storing	15
4.3	Transport	15
4.4	Return	15
5	Installation	16
5.1	Sensor Dimensions	16
5.2	Sensor Installation	17
5.3	Plug wiring	18
5.4	Cable end configuration	18
5.5	Sensor cable	19
5.5.1	Cable extension	19
5.5.2	Pressure Compensation Element	20
6	Table of Resistiveness	25
6.1	Resistiveness Legend	27
7	Maintenance and Cleaning	28
7.1	Combi Sensor with Pressure Measurement Cell	28
7.2	Pressure Compensation Element	30
8	Dismantling/Disposal	30
9	Table of Pictures	30
10	Declaration of Conformity	31

1.2 Ex-Approval Doppler Sensors

IBExU Institut für Sicherheitstechnik GmbH
An-Institut der TU Bergakademie Freiberg

[1] **EC-TYPE EXAMINATION CERTIFICATE**
according to Directive 94/9/EC, Annex III (Translation)

[2] Equipment and Protective Systems intended for use in Potentially Explosive Atmospheres, Directive 94/9/EC

[3] EC-Type Examination Certificate Number: **IBExU07ATEX1082**

[4] Equipment: Monobloc doppler type KDA-K** E ***
KDA-R** E ***

[5] Manufacturer: NIVUS GmbH

[6] Address: Im Täle 2
75031 Eppingen
GERMANY

[7] The design of this equipment mentioned under [4] and any acceptable variation thereto are specified in the schedule to this EC-Type Examination Certificate.

[8] IBExU Institut für Sicherheitstechnik GmbH, NOTIFIED BODY number 0637 in accordance with article 9 of the Council Directive 94/9/EC of 23 March 1994, certifies that this equipment mentioned under [4] has been found to comply with the Essential Health and Safety Requirements relating to the design and construction of equipment intended for use in potentially explosive atmospheres given in Annex II to the Directive.
The test results are recorded in the test report IB-07-3-145/2 of 3rd July 2007.

[9] Compliance with the Essential Health and Safety Requirements has been assured by compliance with EN 60079-0:2004 and EN 60079-11:2007.

[10] If the sign „X“ is placed after the Certificate number, it indicates that the equipment is subject to special conditions for safe use specified under [17] in the schedule to this EC-Type Examination Certificate.

[11] This EC-Type Examination Certificate relates only to the design and construction of the specified equipment. If applicable, further requirements of this directive apply to the manufacture and supply of this equipment.

[12] The marking of the equipment mentioned under [4] shall include the following

II 2G Ex ib IIB T4

IBExU Institut für Sicherheitstechnik GmbH
Fuchsmühlenweg 7 - 09599 Freiberg, Germany
☎ +49 (0) 3731 3805-0 - 📠 +49 (0) 3731 23650

Authorised for certifications
-Explosion protection-By order

By order

(Dr. Lösch)

Schedule

- Seal -
(ID no. 0637)

Freiberg, 4th July 2007

Certificates without signature and seal are not valid. Certificates may only be duplicated completely and unchanged. In case of dispute, the German text shall prevail.

Page 1 of 2
IBExU07ATEX1082



The approval is only valid in connection with the respective indication on the sensor nameplate.

The complete EC-Type Examination Certificate is available on the Internet at www.nivus.com.

2 Overview and use in accordance with the requirements

2.1 Overview

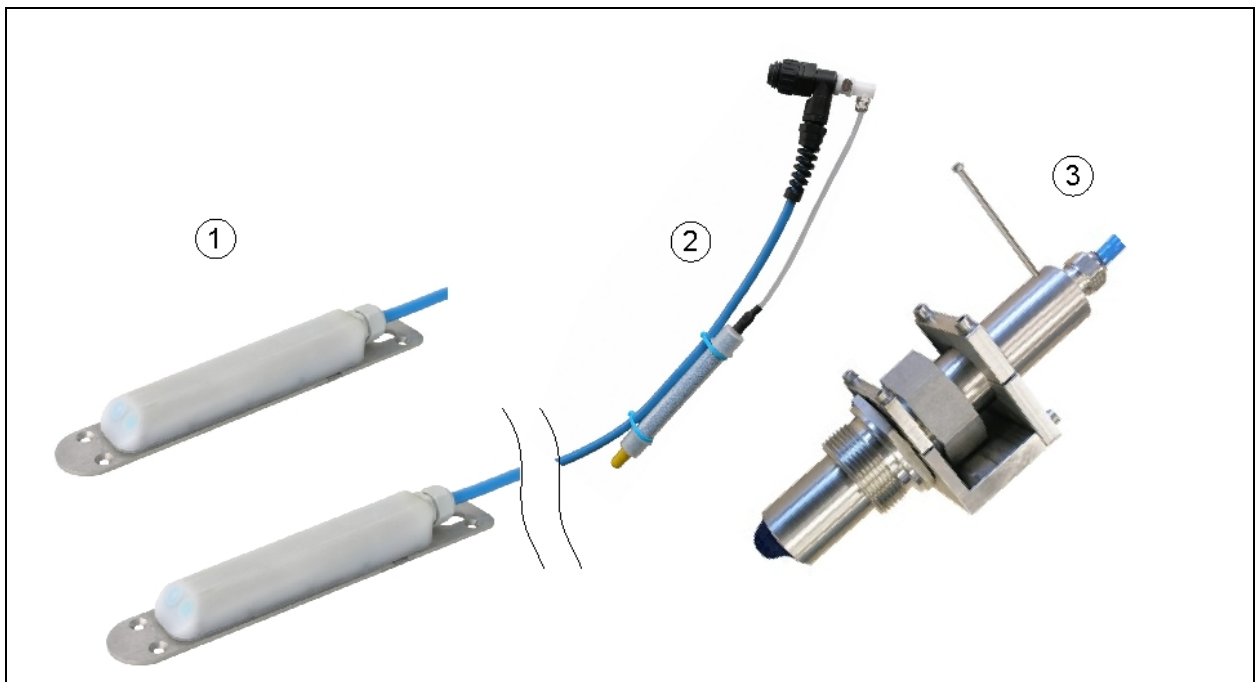

- 1 Compact Doppler wedge sensor for connection to the measurement device, type OCM F
- 2 Compact Doppler wedge sensor with Plug for connection to the measurement device, type PCM F
- 3 Compact Doppler pipe sensor with retaining element and installation help

Fig. 2-1 Sensor Overview

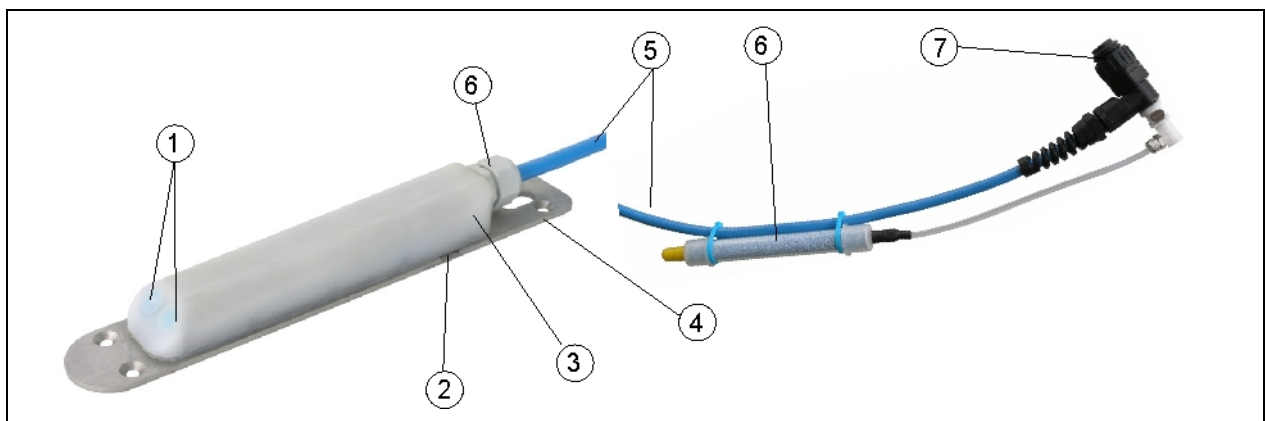

- 1 Sensor for flow velocity measurement
- 2 Sensor for level measurement using pressure (optional)
- 3 Sensor body
- 4 Ground plate
- 5 Sensor cable
- 6 Cable Gland
- 7 Plug with union nut, IP68; (optional)
- 8 Air filter (optionally fixed with plug)

Fig. 2-2 Overview wedge sensor

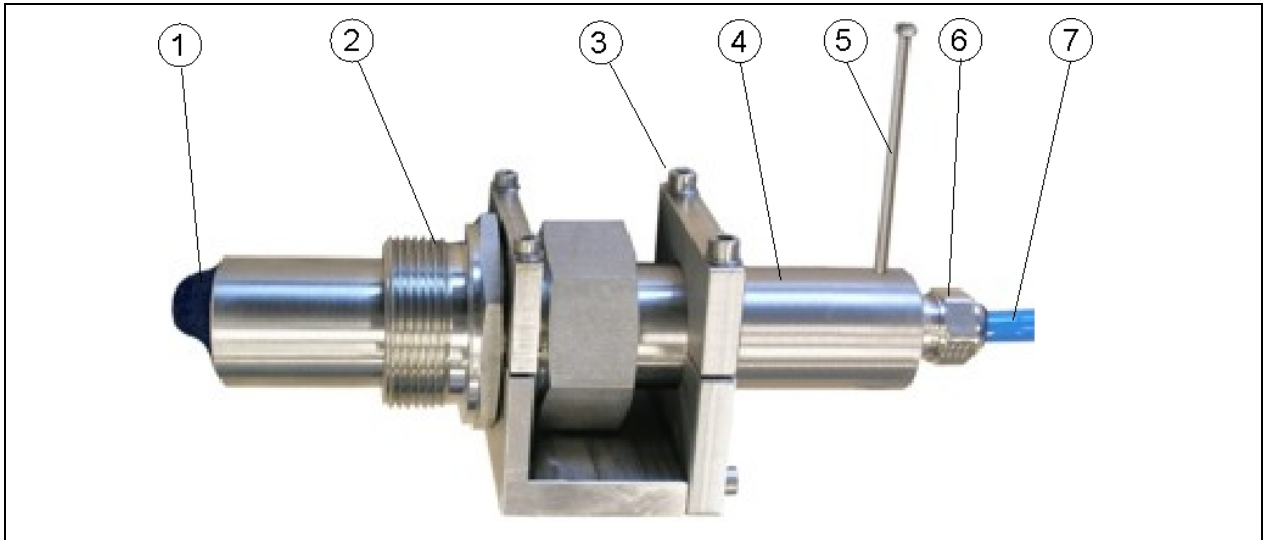

- 1 Sensor for level measurement
- 2 Sensor screw joint (movable)
- 3 Retaining element
- 4 Sensor body
- 5 Installation help, screw M4
- 6 Cable Gland
- 7 Sensor cable

Fig. 2-3 Overview Pipe Sensor

2.2 Use in accordance with the requirements

The sensor, type KDA is designed to measure flow of slight to heavy polluted media in part filled and full sewers, pipes and other channels. Depending on sensor version level measurement is additionally possible.

Please necessarily observe the maximum permissible limit values as specified in chapter 2.3. Any cases varying from these conditions without being approved by NIVUS GmbH in writing are entirely at owner's risk.



The sensors are exclusively intended to be used for purposes as described above. Modifying or using the sensors for other purposes without the written consent of the manufacturer will not be considered as use in accordance with the requirements.

Damages resulting from this are left at user's risk.

The sensors are designed for a lifetime of approx. 10 years. After that period an inspection in addition with a general overhaul has to be made.

Ex-Approval

The Ex-version of the sensors is designed to be used in areas with explosive atmospheres (zone 1).

Approval

 II 2 G Ex ib IIB T4



The approval is only valid in connection with the respective indication on the sensors nameplate.

2.3 Specifications

2.3.1 Compact Doppler / combi sensor

Measurement principle	<ul style="list-style-type: none"> - Doppler (flow velocity) - piezo-resistive pressure measurement (level)
Measurement frequency	Wedge sensors 1 MHz, pipe sensors 750 kHz
Protection	IP 68
Ex-Approval (optional)	II 2 G Ex ib IIB T4
Operating temperature	<ul style="list-style-type: none"> -20 °C to +50 °C (-4 °F to 122 °F) -20 °C to +40 °C (-4 °F to 104 °F) for applications in Ex Zone 1
Storage temperature	-30 °C to +70 °C (-22 °F to 158 °F)
Operating pressure	max. 4 bar (combi sensor with pressure element max. 1 bar)
Cable length	10/15/20/30/50/100 m pre-configured, extendable upon request; using sensors with integrated pressure measurement cell requires to use a pressure compensation element after a cable length of 30 m (99 ft).
Type of cable	<ul style="list-style-type: none"> - Combi sensors with pressure measurement: LiYC11Y 2x1,5 + 1 x 2 x 0,34 + PA 1,5/2,5 - Sensors without pressure measurement: LiYC11Y 2 x 1,5 + 1 x 2 x 0,34
Outside cable diameter	<ul style="list-style-type: none"> - Combi sensors with pressure measurement: 9,75 mm ±0,25 mm - Sensors without pressure measurement: 8,4 mm ±0,25 mm
Sensor Connection	<ul style="list-style-type: none"> - Cable end, pre-configured for connection to the measurement device, type OCM F / FR, type of cable „K“ or „L“ - Cable with Plug for connection to the measurement device, type PCM F for sensors without pressure measurement, type of cable “S” - Cable with plug and exchangeable filter element for connection to the measurement device, type PCM F, for sensors with pressure measurement, type of cable “F”
Sensor types	<ul style="list-style-type: none"> - Flow velocity sensor with v-measurement using Doppler method and temperature measurement to compensate the temperature effect on the velocity of sound. - Combi sensor with v-measurement using Doppler method; level measurement via pressure and temperature measurement to compensate the temperature effect on the velocity of sound (wedge sensor only).
Types of construction	<ul style="list-style-type: none"> - Wedge sensor for installation on channel bottom - Pipe sensor for installation in pipes with nozzle, sensor screw joint and retaining element
Medium contacting materials	<ul style="list-style-type: none"> - PVDF (wedge sensor body) - stainless steel 1.4571; V4A (mounting plate or pipe sensor body) - Polyurethane (cable sheath, screw joint and pipe sensor head) <p>Additional for sensors with pressure measurement cell:</p> <ul style="list-style-type: none"> - Hastelloy® C276 (Pressure measurement cell) - Viton; PA/PR (Gasket) <p>Option:</p> <ul style="list-style-type: none"> - FEP coated cable (only for sensors without pressure measurement)

Flow velocity measurement	
Measurement range	-600 cm/s to +600 cm/s (-3.28 fps to 19.7 fps)
Measurement uncertainty	±1 % of final value
Zero point drift	absolutely stable zero point
Sonic beam angle	±5 degrees
Temperature measurement	
Measurement range	-20 °C to +60 °C (-4 °F to 140 °F)
Measurement uncertainty	±0.5 K
Level measurement - pressure	
Measurement range	0 to 350 cm (0 to 11.5 ft)
Zero point drift	max. 0.75 % of final value (0 – 50 °C (32 °F to 122 °F))
Measurement uncertainty (standing medium)	≤0.5 % of final value

2.3.2 Accessories (optional)

Pressure compensation element	For connection of sensors with integrated pressure measurement cell Material: aluminium, plastics Protection rating: IP54 (filter element excluded)
Pipe mounting system	for temporary, non-permanent clamping installation of wedge sensors and ultrasonic level sensor in pipes DN 200 – 800 Material: 1.4571
Retractable fitting	For manually removal of 1 ½" pipe sensors under process conditions. 150 mm retractable length Material: duralumin; brass
Stop ball valve	For removal of pipe sensors from pipes without pressure Material: stainless steel 1.4408/1.4401
Tapping saddle	for installation of 1.5" pipe sensors in pipe lines Material: stainless steel 1.4301; NBR (acrylnitrile butadiene rubber)
Replacement filter	plug and connection hose for connecting the sensors to the integrated pressure measurement cell. For connection of sensors with integrated pressure measurement cell

3 General Notes on Safety and Danger

3.1 Danger Notes

3.1.1 General Danger Notes



Cautions

are framed and labelled with a warning triangle.



Notes

are framed and labelled with a "hand".



Danger by electric voltage

is framed and labelled with the Symbol on the left.



Warnings

are framed and labelled with a "STOP"-sign.

For connection, initial start-up and operation of the sensors s the following information and higher legal regulations (e.g. in Germany VDE), such as Ex-regulations as well as safety requirements and regulations in order to avoid accidents, must be adhered to.

All operations, which go beyond steps regarding installation and connection the sensors are allowed to be carried out by NIVUS staff only due to reasons of safety and guarantee.

3.1.2 Special Danger Notes



Please note that due to the operation in the waste water field sensors and cables may be loaded with hazardous disease germs. Respective precautionary measures must be taken to avoid damage to one's health.

3.2 Device Identification

The instructions in this manual apply only for the type of sensor indicated on the title page.

The article number can be found where the cable enters the sensor body as well as on a nameplate on the end of the cable. This nameplate is protected against weathering and abrasion by using a transparent shrunk-on hose and contains the following:

- name and address of manufacturer
- CE label
- type and serial number
- year of manufacture
- Ex-label (on Ex-version devices only) as mentioned in chapter 2.2.

It is important for enquiries and replacement part orders to specify article number as well as serial number of the respective transmitter or sensor. This ensures correct and quick processing.



Fig. 3-1 Nameplate flow velocity sensor wedge and pipe

3.3 Installation of Spare Parts and Parts subject to Wear and Tear

We herewith particularly emphasize that replacement parts or accessories, which are not supplied by us, are not certified by us, too. Hence, the installation and/or the use of such products may possibly be detrimental to the device's ability to work.

Damages caused by using non-original parts and non-original accessories are left at user's risk.

3.4 User's Responsibilities



In the EEA (European Economic Area) national implementation of the framework directive 89/391/EEC and corresponding individual directives, in particular the directive 89/655/EEC concerning the minimum safety and health requirements for the use of work equipment by workers at work, as amended, are to be observed and adhered to.

In Germany the Industrial Safety Ordinance must be observed.

The customer must (where necessary) obtain any local **operating permits** required and observe the provisions contained therein. In addition to this, he must observe local laws and regulations on

- personnel safety (accident prevention regulations)
- safety of work materials and tools (safety equipment and maintenance)
- disposal of products (laws on wastes)
- disposal of materials (laws on wastes)
- cleaning (cleansing agents and disposal)
- environmental protection.

3.5 Sensor Versions

The sensors are available in various constructions (wedge and pipe sensors) and additionally vary in terms of Ex-Version, cable lengths, sensor connection (cable end for direct connection or configured plug / plug-on filter element) as well as various special versions and materials.

The article number can be found where the cable enters the sensor body as well as on a nameplate on the end of the cable.. This nameplate is protected against weathering and abrasion by using a transparent shrunk-on hose.

KDA	Compact Doppler active
	Construction
K010	Wedge sensor for fastening on channel bottom or by using the RMS2 pipe mounting system
KP10	Combi wedge sensor with integrated pressure measurement cell, suitable for simultaneous flow velocity and level measurement. For installation on channel bottom or for fastening using the RMS 2 pipe mounting system.
R007	Pipe sensor for installation with G1½" screw thread
	Approvals
0	none
E	Ex Zone 1 (only for OCM F)
	Cable Length (max. 150 m / with pressure sensor up to 30 m possible)
10	10 m
15	15 m
20	20 m
30	30 m
50	50 m
99	100 m
XX	Special cable lengths upon request
	Sensor Connection
K	Cable end, pre-configured, for Types K0 and R0
L	Cable end, pre-configured, for Type KP
S	Connection to PCM F for Types K0 and R0, incl. plug
F	Connection to PCM F for Type KP, incl. plug and exchangeable filter element
	Pipe Length
0	(only for wedge sensor)
2	20 cm (standard)
3	30 cm (minimum length for stop valve)
4	40 cm (minimum length for Retractable fitting) (Only for OCMF)
X	Special pipe length in dm, price per dm
G	20 cm + extension thread
KDA-	

Fig. 3-2 Type key for KDA sensors

4 Storing, Delivery and Transport

4.1 Receipt

Please check your delivery if it is complete and in working order according to the delivery note immediately after receipt. Any damage resulting from transport or transit shall be reported to the carrier instantly. An immediate, written report must be sent to NIVUS GmbH Eppingen as well.

Please report any shortcoming due to delivery to your representative or directly to NIVUS Eppingen within two weeks in writing.



Mistakes cannot be rectified later!

4.2 Storing

The following storing conditions shall be strictly adhered to:

- max. temperature: +70° C (158° F)
- min. temperature: - 30° C (-22° F)
- max. humidity: 100 %

The Sensors shall be protected from corrosive or organic solvent vapours, radioactive radiation as well as strong electromagnetic radiation.

4.3 Transport

The Sensors are designed for harsh industrial conditions. However do not expose them to heavy shocks or vibrations.

Transportation must be carried out in the original packaging.

4.4 Return

The units must be returned at customer costs to NIVUS Eppingen in the original packaging.

Otherwise the return cannot be accepted!

5 Installation

5.1 Sensor Dimensions

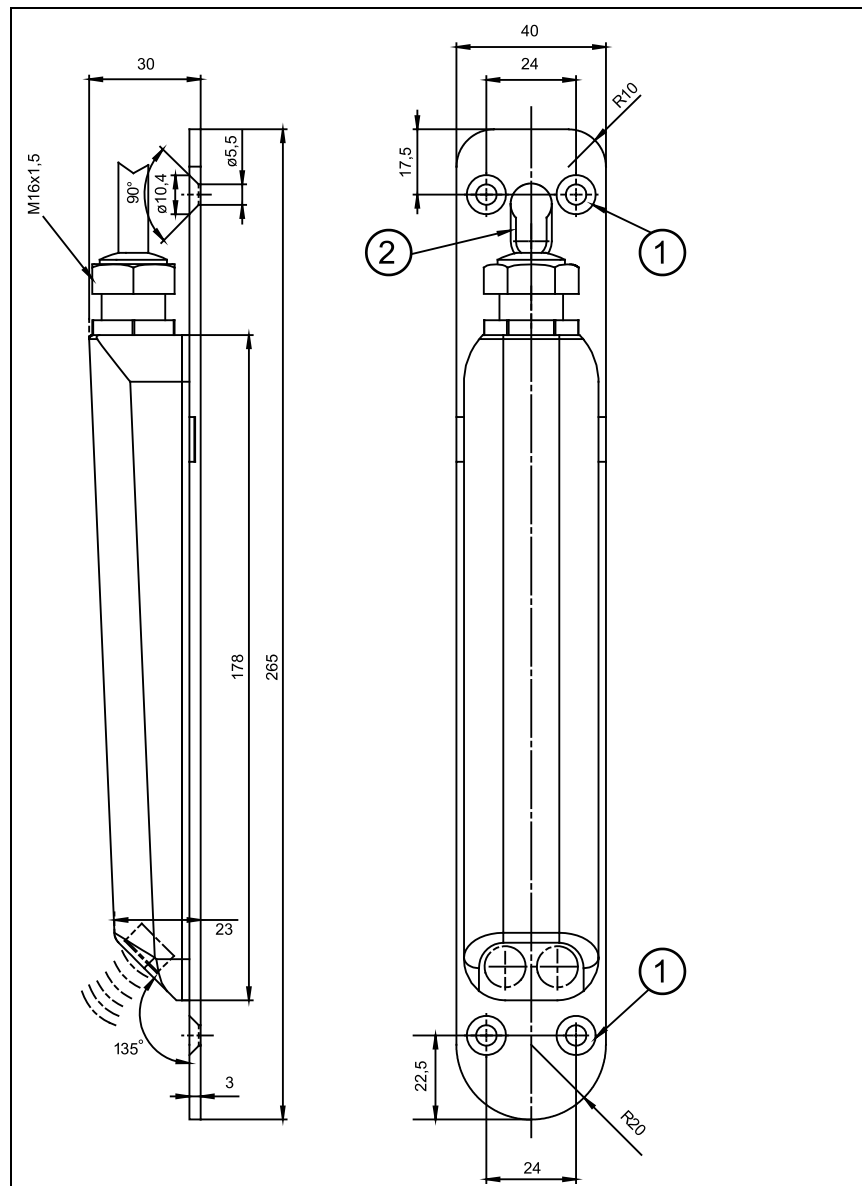

1 = Countersunk holes according to DIN 66-5 for direct fastening

2 = Slotted holes for fastening on pipe mounting system

Fig. 5-1 Dimensions KDA wedge sensor

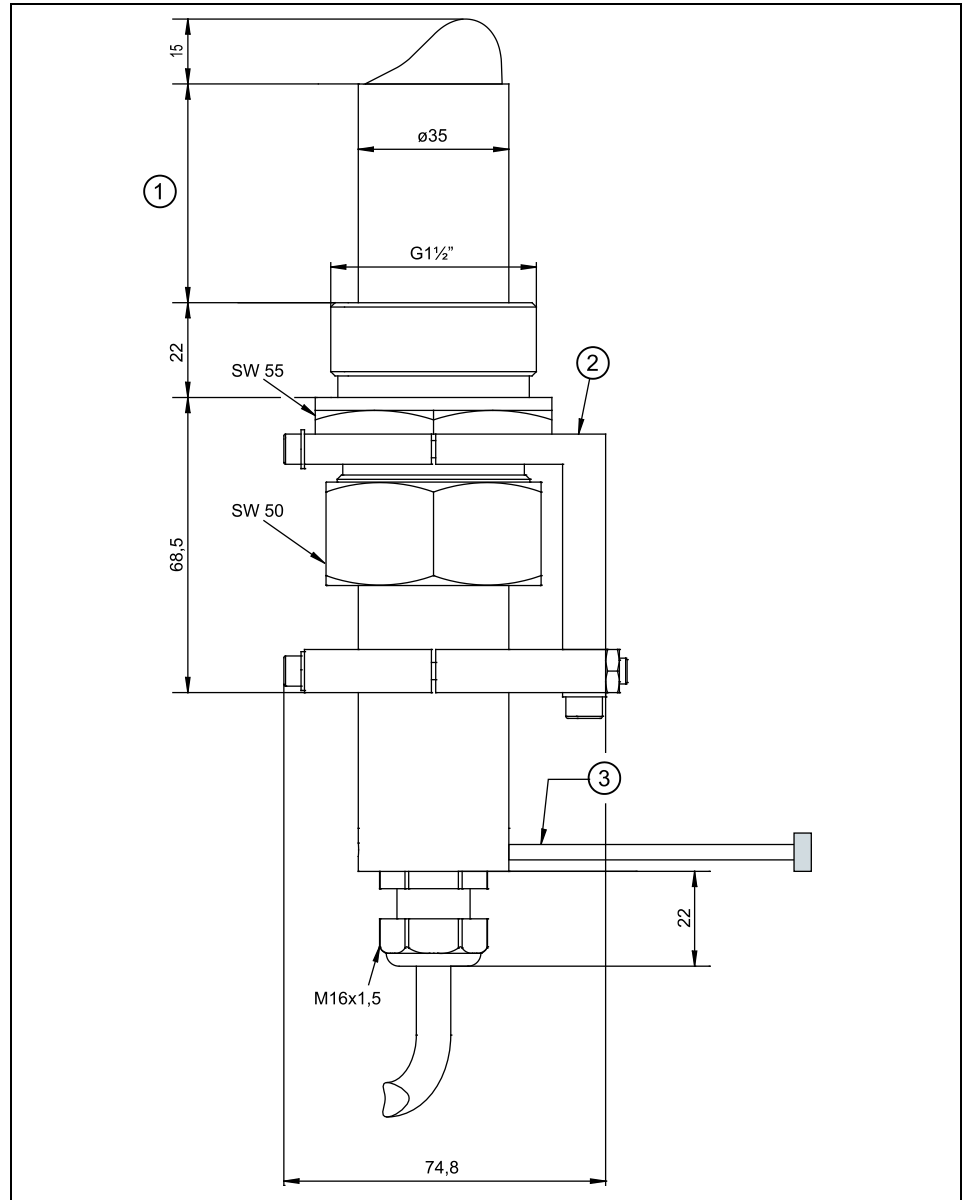

- 1 = movable Type R2: 200 mm / Type R3: 300 mm (with stop ball valve)
 2 = Retaining element
 3 = 180° to flow direction

Fig. 5-2 Dimensions KDA pipe sensor

5.2 Sensor Installation



Removing or loosening from ground plate or cable gland result in leakage and therefore will cause measurement and sensor failure.

Do absolutely not remove any parts of the sensor!! Otherwise warranty as well as Ex protection will expire!

Selecting the proper sensor position, required calming sections, installation of the sensors as well as cable laying is described in the separate „Installation Manual for Sensors“.

5.3 Plug wiring

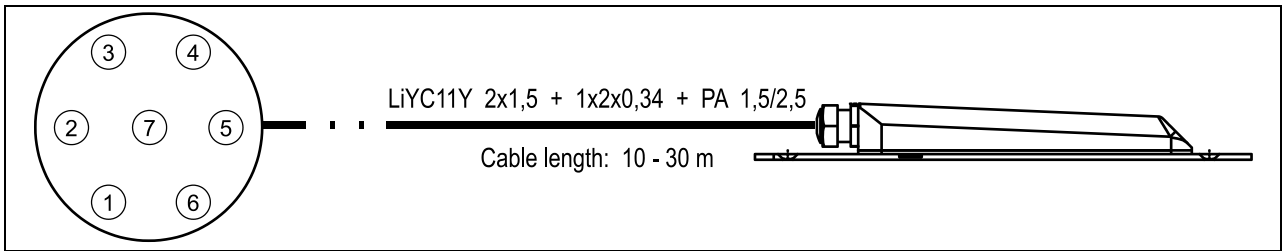
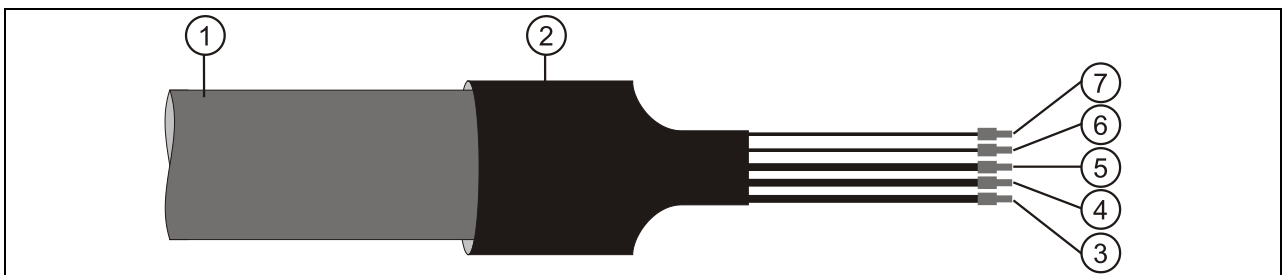

Fig. 5-3 Plug wiring water-ultrasonic sensors

Plug wiring	Function/max. values
1	UE (voltage input, max. 8.7V with Ex version, max. 24V with non-Ex version)
2	RxTx + (RS485)
3	not connected
4	not connected
5	RxTx - (RS485)
6	UE-GND (power supply ground)
7	shield (cable shield)

5.4 Cable end configuration



- 1 sensor jacket
- 2 shrunk-on hose
- 3 black; cable shield (no ground)
- 4 red; power supply +; max. 8.7 V with Ex version, max. 24 V with non-Ex version
- 5 blue; power supply -
- 6 white; RxTx +
- 7 green; RxTx -

Fig. 5-4 Cable end configuration; sensors without pressure measurement cell

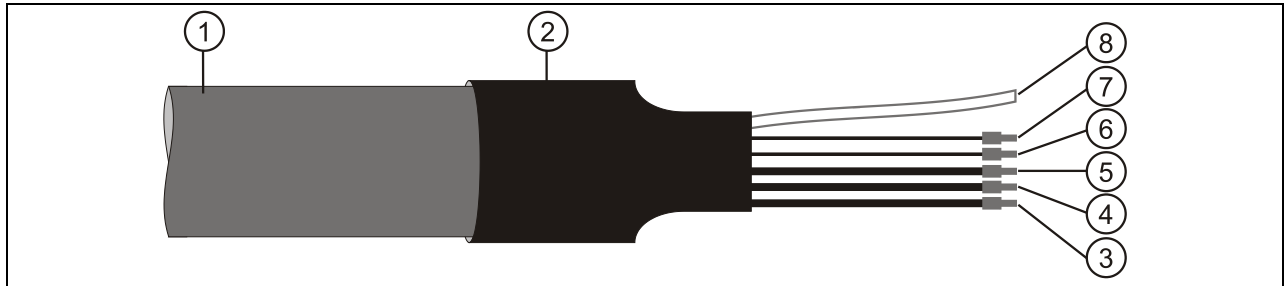

- 1 sensor jacket
- 2 shrunk-on hose
- 3 black; cable shield (no ground)
- 4 red; power supply +; max. 8.7 V with Ex version, max. 24 V with non-Ex version
- 5 blue; power supply -
- 6 white; RxTx +
- 7 green; RxTx -
- 8 air compensation hose

Fig. 5-5 Cable end configuration; sensors with pressure measurement cell

5.5 Sensor cable

5.5.1 Cable extension

Sensors with integrated pressure cell and sensor connection, type „L“ (see Fig. 3-2) are equipped with a specially prepared cable Type LIY11Y 2x1.5 mm² + 1x2x0.34 mm² + PA 1.5/2.5. Sensors without pressure measurement cell and sensor connection, type „K“ have cables type LIY11Y 2x1.5 mm² + 1x2x0.34 mm². These sensors with single shielded signal cables can be extended without any problem.

Two wires are required for bus communication. Connect remaining wires in parallel in a way to obtain 2 lines for power supply (same number of wires for each line).

In other countries technically equivalent cable types are permissible.



When using Ex sensors please observe line capacity and inductance of the cables used as well as the maximum permissible values described in Chap. 2.3.1.

The maximum permissible length of the fixed cable between flow velocity sensor and transmitter is 150 m. The maximum cable length may be extended to up to 250 m as follows: use non-Ex sensors with 30 m (98.4 ft) fixed cable and extend the cable by using a connection box together with an extension cable with a larger cross-section than the fixed cable.

A maximum cable length of 250 m is possible as soon as a non-Ex flow velocity sensor with a fixed cable of 30 m max. is extended by using a cable with a larger cross-section and a junction box.



The maximum cable extension for Ex Sensors is 150 m.



It is not allowed to use common extensions in case of different applications or to use a common signal cable to extend separate level and flow velocity measurements.



If you use a connection box in order to extend the cable, this box must be made of metal. Please necessarily connect the shields of feed and return cable to the shield connections of the metal connection box.

Improper connections which lead to higher transition resistance or the use of other cables may lead to disturbance and errors in the measurement.

Sensors with pressure measurement cell and Type "F" or "S" sensor connection are equipped with a pre-configured plug; Type "F" is additionally equipped with a pre-configured filter element which operates as pressure compensation element. These sensors cannot be extended.

The signal cable fixed on the sensor is not designed to be laid in the ground permanently. If you wish to lay signal cables into soils, concrete or similar please use additional protective pipes or hoses with sufficient inner diameters. Please select inner diameter, bending radius and layout of protective pipes and hoses in a way which enables to remove old signal cables and to draw in new ones without any problems.

5.5.2 Pressure Compensation Element

For sensors with pressure measurement cell (Types KDA-KP10, see Fig. 3-2) the maximum uninterrupted cable length is 30 m (90 ft). For cable extension a connection box with pressure compensation (pressure compensation element) has to be installed.

The pressure compensation element shall be installed as well if the cable of a sensor with integrated pressure measurement cell is to be connected directly to Type OCM F or OCM FR transmitters. The element can be ordered directly from NIVUS using Art.-No. >ZUB0 DAE<.



Operating sensors with integrated pressure measurement cell without pressure compensation element for a longer period of time may lead to irreversible damage of sensor electronics.

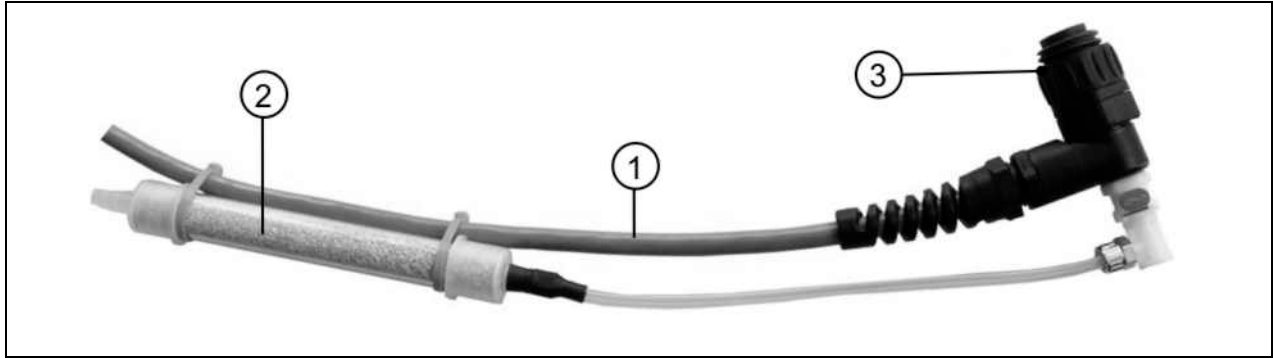

- 1 Sensor cable
- 2 Filter element
- 3 Plug with union nut

Fig. 5-6 Connection plug with air filter for connection to PCM

The pressure compensation element (for the connection to a OCM F or PCM F transmitter) supplied by NIVUS consists several components (see Fig. 5-7).

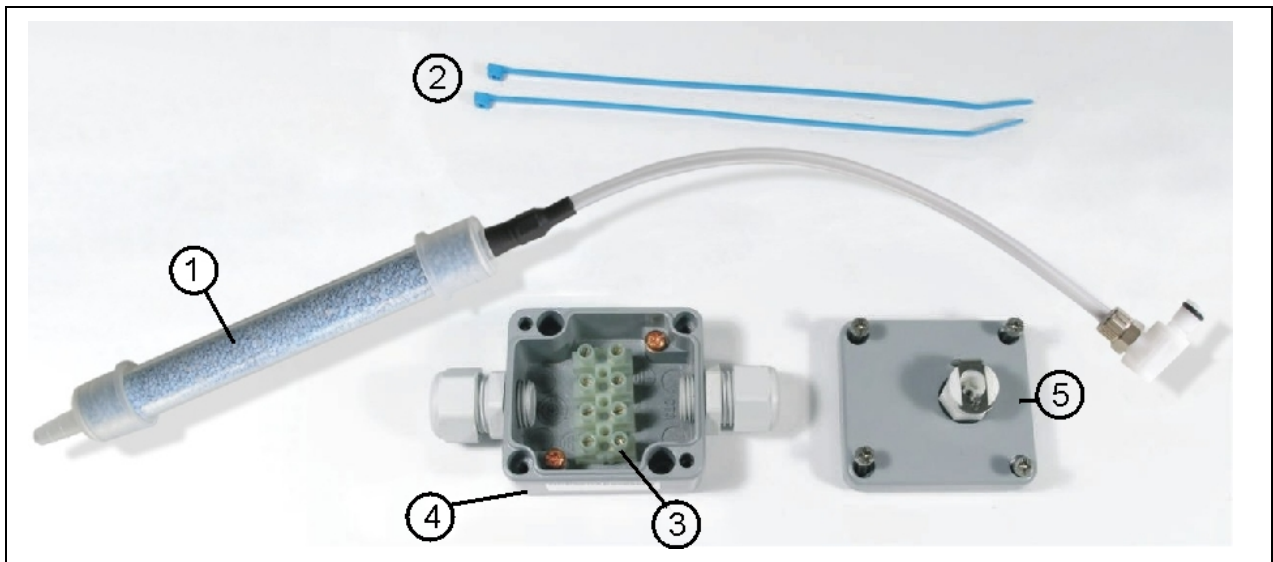

- 1 Filter element with air hose and air plug
- 2 Cable clips
- 3 Terminal clamps
- 4 Connection box
- 5 Box cover incl. self-locking socket for air hose plug

Fig. 5-7 Components of air compensation element

The 5-wire cable coming from the combi sensor must be connected 1:1 to the terminal clamp strip in the connection box. In this case please observe only to connect the power supply (red + blue) and the signal bus lines (white + green) to the terminal clamp strip. The cable shield (black) must **NECESSARILY** be connected to one of the both shield connection clamps within the box (Fig. 5-8).

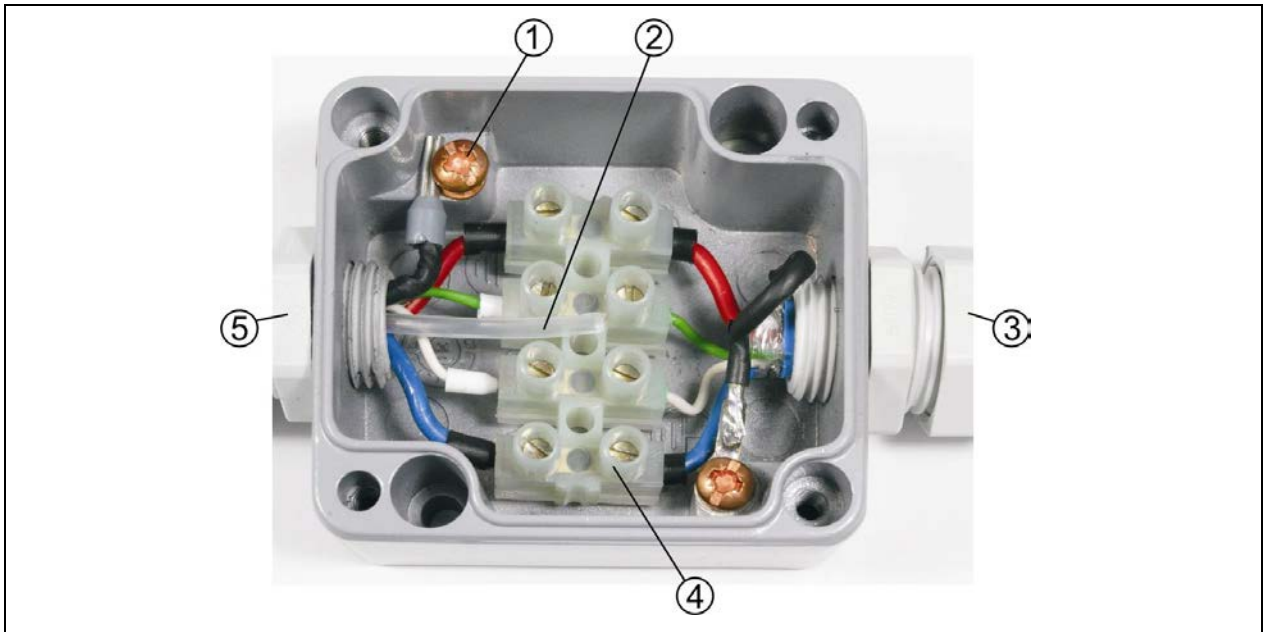

- 1 Shield
- 2 Air hose
- 3 Transmitter side
- 4 Terminal clamps
- 5 Flow velocity sensor side

Fig. 5-8 Open connection box

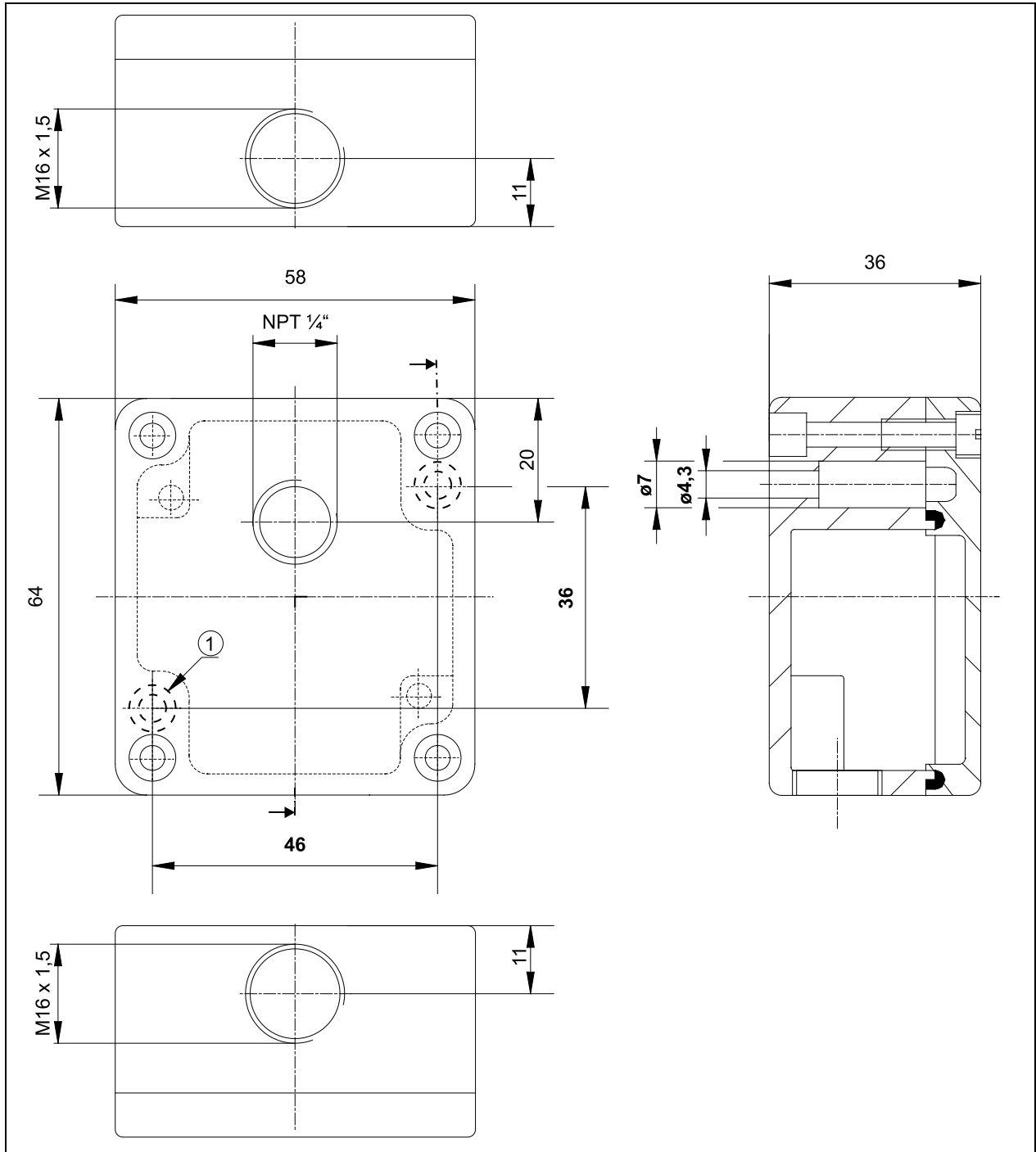

1 Drill holes for fastening

Fig. 5-9 Dimensions of the junction box

Extension from connection box to transmitter is carried out as described below by using A2Y or similar appropriate shielded signal cables.

After correct connecting the cables correctly fix the air filter with the cable clips on one of both cables in a way that the opening of the filter element looks downwards. Snap the air hose plug into the socket on the box lid and screw the lid onto the box subsequently.

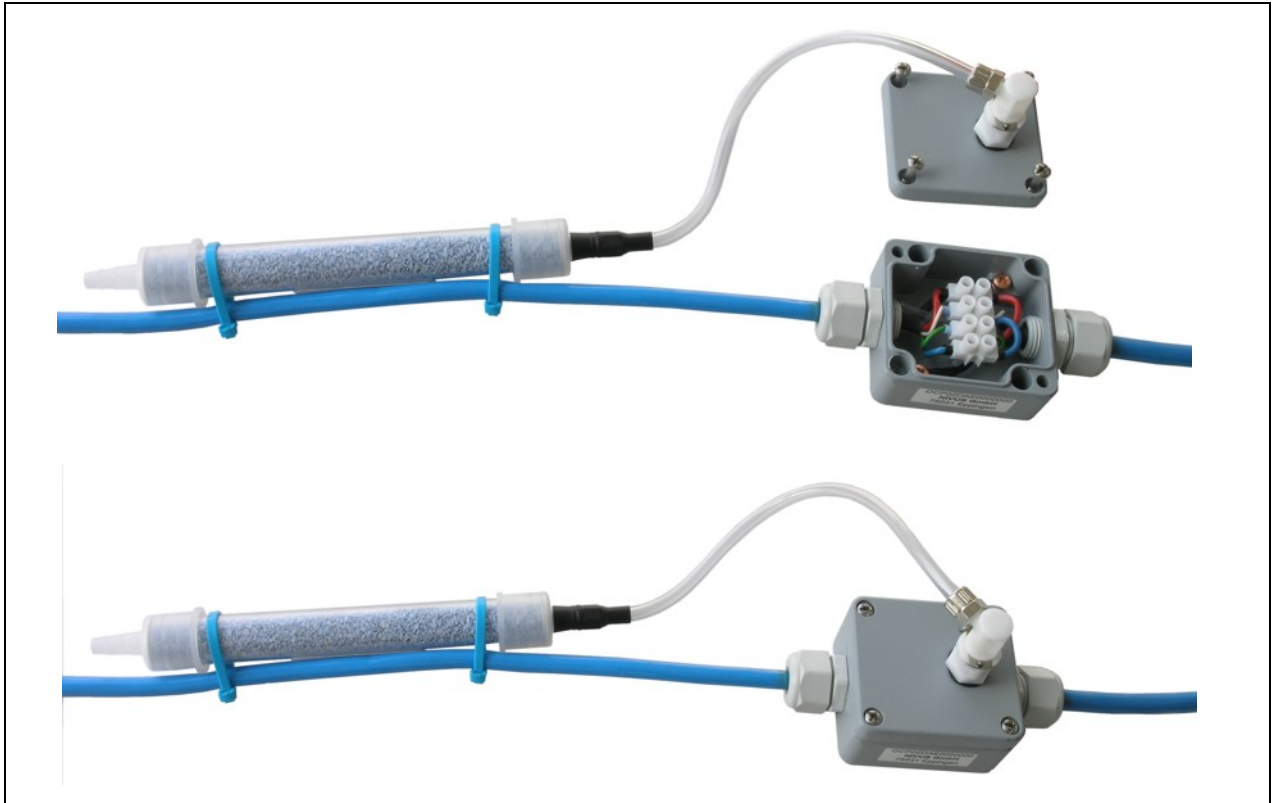

Fig. 5-10 Assembled pressure compensation element



The connection box with air compensation has to be installed in an area without corrosive gases and which is durably protected from being flooded.

Never operate the measurement incl. pressure compensation element with unplugged air hose plug automatic self-locking mechanism of the integrated socket → will shift the zero point of the level measurement).

The opening of the filter element must look downwards always.



Please necessarily connect the shields of feed and return cable to the shield connections of the metal connection box.

6 Table of Resistiveness

The medium contacting parts of the sensors consist of:

- PVDF (wedge sensor body)
- Stainless steel 1.4571 (V4A) (ground plate or pipe sensor jacket)
- Polyurethane (cable sheath and glands)

The following materials are used additionally for sensors with pressure measurement cell:

- Hastelloy® C-276 (Diaphragm of pressure measurement cell)
- Viton® (PA/PR) (gasket)

The sensor technology is resistant to normal domestic sewages, dirt and rain water as well as mixed water from municipalities and communities. Also in many industrial plants (e.g. Huels, BASF etc.) the resistance does not present any problems. The sensor technology nevertheless is not resistant to all substances and substance mixtures.



As a basic principle, damage might occur in case of using chloride media (pitting corrosion in stainless steel ground plate or PPE sensor jacket), hydrogen sulphide (H_2S – risk of diffusion through cable sheath or sensor body resulting in destruction of copper wires and conductor paths) as well as various organic solvents (may dissolve cable sheath or sensor body)!

Please observe that substance mixtures (several substances being present simultaneously) under certain circumstances may cause catalytic effects which might not occur if the individual substances are in use. Due to infinitely possible combinations these catalytic effects cannot be verified entirely.

If in doubt please contact your NIVUS representative and request a free material sample for long time testing purposes.

For use in special applications with high aggressive or solvent-containing media there are cables with FEP-coating available (for sensors without pressure measurement only).

For special applications conducting highly aggressive or solvent-containing media there are sensors featuring ground plates made of Hastelloy- or Titanium or pipe sensors with high-resistant special steel bodies available.

MEDIUM	FORMEL	CONCENTRATION	PUR	FEP	V4A	Hastelloy C 276	Viton (PA/PR)	PVDF
Acetaldehyde	C ₂ H ₄ O	40 %	4	(1)	(1)	0	4/4	3/0
Acetic acid	C ₂ H ₄ O ₂	10 %	3	1/1	1/1	1	(3)	1/1
Acetic acid methylester	C ₃ H ₆ O ₂	tech. clean	0	1/0	1/1	1	4/4	0/0
Aceton	C ₃ H ₆ O	40 %	4	(1)	1/1	1	4/4	3/3
Allyl alcohol	C ₃ H ₆ O	96 %	0	1/1	1/1	0	4/4	0/0
Aluminium chloride	AlCl ₃	10 %	0	1/1	3/4	1	1/0	1/1
Ammonium chloride	(NH ₄)Cl	aqueous	0	1/1	1/2L	1	1/1	1/1
Ammonium hydroxide	NH ₃ + H ₂ O	5 %	4	1/1	1/1	1	(2)	1/1
Anilin	C ₆ H ₇ N	100 %	4	1/1	1/0	1	2/4	1/2
Benzene	C ₆ H ₆	100 %	2	1/1	1/1	1	3/3	1/2
Benzin, bleifrei	C ₅ H ₁₂ - C ₁₂ H ₂₆		2	1/1	1/1	1	(1-3)	1/1
Benzyl alcohol	C ₇ H ₈ O	100 %	2	1/1	1/1	1	1/0	1/1
Benzyl alcohol	H ₃ BO ₃	10 %	1	1/1	1/1	1	1/1	1/1
Benzyl alcohol	HBrO ₃	concent.	3	0/0	(4)	0	(2)	1/1
Benzyl alcohol	C ₄ H ₁₀ O	tech. clean	3	1/1	(1)	1	3/4	1/1
Benzyl alcohol	CaCl ₂	spirituous	1	1/1	1/2L	1	1/1	1/1
Carbon disulphide	CS ₂	100 %	0	1/1	1/1	1	1/0	1/0
Carbon tetrachloride (TETRA)	CCl ₄	100 %	4	1/1	1/1L	1	1/1	1/1
Chloric gas	Cl ₂		3	1/1	1/0	0	1/1	1/1
Chloric methane	CH ₃ Cl	tech. clean	4	1/0	1/1L	0	4/4	0/0
Chlorine water	Cl ₂ x H ₂ O		0	(1)	2/0L	1	1/0	0/0
Chlorobenzene	C ₆ H ₅ Cl	100 %	4	1/1	1/1	1	3/4	1/1
Chloroform	CHCl ₃	100 %	4	1/1	1/1	1	4/4	1/1
Chromate	CrO ₃	10 %	0	1/1	1/2	1	1/1	0/0
Citric acid	C ₆ H ₈ O ₇	10 %	1	1/1	1/1	1	1/1	1/1
Diesel oil	—	100 %	0	(1)	(1)	0	1/1	1/1
Essential oils	—		1	(1)	1/1	0	1/0	0/0
Ethanol	C ₂ H ₆ O	96 %	1	1/1	1/1	1	3/0	0/0
Ethyl acetate	C ₄ H ₈ O ₂	100 %	3	1/1	(1)	0	4/4	1/2
Ethyl alcohol	C ₂ H ₆ O	100 %	1	1/1	1/1	0	3/0	0/0
Ethylen chloride	C ₂ H ₄ Cl ₂		3	1/1	1/1L	1	3/0	1/2
Ferric-(III)-chloride	FeCl ₃	saturated	3	1/1	4/4	0	1/1	1/1
Formaldehyde solution	CH ₂ O	10 %	2	1/1	1/1	1	3/0	1/1
Glycerol	C ₃ H ₈ O ₃	90%	2	1/1	1/1	1	1/1	1/1
Heptan, n-	C ₇ H ₁₆	90%	1	1/1	1/1	1	1/1	1/1
Hexan, n-	C ₆ H ₁₄	100 %	2	1/1	1/1	1	1/1	1/1
Hydrochloric acid	HCl	1-5 %	3	1/1	4/4	1	1/1	1/1
Hydrofluoric acid	HF	50 %	3	1/1	4/4	2	1/3	1/1
Isopropanol	C ₃ H ₈ O	tech. clean	2	1/1	(1)	1	1/1	0/0
Magnesium chloride	MgCl ₂	aqueous	2	1/1	1/0L	1	1/1	1/1
Methanol	CH ₄ O		2	1/1	1/1	1	3/4	0/0
Methyl benzene (toluene)	C ₇ H ₈	100 %	3	1/1	1/1	0	3/3	1/1
Milchsäure	C ₃ H ₆ O ₃	3 %	0	1/1	1/1	1	1/1	1/2
Mineral oil	—		1	1/1	1/1	1	1/1	1/1
Nitric acid	HNO ₃	1-10 %	3	1/1	1/1	1	1/1	1/1
Nitrobenzene	C ₆ H ₅ NO ₂		4	1/1	1/1	0	4/4	1/2
Oleic acid	C ₁₈ H ₃₄ O ₂	tech. clean	1	(1)	1/1	0	2/2	1/1
Oxalic acid	C ₂ H ₂ O ₄ x 2H ₂ O	aqueous	0	1/1	1/3	2	1/1	1/1
Ozone	O ₃		2	1/1	0/0	0	1/0	1/1
Petroleum	—	tech. clean	1	(1)	1/1	0	1/0	0/0
Phenol	C ₆ H ₆ O	100 %	2	1/1	1/1	1	2/3	1/1
Phosphoric acid	H ₃ PO ₄	85 %	0	1/1	1/3	1	1/1	1/1
Potassium hydroxide	KHO	10 %	3	1/1	1/1	1	4/4	1/1
Potassium nitrate	KNO ₃	aqueous	0	1/1	1/1	1	1/1	1/1
Quicksilver-(II)-chloride	HgCl ₂	aqueous	0	1/1	(4)	1	1/1	1/1
Sodium bisulphite	NaHSO ₃	aqueous	0	(1)	1/1	1	1/0	1/1
Sodium carbonate	Na ₂ CO ₃	aqueous	3	1/1	1/1	1	1/1	1/1
Sodium chloride	NaCl	aqueous	2	1/1	1/2	1	1/1	1/1
Sodium hydroxide	NaHO	50 %	3	1/1	1/3	1	3/3	0/0
Sodium sulphate	Na ₂ SO ₄	aqueous	0	1/1	1/1	1	1/1	1/1
Sulphuric acid	H ₂ SO ₄	40 %	3	1/1	2/3	1	1/1	1/1
Trichloroethylene (TRI)	C ₂ HCl ₃	100 %	4	1/1	1/1L	1	1/3	1/1

More comprehensive lists can be requested from NIVUS GmbH in Eppingen.

6.1 Resistiveness Legend

There are two values per medium.

left number = value at +20 °C / right number = value at +50 °C.

- 0 no specifications available
- 1 very good resistance/suitable
- 2 good resistance/suitable
- 3 limited resistance
- 4 not resistant
- K no general specifications possible
- L risk of pitting corrosion or stress corrosion cracking
- () estimated value

Material Names

- PUR Polyurethane
- FEP Tetrafluorethylene-Perfluorpropylene (Teflon® FEP)
- V4A Stainless steel 1.4401 (AISI 316)
- PVDF Polyvinylidenfluoride

7 Maintenance and Cleaning



Due to using the sensors mostly in the waste water field which may be contaminated with hazardous germs, please ensure to take respective precautions getting in contact with system, transmitter, cables and sensors.

In heavily polluted media tending to sedimentation it may be necessary to clean the flow velocity sensor regularly. To do this, please use a brush with plastic bristles, a broom or similar.



No hard objects such as wire brushes, rods, scrapers or similar shall be used to clean the sensor. Cleaning by using a water jet is allowed up to a max. pressure of 4 bar (see Specifications) (e.g. using a water hose). Never clean flow velocity sensors with pressure measurement cell (Types KP10) by using a water jet!

Using a high pressure cleaner may damage the sensor resulting in measurement failure and is therefore absolutely not allowed.

7.1 Combi Sensor with Pressure Measurement Cell

Due to physical reasons, level measurements performed by sensors with pressure measurement cell are subject to long-term drift (see chap. 2.3.1). NIVUS therefore recommends to calibrate sensors with integrated pressure measurement cell twice a year regarding the respective zero point. The best results are going to be achieved if the water level is as low as possible or if the sensor has been removed from the measurement medium. The calibration procedure is described in according Instruction Manuals of OCM F or PCM F transmitters.

If the measurement medium contains substances (e.g. grease, lime) which may sediment on the pressure opening, they must be removed in order to prevent measurement faults.

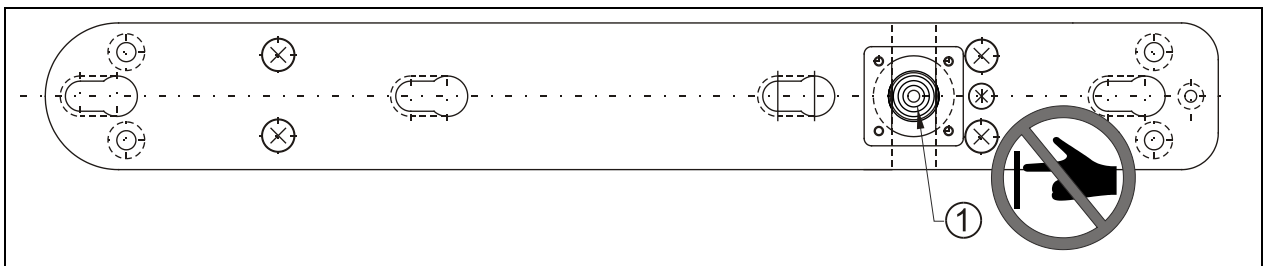

1 Pressure sensor

Fig. 7-1 Wedge sensor with pressure measurement cell, bottom view

The duct to the pressure measurement which is milled into the ground plate must be flushed with water immediately after each de-installation to avoid sedimentation. To do this, immerge the probe into water several times.

The cover on the pressure measurement can be removed for more extensive cleaning purposes.



Never use any pressure (e.g. water jet, screw driver) to clean the pressure measurement cell. This results in destruction of the cell!



Removing or loosening from ground plate or cable gland results in leakage and therefore will cause measurement and sensor failure.

Only the cover of the pressure measurement is allowed to be removed. Do absolutely not remove other parts of the sensor!!

Please be very careful when you clean the opened pressure measurement cell. It is allowed to be cleaned by using slight flushing movements in a vessel filled with water only. It is not permitted to touch the probe with a brush, fingers, tools, water jets or similar! Ignoring this ban results in expiry of the warranty!

If in doubt please let NIVUS do the cleaning in order to avoid the risk of warranty forfeiture.



If sedimentation which cannot be removed prevents correct measurement the sensor must be maintained by NIVUS.

The combination sensors with pressure measurement cell are equipped with an additional air filter with a dehydration agent on the connection plug. This dehydration agent is subject to normal wear which depends on measurement duration, measurement interval, air pressure fluctuation and environmental conditions. The filter wear is indicated by the dehydration agent turning from blue to bright pink.

The air filter has to be controlled each time before use, replacing the battery or reading data. If the desiccant starts changing colour, the air filter must be replaced by a new one of the same type.

Spare filters are available from NIVUS under Art. No. POA0 ZUBFIL00000.

7.2 Pressure Compensation Element

Inspect the filter element regularly (see Fig. 5-6) when mounting sensors with pressure measurement cell and pressure compensation element.

Inspection intervals depend on the prevailing air humidity and may vary between 2 and 12 weeks depending on application.

If the desiccant colour should change by more than 50 % (from blue to bright pink) replace the filter or the desiccant. Both can be purchased from NIVUS.

8 Dismantling/Disposal

The device has to be disposed according to the local regulations for electronic products.

9 Table of Pictures

Fig. 2-1	Sensor Overview	6
Fig. 2-2	Overview wedge sensor	6
Fig. 2-3	Overview Pipe Sensor	7
Fig. 3-1	Nameplate flow velocity sensor wedge and pipe	12
Fig. 3-2	Type key for KDA sensors	14
Fig. 5-1	Dimensions KDA wedge sensor	16
Fig. 5-2	Dimensions KDA pipe sensor	17
Fig. 5-3	Plug wiring water-ultrasonic sensors	18
Fig. 5-4	Cable end configuration; sensors without pressure measurement cell	18
Fig. 5-5	Cable end configuration; sensors with pressure measurement cell	19
Fig. 5-6	Connection plug with air filter for connection to PCM	21
Fig. 5-7	Components of air compensation element	21
Fig. 5-8	Open connection box	22
Fig. 5-9	Assembled pressure compensation element	24
Fig. 7-1	Wedge sensor with pressure measurement cell, bottom view	28

EU Konformitätserklärung

EU Declaration of Conformity

Déclaration de conformité UE

NIVUS GmbH
Im Täle 2
75031 Eppingen

Telefon: +49 07262 9191-0
Telefax: +49 07262 9191-999
E-Mail: info@nivus.com
Internet: www.nivus.de

Für das folgend bezeichnete Erzeugnis:

For the following product:

Le produit désigné ci-dessous:

Bezeichnung:	Kompaktdoppler-Aktivsensoren
<i>Description:</i>	<i>Compact Doppler active sensors</i>
<i>Désignation:</i>	<i>Capteurs Doppler compact actif</i>
Typ / Type:	KDA-K.../ KDA-R.../ KDS-K.../ KDS-R...

erklären wir in alleiniger Verantwortung, dass die auf dem Unionsmarkt ab dem Zeitpunkt der Unterzeichnung bereitgestellten Geräte die folgenden einschlägigen Harmonisierungsvorschriften der Union erfüllen:

we declare under our sole responsibility that the equipment made available on the Union market as of the date of signature of this document meets the standards of the following applicable Union harmonisation legislation:

nous déclarons, sous notre seule responsabilité, à la date de la présente signature, la conformité du produit pour le marché de l'Union, aux directives d'harmonisation de la législation au sein de l'Union:

- 2014/30/EU
- 2011/65/EU

Bei der Bewertung wurden folgende einschlägige harmonisierte Normen zugrunde gelegt bzw. wird die Konformität erklärt in Bezug die nachfolgend genannten anderen technischen Spezifikationen:

The evaluation assessed the following applicable harmonised standards or the conformity is declared in relation to other technical specifications listed below:

L'évaluation est effectuée à partir des normes harmonisées applicable ou la conformité est déclarée en relation aux autres spécifications techniques désignées ci-dessous:

- EN 61326-1:2013

Diese Erklärung wird verantwortlich für den Hersteller:

This declaration is submitted on behalf of the manufacturer:

Le fabricant assume la responsabilité de cette déclaration:

NIVUS GmbH
Im Täle 2
75031 Eppingen
Allemagne

abgegeben durch / *represented by / faite par:*

Marcus Fischer (Geschäftsführer / *Managing Director / Directeur général*)

Eppingen, den 20.04.2016

Gez. *Marcus Fischer*

UK Declaration of Conformity

NIVUS GmbH
Im Tale 2
75031 Eppingen

Telefon: +49 07262 9191-0
Telefax: +49 07262 9191-999
E-Mail: info@nivus.com
Internet: www.nivus.de

For the following product:

Description:	Compact Doppler active sensors
Type:	KDA-K.../ KDA-R.../ KDS-K.../ KDS-R...

we declare under our sole responsibility that the equipment made available on the UK market as of the date of signature of this document meets the standards of the following applicable UK harmonisation legislation:

- SI 2016 / 1091 The Electromagnetic Compatibility Regulations 2016
- SI 2012 / 3032 The Restriction of the Use of Certain Hazardous Substances in Electrical and Electronic Equipment Regulations 2012

The evaluation assessed the following applicable harmonised standards or the conformity is declared in relation to other technical specifications listed below:

- BS EN 61326-1:2013

This declaration is submitted on behalf of the manufacturer:

NIVUS GmbH
Im Tale 2
75031 Eppingen
Germany

represented by:

Ingrid Steppe (Managing Director)

Eppingen, 20/10/2022

Signed by *Ingrid Steppe*

EU Konformitätserklärung

EU Declaration of Conformity

Déclaration de conformité UE

NIVUS GmbH
Im Täle 2
75031 Eppingen

Telefon: +49 07262 9191-0
Telefax: +49 07262 9191-999
E-Mail: info@nivus.com
Internet: www.nivus.de

Für das folgend bezeichnete Erzeugnis:

For the following product:

Le produit désigné ci-dessous:

Bezeichnung:	"Ex" Kompaktdoppler-Aktivsensoren
<i>Description:</i>	<i>"Ex" Compact Doppler active sensors</i>
<i>Désignation:</i>	<i>"Ex" Capteurs Doppler compact actif</i>
Typ / Type:	KDA-KxxxE... / KDA-RxxxE...

erklären wir in alleiniger Verantwortung, dass die auf dem Unionsmarkt ab dem Zeitpunkt der Unterzeichnung bereitgestellten Geräte die folgenden einschlägigen Harmonisierungsvorschriften der Union erfüllen:

we declare under our sole responsibility that the equipment made available on the Union market as of the date of signature of this document meets the standards of the following applicable Union harmonisation legislation:

nous déclarons, sous notre seule responsabilité, à la date de la présente signature, la conformité du produit pour le marché de l'Union, aux directives d'harmonisation de la législation au sein de l'Union:

- 2014/30/EU
- 2014/34/EU
- 2011/65/EU

Bei der Bewertung wurden folgende einschlägige harmonisierte Normen zugrunde gelegt bzw. wird die Konformität erklärt in Bezug die nachfolgend genannten anderen technischen Spezifikationen:

The evaluation assessed the following applicable harmonised standards or the conformity is declared in relation to other technical specifications listed below:

L'évaluation est effectuée à partir des normes harmonisées applicable ou la conformité est déclarée en relation aux autres spécifications techniques désignées ci-dessous:

- EN 61326-1:2013
- EN IEC 60079-0:2018
- EN 60079-11:2012

Ex-Kennzeichnung / *Ex-designation* / *Marquage Ex* :

 II 2G Ex ib IIB T4 Gb

EU-Baumusterprüfbescheinigung / *EU-Type Examination Certificate* / *Attestation d'examen «UE» de type:*

IBExU 07 ATEX 1082 Ausgabe 1 / Issue 1

Notifizierte Stelle (Kennnummer) / *Notified Body (Identif. No.)* / *Organisme notifié (N° d'identification)*

IBExU Institut für Sicherheitstechnik GmbH, 09599 Freiberg, Allemagne

(0637)

Qualitätssicherung ATEX / *Quality assurance ATEX* / *Assurance qualité ATEX:*

TÜV Nord CERT GmbH, Am TÜV 1, 45307 Essen, Germany

(0044)

Diese Erklärung wird verantwortlich für den Hersteller:

This declaration is submitted on behalf of the manufacturer:

Le fabricant assume la responsabilité de cette déclaration:

NIVUS GmbH
Im Täle 2
75031 Eppingen
Allemagne

abgegeben durch / *represented by* / *faite par:*

Marcus Fischer (Geschäftsführer / *Managing Director* / *Directeur général*)

Eppingen, den 18.02.2022

Gez. *Marcus Fischer*

UK Declaration of Conformity

NIVUS GmbH
Im Täle 2
75031 Eppingen

Telefon: +49 07262 9191-0
Telefax: +49 07262 9191-999
E-Mail: info@nivus.com
Internet: www.nivus.de

For the following product:

Description:	"Ex" Compact Doppler active sensors
Type:	KDA-KxxxE... / KDA-RxxxE...

we declare under our sole responsibility that the equipment made available on the UK market as of the date of signature of this document meets the standards of the following applicable UK harmonisation legislation:

- SI 2016 / 1091 The Electromagnetic Compatibility Regulations 2016
- SI 2016 / 1107 The Equipment and Protective Systems Intended for use in Potentially Explosive Atmospheres Regulations 2016
- SI 2012 / 3032 The Restriction of the Use of Certain Hazardous Substances in Electrical and Electronic Equipment Regulations 2012

The evaluation assessed the following applicable harmonised standards or the conformity is declared in relation to other technical specifications listed below:

- BS EN 61326-1:2013
- BS EN IEC 60079-0:2018
- BS EN 60079-11:2012

Ex-designation:

 II 2G Ex ib IIB T4 Gb
IBExU 07 ATEX 1082 Issue 1

EU-Type Examination Certificate:

Notified Body (Identif. No.):

IBExU Institut für Sicherheitstechnik GmbH, 09599 Freiberg, Germany (0637)

Quality Assurance Ex:

TÜV Nord CERT GmbH, Am TÜV 1, 45307 Essen, Germany (0044)

This declaration is submitted on behalf of the manufacturer:

NIVUS GmbH
Im Taele 2
75031 Eppingen
Germany

represented by:

Ingrid Steppe (Managing Director)

Eppingen, 24/10/2022

Signed by *Ingrid Steppe*