

Instruction Manual

Flow Transmitter

NivuFlow Mobile 750 / NivuFlow Mobile 750 Ex



Firmware Version: 5.1.x

Revised Instruction Manual

Document Revision 05 / 11.01.2022

Original Instruction Manual: German / Rev. 05 as of
27.10.2021

measure analyse optimise

NIVUS AG, Switzerland

Burgstrasse 28
8750 Glarus, Switzerland
Phone +41 55 6452066
Fax +41 55 6452014
swiss@nivus.com
www.nivus.de

NIVUS Austria

Mühlbergstraße 33B
3382 Loosdorf, Austria
Phone +43 2754 5676321
Fax +43 2754 5676320
austria@nivus.com
www.nivus.de

NIVUS Sp. z o.o., Poland

ul. Hutnicza 3 / B-18
81-212 Gdynia, Poland
Phone +48 58 7602015
Fax +48 58 7602014
biuro@nivus.pl
www.nivus.pl

NIVUS France

12 rue Principale
67870 Bischoffsheim, France
Phone +33 388 999284
info@nivus.fr
www.nivus.fr

NIVUS Ltd., United Kingdom

Furzen Hill Farm
Coventry Road, Cubbington
Royal Leamington Spa
CV32 7UJ, Warwickshire
Phone +44 8445 332883
nivusUK@nivus.com
www.nivus.com

NIVUS Middle East (FZE)

Building Q 1-1 ap. 055
P.O. Box: 9217
Sharjah Airport International
Free Zone
Phone +971 6 5578224
Fax +971 6 5578225
middle-east@nivus.com
www.nivus.com

NIVUS Korea Co. Ltd.

#2301 M-Dong, Technopark IT Center,
32 Songdogwahak-ro, Yeonsu-gu,
INCHEON, Korea 21984
Phone +82 32 2098588
Fax +82 32 2098590
jhwon@nivuskorea.com
www.nivuskorea.com

NIVUS Vietnam

238/78 Phan Trung Street,
Tan Tien Ward, Bin Hoa City,
Dong Nai Province, Vietnam
Phone +84 94 2623979
jhwon@nivuskorea.com
www.nivus.com

Copyrights and Property Rights

The contents of this document including tables and drawings are proprietary to NIVUS GmbH and are not to be reproduced or copied without express written permission.

Violations oblige to compensation.



Important

This instruction manual - even in parts - may exclusively be copied or translated in any other way with the express written consent of NIVUS GmbH.

Translation

If the device is sold to a country in the European Economic Area this instruction manual must be translated into the language of the country in which the device is to be used.

Should the translated text be unclear, the original instruction manual (German) must be consulted or a member company of the NIVUS group must be contacted for clarification.

Copyright

No part of this publication may be reproduced, transmitted, sold or disclosed without prior permission. All rights reserved.

Names

The use of general descriptive names, trade names, trademarks and the like in this manual does not entitle the reader to assume they may be used freely by everyone. They are often protected registered trademarks even if not marked as such.

Revision History

Rev.	Modifications	Responsible Editor	Date
05	Firmware version updated; Chap. "2.2 NivuFlow Mobile Control Elements", "3.2 Warning Notices on the Device (optional)" and "18 Specifications" updated; Chap. "19.2 Add-On Function Licences" added; Fig. 21-4 Measured flow profile in the display changed; Chap. "22.2 Before Installation" extended; Chap. "23.2 Rechargeable Battery Block" updated; Fig. 27-2 Terminal wiring Connector Box updated; Chap. "30 Lighting System of the Status LED on NivuFlow Mobile" and "32.1 Overview Display" updated; Chap. "Main Screen" added; Chap. "37 Procedure for Setting Parameters via Quick Start", "38.2.6 Menu - Battery", "38.2.7 Menu - Quick Start", "39.1.6 System Times", "39.2.1 h-Sensor Types" "39.3.2 Selecting the Sensor Types" updated; Chap. "39.3.3 Float" added; Chap. "39.3.4 Mounting Position of Sensors" updated; Chap. "39.3.5 Weighting" added; Chap. "39.3.6 v-Determination low Levels" updated; Chap. "39.3.7 v-Minimum and v-Maximum" renamed; Chap. "39.4 Menu Inputs and Outputs (analogue and digital)", "40.3 Menu Data Memory", "41.2.4 Data Units", "41.4 Menu Error Messages", "41.5 Menu Service", "42 Parameter Menu Communication", "44 Parameter Menu Battery (12V)", "45 Parameter Menu Quick Start", "46 Parameter Menu Alarm", "Diagnostics", "58 Accessories" and "Approvals and Certificates" updated; minor changes in text and layout; various display images updated	MoG	11.01.2022
04	Chap. "8 Ex Protection" and "18 Specifications" updated; Chap. "28 (T-Shape) Antenna for GPRS Remote Data Transmission": Important Note added; Index updated	MoG	12.08.2020
03	Chap. "5 Warranty" added; Chap. "19 Configuration/Device Types" updated; Chap. "23.1 Battery Block", "27 Connecting the Connector Box for Inputs/Outputs" and "36.4.4 Digital Outputs changed; Chap. "52.2 Power Adapter/Battery Charger" added; Chap. "53 Dismantling/Disposal": note text on WEEE Directive of the EU updated; Chap. "Approvals and Certificates" updated; minor changes regarding text and layout	MoG	25.05.2020
02	Address NIVUS France updated; Chap. "1.3.1 Colour Code for Wires and Single Wires", "5 Disclaimer", "22.1.3 Operation/Charging via alternative Power Source", "24.2 Sensor Connection" changed; Chap. "24.3 Overvoltage Protection Measures" added; Chap. "26 Connecting the Connectorbox for Inputs/Outputs": Fig. 26 2 changed; Chap. "29 Lighting System of the Status LED on the NivuFlow Mobile" added; Chap. "30 Connection Setup": "Session Timeout" removed; Chap. "31.3 Menüs": "Alarm" added; Chap. "35.4.1 Analogue Inputs", "37.2.3 Units", "37.2.4 Units Memory" and "38 Communication Parameter Menu" changed; Chap. "42 Alarm Parameter Menu" added	MoG	11.04.2019
01	New firmware version; Ex Certificate/CE Declarations of Conformity replaced and accompanying references/images changed; Chap. 17: Weight adjusted; Chap. 18: Equipment/Device Versions updated; other chapters changed: 2.3, 20.2.4, 22.1.4 (also warning notice added),	MoG	23.10.2018

Revision History

35.3.2, 35.4.2, 35.4.3, 35.4.4, 37.3, 41.2 and 49; minor text corrections and various images adjusted			
00	New Creation based on the german version	MoG	31.07.2018

Table of Contents

Copyrights and Property Rights	3
Revision History	4
Table of Contents	6
General	11
1 About this Manual.....	11
1.1 Applicable Documentation	11
1.2 Signs and Definitions used	11
1.3 Abbreviations used.....	12
1.3.1 Colour code for wires and single conductors	12
2 Connections and Control Elements.....	12
2.1 Power Supply	12
2.1.1 Transmitter	12
2.1.2 Rechargeable battery blocks	12
2.2 NivuFlow Mobile Control Elements	13
2.3 Interfaces	14
Safety Instructions	15
3 Used Symbols and Signal Words.....	15
3.1 Information on the Valuation of Accident Levels.....	15
3.2 Warning Notices on the Device (optional).....	16
4 Special safety and Precautionary Measures.....	17
5 Warranty.....	18
6 Disclaimer.....	18
7 Intended Use	18
8 Ex Protection	19
9 Duties of the Operator	20
10 Requirements for the Personnel	20
Delivery, Storage and Transport	21
11 Scope of Delivery	21
12 Inspection upon Receipt.....	21
13 Storage.....	22
14 Transport.....	22
15 Return.....	22
Product Description	23
16 Product Construction and Overview.....	23
16.1 Enclosure dimensions	24
16.2 Connectable Sensors/Devices	24
17 Device ID.....	25
18 Specifications	26
19 Equipment	27
19.1 Device Versions	27
19.2 Add-On Function Licences.....	28

Function Description	29
20 Areas of Use.....	29
21 Functional Principles	29
21.1 Flow Velocity Measurement	29
21.1.1 Cross Correlation	29
21.2 Level Measurement.....	31
21.2.1 2-wire Level Sensor	31
21.2.2 Water-Ultrasound	31
21.2.3 Air-Ultrasound	32
21.2.4 Pressure.....	32
Installation and Connection	33
22 General Installation Information	33
22.1 Mounting Place	33
22.2 Before Installation	33
22.2.1 PU Adhesive Plates on the Enclosure Frame.....	33
22.2.2 Gaskets	33
22.2.3 Securing the Instrument.....	34
22.2.4 Connection Sockets	34
23 Electrical Installation/Power Supply	34
23.1 General Information on the Power Supply	34
23.2 Rechargeable Battery Block	35
23.2.1 Removing/installing the battery block	36
23.2.2 Charging the battery block	36
23.2.3 Operation/charging via an alternative voltage source.....	38
23.2.4 Operation/Charging with direct connection to mains power	39
24 Installation of Sensors	40
24.1 Sensor Installation Principles	40
25 Connection of Sensors	40
25.1 Cable for Sensor Connection	40
25.2 Connecting Sensors.....	40
25.2.1 Connection of Sensors directly to NivuFlow Mobile.....	40
25.2.2 Connecting flow velocity sensors via the adapter box	41
25.3 Overvoltage Protection Measures.....	42
26 Single external Connection for Inputs/Outputs	42
27 Connecting the Connector Box for Inputs/Outputs	43
28 (T-Shape) Antenna for 2G/3G/4G Remote Data Transmission	45
Commissioning	46
29 Notes to the User	46
30 Lighting System of the Status LED on NivuFlow Mobile.....	46
31 Connection Setup.....	48
31.1 Common.....	48
31.2 Android Operating System	48
31.3 iOS Operating System	52
31.4 Windows Operating System.....	55
32 Menu Control/Overview.....	58
32.1 Overview Display	58
32.2 Save Parameters	59
32.3 Menus.....	60

Main Screen	61
33 Functions of the Main Screen	61
34 General Overview.....	61
35 Display Fields	63
35.1 Display Field Flow	63
35.2 Display field level	64
35.3 Display Field Velocity	65
35.4 Display field Temperature	66
35.5 Display Field Total.....	66
Setting Parameters	67
36 General Programming.....	67
36.1 Save Parameters	67
36.2 Change WLAN Password	67
36.3 Change the device SSID.....	68
36.4 Loss of the Password.....	68
36.5 Automatic Data Transmission to USB Stick.....	69
37 Procedure for Setting Parameters via Quick Start	69
38 Parameter Functions.....	74
38.1 Main Menu	74
38.2 Functions of the first Menu Level	74
38.2.1 Menu - Application	74
38.2.2 Menu - Data	75
38.2.3 Menu - System	76
38.2.4 Menu - Communication	77
38.2.5 Menu - Display	77
38.2.6 Menu - Battery.....	78
38.2.7 Menu - Quick Start	79
38.2.8 Menu - Alarm.....	80
39 Parameter Menu Application.....	81
39.1 Menu Measurement Place	81
39.1.1 Name of the measurement place.....	81
39.1.2 Channel Profiles.....	82
39.1.3 Sludge Level	87
39.1.4 3D Preview.....	87
39.1.5 Low-flow suppression.....	87
39.1.6 System Times	88
39.2 Menu h-Sensors.....	89
39.2.1 h-Sensor Types.....	89
39.2.2 Definition of Measurement Ranges.....	91
39.3 Menu v-Sensors	93
39.3.1 Number of Flow Velocity Sensors.....	93
39.3.2 Selecting the Sensor Types	94
39.3.3 Float	94
39.3.4 Mounting Position of Sensors	94
39.3.5 Weighting	98
39.3.6 v-Determination low Levels.....	99
39.3.7 v-Minimum and v-Maximum.....	103
39.4 Menu Inputs and Outputs (analogue and digital).....	104
39.4.1 Analogue Inputs	105
39.4.2 Analogue Outputs	106

39.4.3	Digital Inputs	107
39.4.4	Digital Outputs.....	108
39.5	Menu Diagnostics.....	110
40	Parameter Menu Data.....	110
40.1	Menu Trend.....	111
40.2	Menu Day Totals	112
40.3	Menu Data Memory.....	114
41	Parameter Menu System	118
41.1	Menu Information	118
41.2	Menu Country Settings.....	119
41.2.1	(Operating) Language.....	119
41.2.2	Date Format	119
41.2.3	Units	119
41.2.4	Data Units	120
41.3	Menu Time/Date.....	121
41.4	Menu Error Messages.....	122
41.5	Menu Service	122
41.5.1	Service Level.....	123
41.5.2	Restart.....	123
41.5.3	Powerdown	123
41.5.4	Parameter Reset	123
41.5.5	Feature Unlock.....	124
41.5.6	Update NivuFlow Mobile 750	126
41.5.7	Update Bootloader	126
41.6	Menu Storage Mode.....	127
42	Parameter Menu Communication	129
43	Parameter Menu Display.....	134
44	Parameter Menu Battery (12V)	135
45	Parameter Menu Quick Start.....	136
45.1	Menu >Quick Start< / >Country Settings<	136
45.2	Menu >Quick Start< / >Measurement Place<.....	137
45.3	Menu >Quick Start< / >h-Sensors<	138
45.4	Menu >Quick Start< / >v-Sensor x<.....	138
45.5	Menu >Quick Start< / >Analogue Input x<.....	139
45.6	Menu >Quick Start< / >Digital Input 1<.....	139
45.7	Menu >Quick Start< / >Communication<.....	140
46	Parameter Menu Alarm	140
46.1	Menu >Alarm< / >Flow<.....	141
46.2	Menu >Alarm< / >Level<.....	142
46.3	Menu >Alarm< / >Velocity<.....	143
46.4	Menu >Alarm< / >Water Temperature<	144
46.5	Menu >Alarm< / >Air Temperature<	145
46.6	Menu >Alarm< / >Battery (12V)<	146
46.7	Menu >Alarm< / >Analogue Input 1<.....	146
46.8	Menu >Alarm< / >Analogue Input 2<	147
46.9	Menu >Alarm< / >Analogue Input 3<	148
46.10	Menu >Alarm< / >Digital Input<	149
Diagnosics		150
47	Basics of the Diagnostics Menu	150
48	Menu Diagnostics h-Sensors	151

49 Menu Diagnostics v-Sensors	152
50 Menu Diagnostics Inputs/Outputs	153
50.1 Important Information on Simulation	153
51 Menu Diagnostics Flow Profile	154
52 Menu Diagnostics Signal Analysis	155
53 Simulation.....	157
<u>Maintenance and Cleaning</u>	159
54 Maintenance.....	159
54.1 Maintenance Interval.....	159
54.2 Maintenance Tasks.....	160
54.2.1 Clean, check and replace Seals	160
54.3 Customer Service Information	160
55 Cleaning	160
55.1 Transmitter	160
55.2 Rechargeable Battery Blocks.....	161
55.3 Power Adapter/Charger	161
55.4 Sensors	161
56 Dismantling/Disposal.....	161
57 Installation of Spare Parts and Wearing Parts	161
58 Accessories	162
<u>Index</u>	164
<u>Credits and Licenses</u>	166
59 List of Sources of the Licences and Codes used.....	166
<u>Approvals and Certificates</u>	167

General

1 About this Manual



Important

READ CAREFULLY BEFORE USE.

KEEP IN A SAFE PLACE FOR LATER REFERENCE.

This instruction manual is for the NivuFlow Mobile 750 flow measurement device and serves its intended use. This instruction manual is oriented exclusively to qualified expert personnel.

Read this instruction manual carefully and completely prior to installation or connection since it contains relevant information on this product. Observe the notes and particularly follow the warning notes and safety instructions.

If you should have problems to understand information contained within this instruction manual either contact a member company of the NIVUS group or one of the distributors for further support. The member companies of the NIVUS group cannot be held responsible for damage to persons or material due to incorrectly understood information in this instruction.



1.1 Applicable Documentation

For the installation and operation of the complete system extra instruction manuals or technical descriptions may be required apart from this manual.

- Technical Description for Correlation Sensors and external Electronic Box
- Mounting Instruction for Cross Correlation and Doppler Sensors

These manuals are provided with the auxiliary units or sensors and/or are available as download on the NIVUS homepage.

1.2 Signs and Definitions used

Representation	Meaning	Remarks
	(Action) Step	Execute action steps. Should action steps be numbered observe the specified order of the steps.
	Cross-reference	Refers to further or more detailed information.
>Text<	Parameter or menu	Indicates a parameter or a menu that is to be selected or is described.
	Refers to a documentation	Refers to an accompanying documentation.

Tab. 1 Structural elements within the manual

1.3 Abbreviations used

1.3.1 Colour code for wires and single conductors

The abbreviations of colours for wire and single conductor labelling follow the international colour code according IEC 60757.

BK	Black	BN	Brown	RD	Red
OG	Orange	YE	Yellow	GN	Green
BU	Blue	VT	Violet	GY	Grey
WH	White	PK	Pink	TQ	Turquoise
GNYE	Green/Yellow	GD	Gold	SR	Silver

2 Connections and Control Elements

2.1 Power Supply

2.1.1 Transmitter

The NivuFlow Mobile (Fig. 2-1 Pos. 1) is powered via the rechargeable battery blocks. When plugged into the enclosure, these are connected to the transmitter via the charging pins (Fig. 2-1 Pos. 4) and provide the required operating voltage.

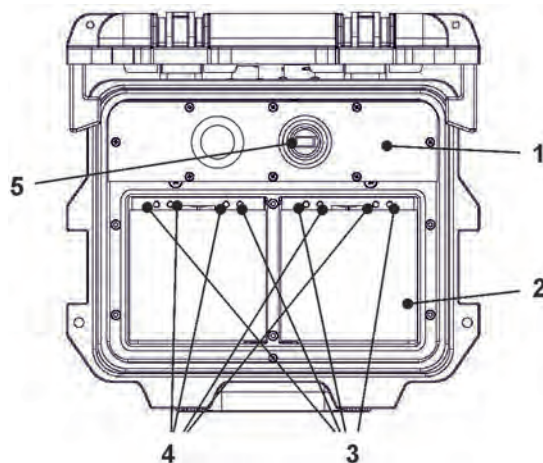

- 1 Transmitter
- 2 Battery compartment (for two rechargeable battery blocks; no image)
- 3 Guide pins for battery blocks
- 4 Charging pins for AC power supply of the transmitter
- 5 USB-A Interface

Fig. 2-1 Power supply by rechargeable /battery blocks (top view)

2.1.2 Rechargeable battery blocks

The battery blocks are charged either when installed or when removed with the aid of the charger (available as an accessory).

WARNING



Risk of explosion when charging the battery pack in Ex areas

*The battery pack may only be charged outside the Ex area. **Never within Ex areas.***

There are two different variants for charging the battery blocks when they are installed:

- Mains adapter 110...230 V AC via the multifunction socket (Fig. 2-2 Pos. 1) on the rear of the enclosure
- External power source 12...14 V DC (e.g. battery, solar module, fuel cell etc.) with connection cable via the multifunction socket

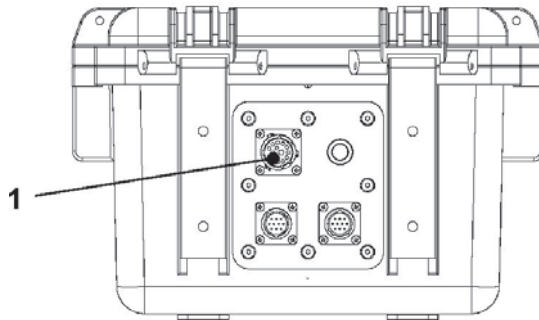

1 Multifunction socket

Fig. 2-2 Charging the rechargeable battery block via multifunction socket

⇒ Connection diagrams for the sensors can be found in Chapter "25 Connection of Sensors".

2.2 NivuFlow Mobile Control Elements

The NivuFlow Mobile is activated by the reed contact on the front. This is done by the enclosed ring magnet *ZUBO NFM MAGNET* (Fig. 2-3).

Beyond that, the NivuFlow Mobile has no other control elements. The entire operation and parameterisation are carried out via the respective smartphone, tablet, notebook or PC.



Also observe the instruction manuals for the smartphone, tablet, notebook or PC you are using.



Fig. 2-3 Ring magnet

2.3 Interfaces

The transmitter is equipped with several interfaces. These are on the back of the enclosure and on the top of the unit respectively.

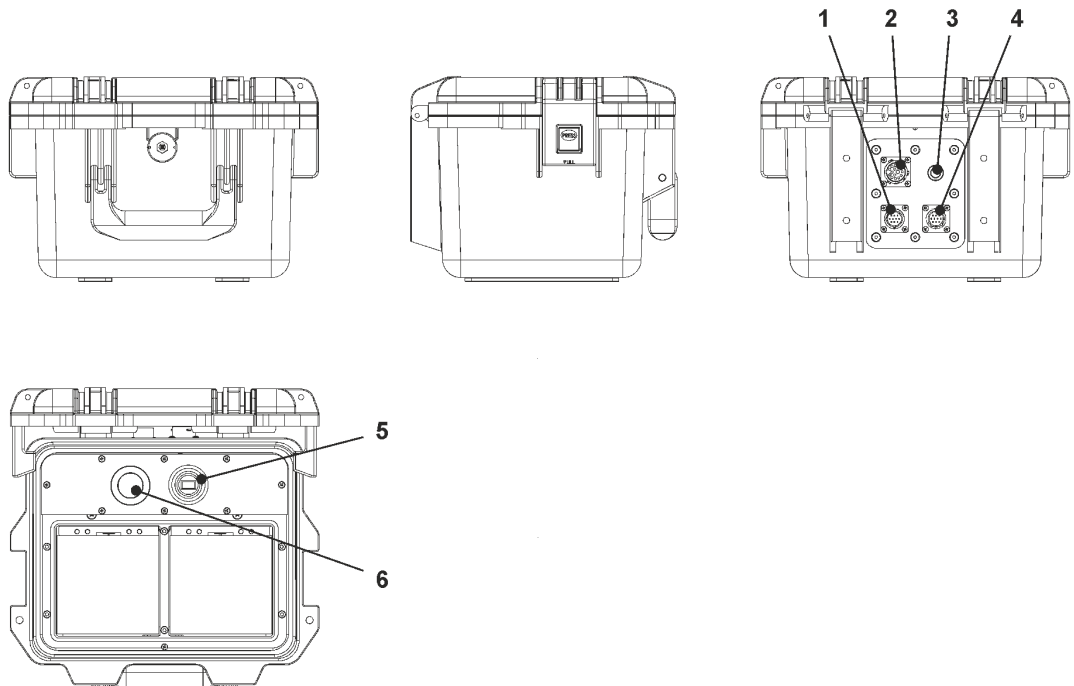

- 1 Sensor socket v2/h
- 2 Multifunction socket I/O
- 3 2G/3G/4G Antenna socket
- 4 Sensor socket v1
- 5 USB-A interface (accessible when the enclosure cover is open)
- 6 2G/3G/4G SIM card slot (in connection with 2G/3G/4G antenna; accessible when the enclosure cover is open)

Fig. 2-4 Available interfaces

Safety Instructions

3 Used Symbols and Signal Words

3.1 Information on the Valuation of Accident Levels



The general warning symbol indicates the risk of personal injuries or death. In the text section the general warning symbol is used in combination with the signal words described below.

DANGER

Warning in high degree of risk



Indicates a high-risk, **imminently** hazardous situation which will result in death or serious injury if not avoided.

WARNING

Warning in medium degree of risk and personal injury



Indicates a **possible** danger with medium risk which may result in a life-threatening situation or (severe) bodily injury if not avoided.

CAUTION

Warning in personal injury or property damage



Indicates a possible danger with moderate risk which may result in minor or moderate personal injury or property damage if not avoided.

WARNING

Danger by electric voltage



Indicates a medium-risk, **imminently** hazardous situation caused by electric shock which will result in death or (serious) injury if not avoided.



Important Note

Contains information that needs to be highlighted.
Indicates a potentially harmful situation that may damage the product or something in its environment if not avoided.



Note

Contains tips or information.

3.2 Warning Notices on the Device (optional)



General Warning Notice

*This symbol refers the operator or user to content in this manual.
Consideration of the information contained herein is necessary to maintain the protection provided by the unit for installation and in operation.*



Protective earth connection

*This symbol refers to the protective conductor terminal of the device.
Depending on the type of installation, the unit may only be operated with a suitable protective earth connection in accordance with applicable laws and regulations.*

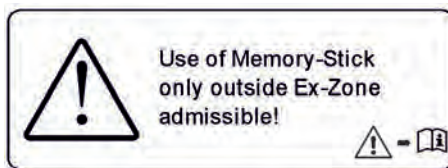
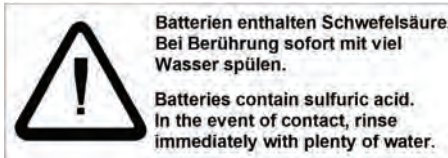
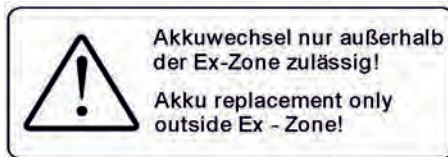

4 Special safety and Precautionary Measures

When working with the NIVUS equipment, the following safety and precautionary measures must be observed and followed generally and at all times. These warnings and notes are not repeated for each description within the document.

WARNING



Check danger due to explosive gases

Before starting assembly, installation and maintenance work, be sure to check that all regulations on safety at work have been observed and that there is no possible risk of explosive gases. Use a gas warner for the check.

When working in the sewer system, make sure that no electrostatic charge can occur:

- Avoid unnecessary movements to reduce the building-up of static charges.
- Discharge any static electricity present on your body before you start installing the sensor.

Disregarding may result in personal injury or damage to the system.

WARNING



Germ Contamination

Due to the frequent use of the sensors in the waste water sector, parts can be contaminated with dangerous germs. Therefore, appropriate precautions must be taken when coming into contact with cables and sensors.

Wear protective clothing.

WARNING



Observe Occupational Safety Regulations!

Before and during mounting works, compliance with all work safety regulations must always be ensured.

Disregarding may lead to personal injury.

WARNING



Do not disable Safety Devices!

It is strictly forbidden to disable the safety devices or to change their mode of operation.

Disregarding may result in personal injury or damage to the system.

WARNING



Disconnect the System from Mains Power

Disconnect the system from the mains power before starting maintenance, cleaning and/or repair work (only by qualified personnel).

Disregarding may lead to electric shock.



Commissioning only by qualified Personnel

The entire measuring system may only be installed and commissioned by qualified personnel.

Built-In Buffer Battery

The backup battery integrated in the measuring instrument may only be replaced by NIVUS or personnel authorised by NIVUS. Otherwise the warranty becomes void.

WARNING

In case of contact with sulphuric acid, rinse immediately with plenty of water

Rechargeable/battery blocks contain sulphuric acid. In case of contact, rinse immediately with plenty of water.

Disregarding may lead to personal injury.

5 Warranty

The device was functionally tested prior to shipping. When used for the intended purpose (see Chap. "7 Intended Use") and in compliance with the instruction manual, the applicable (see Chap. "1.1 Applicable Documentation") and the safety information and instructions contained therein, no functional restrictions are to be expected and flawless operation should be possible.



Please also refer to the following chapter "6 Disclaimer".



Limitation of Warranty

In case of disregarding the safety notes and instructions in this document, the companies of the NIVUS-Group reserve the right to limit the warranty.

6 Disclaimer

The companies of the NIVUS-Group assume no liability

- for consequential damages resulting from a **change** in this document. The companies of the NIVUS-Group reserve the right to change the contents of the document including this disclaimer without prior notice.
- for personal injury or damage to property resulting from **failure to comply** with the **applicable regulations**. For connection, commissioning and operation of the sensors, all information and higher-level legal regulations of the country (in Germany e.g. the VDE regulations), such as valid Ex regulations as well as the safety and accident prevention regulations applicable to the respective individual case shall be observed.
- for personal injury or damage to property resulting from **improper handling**. For safety and warranty reasons, all work on the equipment that goes beyond the installation and connection measures may only be carried out by NIVUS personnel or by persons or companies authorised by NIVUS.
- for personal injury or damage to property resulting from the operation of the equipment in a **technically faulty** condition.
- for personal injury or damage to property resulting from **improper use**.
- for personal injury or damage to property resulting from failure to observe the **safety instructions** in this instruction manual.
- for missing or incorrect readings due to **improper installation** and for any consequential damage resulting therefrom.

7 Intended Use



Note

The device is intended exclusively for the purpose mentioned below. Any other use beyond this, any conversion or modification of the instrument without written agreement with the companies of the NIVUS-Group is considered improper use.

The companies of the NIVUS-Group are not liable for any damage resulting from this. The operator alone bears the risk.

The transmitter NivuFlow Mobile 750 incl. associated sensors is designed for temporary flow measurement of slightly to heavily polluted media in open channels and part filled and full pipes.

The NivuFlow Mobile 750 is designed and produced according to the current state of the art and the recognised safety rules at the time of publication of this document. Nevertheless, risks of personal injury or damage to property cannot be completely ruled out.

The permissible maximum limit values in Chapter "18 Technische Daten" must be observed. All cases of use deviating from these limit values, which have not been approved by NIVUS GmbH in writing, are excluded from the liability of the NIVUS-Group.

8 Ex Protection

The portable transmitter NivuFlow Mobile 750 incl. associated sensors is designed for use in areas with explosive atmospheres of zone 1.

The following conditions must be observed:

- programming the device under Ex conditions is permissible:
 - with the programmer **inside** the Ex-area, provided that the display and control unit used has an Ex-approval
 - with the programmer **outside** the Ex-area, when the display and control unit used has no Ex-approval
- Maintenance and repair shall only be carried out **outside** the Ex area
- Rechargeable battery blocks may only be removed/installed and charged **outside** the Ex area
- in general, only battery blocks approved by NIVUS may be used **within** the Ex area
- the USB interface is only permitted to be used **outside** the Ex area
- the SIM card may only be exchanged **outside** the Ex area
- the device must be secured (after installation at the measurement place) with the pad-lock against unauthorised opening (holes on the side of the housing)

Approvals for Transmitter and Sensors

 See Chap. "18 Specifications".



Validity of the Ex Approval

The Ex approval is only valid in conjunction with the corresponding marking on the name-plate of transmitter and the sensors.



Declarations of Conformity and Test Certificates

For installation and commissioning, the EU declarations of conformity and test certificates of the approving body must be strictly observed.



Ex Approval for Sensors

The Ex approval of the sensors is enclosed with the technical description for cross correlation and Doppler sensors.

9 Duties of the Operator



Important Note

In the EEA (European Economic Area), the national transposition of the Framework Directive (89/391/EEC) as well as the associated individual directives and, in particular, the Directive (2009/104/EC) concerning the minimum safety and health requirements for the use of work equipment by workers at work, as amended, must be observed and complied with.

In Germany, the Ordinance on Industrial Safety and Health must be complied with.

Obtain the local operating licence and observe the associated conditions. In addition, you must comply with environmental protection requirements and local legal requirements for the following:

- Safety of personnel (accident prevention regulations)
- Safety of work equipment (protective equipment and maintenance)
- Product Disposal (Waste Management Act)
- Materials Disposal (Waste Management Act)
- Cleaning (Cleaning Agents and Disposal)

Connections

As the operator, before activating the device, make sure that the local regulations (e.g. for the electrical connection) have been observed during installation and commissioning.

Keep the Instruction Manual for future Reference

Keep the instruction manual in a safe place and ensure that it is always available and can be consulted by the user of the product.

Hand over the Instruction Manual

When selling the transmitter, this instruction manual must be handed over with it. The manual is part of the standard delivery.

10 Requirements for the Personnel

Installation, commissioning and maintenance may only be carried out by personnel who fulfil the following conditions:

- Qualified personnel with appropriate training
- Authorisation by plant operator



Qualified Personnel

in the sense of these instructions or the warnings on the product itself are persons who are familiar with the installation, assembly, commissioning and operation of the product and who have the qualifications appropriate to their job, such as

- I. training and instruction or authorisation to switch circuits and devices/systems on and off, to earth and to label them in accordance with the standards of safety technology.*
- II. Training or instruction in accordance with safety technology standards in maintenance and use of appropriate safety equipment.*
- III. First Aid Training*

Delivery, Storage and Transport

11 Scope of Delivery

The standard delivery of the NivuFlow Mobile 750 comprises:

- Transmitter Type NivuFlow Mobile 750 (according to delivery documents)
- Ring magnet *ZUB0 NFM MAGNET* (Fig. 2-3)
- USB Stick
- Screwdriver for hexagon socket screws
- PU adhesive plates (two pieces; 31x17x3.5 mm) to avoid negative pressure in the case of a possible return (by air freight) to NIVUS (e.g. for maintenance)
- T-shape antenna (only for versions with internal 2G/3G/4G modem)
- Padlock (only for Ex versions)
- Instruction manual with EU Declaration(s) of Conformity (printed copy or as link to the NIVUS download centre); It includes all information required for the operation of the NivuFlow Mobile.

Check additional accessories according to the order against the delivery note.

12 Inspection upon Receipt

Check the delivery for completeness and apparent intactness immediately after receipt. Report any transport damage immediately to the delivering carrier. Also send a written report to NIVUS GmbH in Eppingen.

Incomplete deliveries must be addressed in writing within two weeks to your responsible representative or directly to the head office in Eppingen.



Observe the two-week deadline

Complaints received later will not be recognised.

➡ Before the first use:

1. Open the enclosure cover.
2. If present, remove the PU adhesive plates (two pieces; 31x17x3.5 mm) on the right and left of the enclosure frame. (Fig. 15-1 Pos. 1). These were fitted prior to shipment (for air freight) to prevent the enclosure from closing and to eliminate the formation of vacuum in the event of extreme temperature fluctuations during the shipping phase.

13 Storage

Observe the minimum and maximum values for external conditions such as temperature and humidity according to Chapter "18 Specifications".

Protect the instrument from corrosive or organic solvent vapours, radioactive radiation and strong electromagnetic radiation.

➡ To store the device:

1. Remove rechargeable battery blocks.
2. If the hoop guards for mounting the Connector Box are fitted, remove them (if space is limited) and fit the rubber buffers instead.



Rubber buffers

Be sure to screw on the rubber buffers,

- *so that the concealed screw-on plates on the back of the NFM do not get lost inside the screw-on channels; the screw-on plates are indispensable as they contain the fastening threads for the protective brackets and additionally serve to stabilise them on the NFM;*
- *because the rubber buffers are designed as shock protection for the NFM connections and protect them from possible damage.*

14 Transport

Protect the NivuFlow Mobile from strong impacts, blows, shocks or vibrations by using appropriate safety measures such as straps or similar.

Otherwise, the same conditions apply with regard to external influences as for storage (see Chap. "13 Storage").

15 Return

In the event of a return, send the unit to NIVUS GmbH in Eppingen carriage paid and in the original packaging.

Items that have not been sufficiently franked will not be accepted!

➡ Before shipment (for air freight):

1. Stick the PU adhesive plates (two pieces; 31x17x3.5 mm) on the right and left of the enclosure frame (Fig. 15-1 Pos. 1). This measure prevents the enclosure from closing and excludes vacuum formation during extreme temperature fluctuations.
2. For transport, place the NivuFlow Mobile safely in the original packaging.

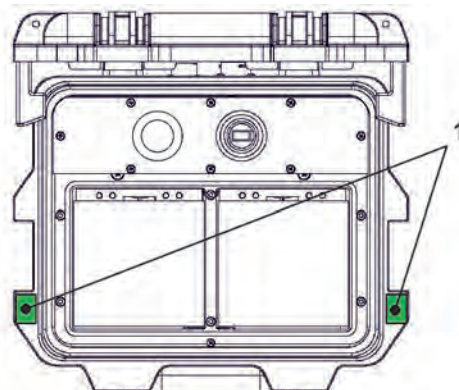
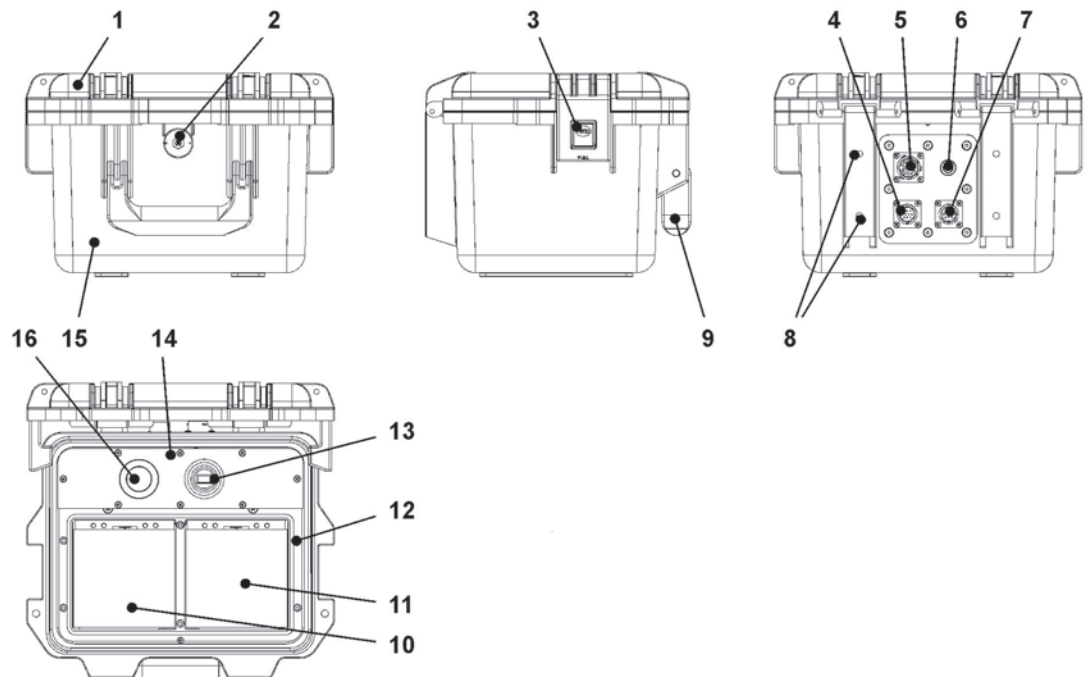

Fig. 15-1 Position to stick on the PU adhesive plates

Product Description

16 Product Construction and Overview



- 1 Enclosure cover
- 2 LED (status display) and Reed contact (wake-up via magnet)
- 3 Lock (both sides)
- 4 Sensor socket v2/h
- 5 Multifunction socket I/O
- 6 2G/3G/4G Antenna socket
- 7 Sensor socket v1
- 8 Mounting holes for spacer buffers or hoop guards
- 9 Carrying handle
- 10 Left insertion compartment for rechargeable battery block
- 11 Right insertion compartment for rechargeable battery block (possible charging position for battery block)
- 12 Cover (not shown) over battery block with six captive hexagon socket screws
- 13 USB-A Interface
- 14 Transmitter NivuFlow Mobile 750 (IP67)
- 15 Enclosure (IP68 with closed enclosure cover)
- 16 GPRS SIM card slot (in connection with 2G/3G/4G antenna)

Fig. 16-1 Device construction NivuFlow Mobile 750 with enclosure

16.1 Enclosure dimensions

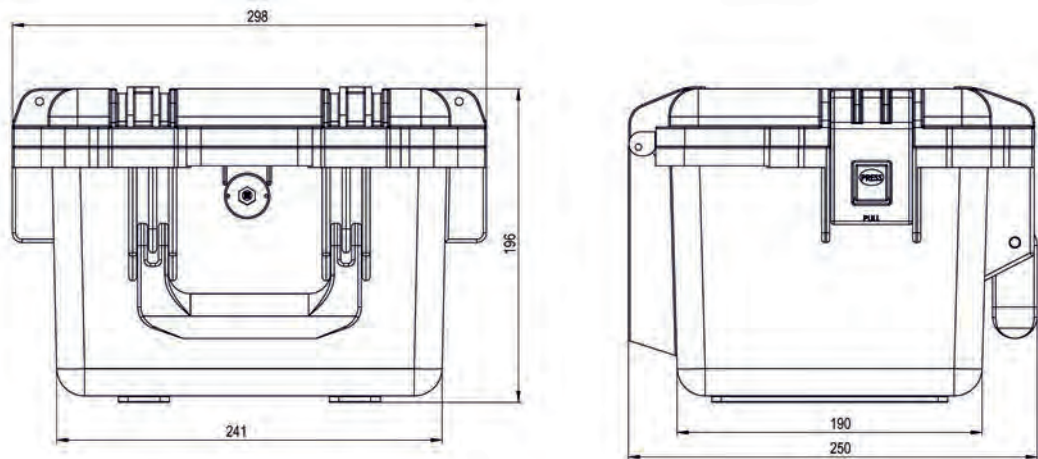
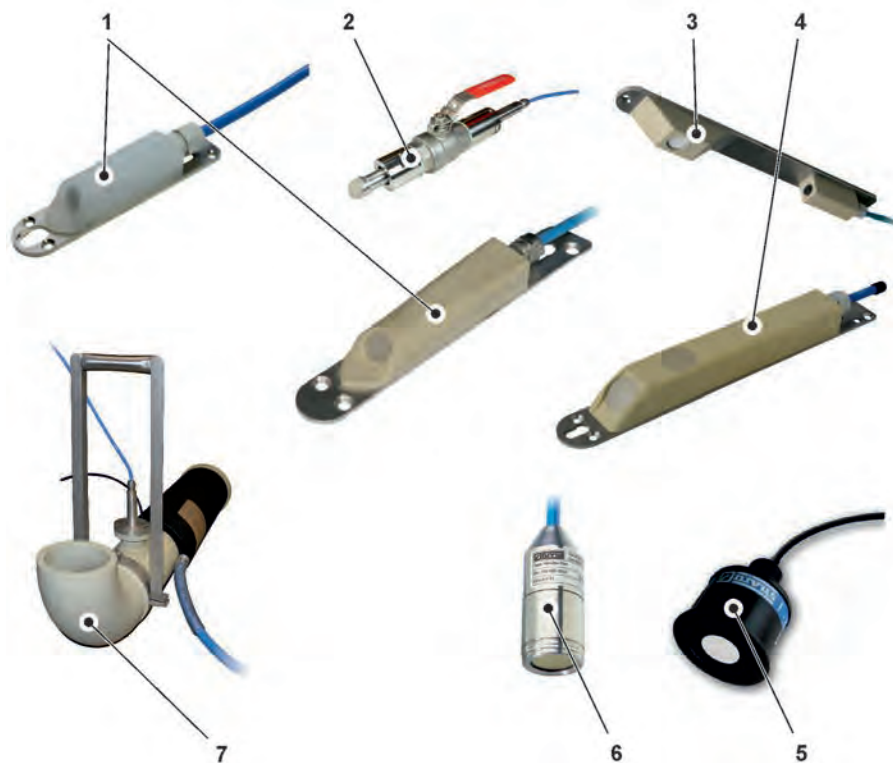

Fig. 16-2 Enclosure

16.2 Connectable Sensors/Devices

In the following illustration you will find an overview of the connectable sensors.



- 1 CSM Flow velocity wedge sensor
- 2 CSM Flow velocity pipe sensor
- 3 DSM-L0 Level wedge sensor
- 4 CSP Flow velocity/combi wedge sensor
- 5 i-Series Level sensor
- 6 HSB0 NBP Immersive probe for level measurement
- 7 NPP Pipe measuring section

Fig. 16-3 Connectable Sensors/Devices

17 Device ID

The information in this instruction manual only applies to the device type indicated on the title page. The nameplates are attached to the side of the enclosure and contain the following information:

- Name and address NIVUS GmbH
- CE label
- Marking of the series and type with article number and serial number
- Year of manufacture: the first four digits of the serial number refer to the year of manufacture and the week number (2133.....)
- Ex Protection Label
- Ambient conditions in operation

It is important for all queries and spare parts orders that the article number and serial number of the respective device are specified correctly. This is the only way to ensure proper and fast processing.



Fig. 17-1 Nameplate (Part 1) NivuFlow Mobile 750 (Example Ex Device)

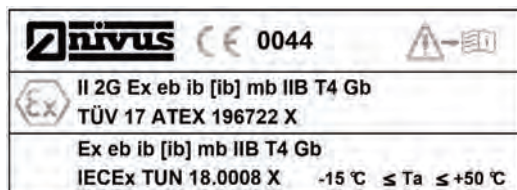

Fig. 17-2 Nameplate (Part 2, only for Ex Devices) NivuFlow Mobile 750





Check nameplates

Check by means of the nameplates whether the supplied device corresponds with your order.



The EU Declarations of Conformity and the EU Type Examination Certificate(s) can be found at the end of this instruction manual.

18 Specifications

Measurement Principles	<ul style="list-style-type: none"> - Flow velocity measurement by means of high accurate, spatially allocated ultrasonic cross correlation - Level measurement depending on sensor type via air or water ultrasonic transit time measurement, pressure probe or mA input for level measurement (2-wire level sensor)
Power Supply, internal	1...2x Rechargeable battery block 12 V / 14 Ah, VRLA-AGM
Enclosure	<ul style="list-style-type: none"> - Material: HPX high-performance synthetic resin - Weight: approx. 4.7 kg (without rechargeable blocks and hoop guards) - Protection: IP68 closed / IP67 with open enclosure cover
Ex Approvals (option) / other Approvals (option)	<p>Transmitter:</p> <ul style="list-style-type: none"> - ATEX: TÜV 17 ATEX 196722 X - IECEx: TUN18.0008X <p> II 2G Ex eb ib [ib] mb IIB T4 Gb</p> <p>Sensors:</p> <ul style="list-style-type: none"> - ATEX: TÜV 12 ATEX 087812 <p> II 2G Ex ib IIB T4 Gb</p>
Operation Temperature	-15 °C...+50 °C
Permanent Storage Temperature	-15 °C...+45 °C
Max. Humidity	90 %, non-condensing
Indication	Status LED (RGB)
Operation	Magnet switch; via WLAN with display and operating module (smartphone, tablet, notebook etc.)
Inputs	<ul style="list-style-type: none"> - 2x 0/4...20 mA (active/passive) - 1x 0/4...20 mA (passive) - 1x active digital input - 1x Connection socket for power adapter or alternative power supply
Outputs	<ul style="list-style-type: none"> - 1x Analogue output 0...5 V / 0...10 V - 1x potential-free digital output as SPDT / bistable - 1x USB-A for read-out of measurement values via USB stick
External Power Supply / Charging Socket with Rechargeable Battery Block	1x Connection socket for power adapter or alternative power supply
Storage Cycle	5 sec. to 60 min., time-cyclical or event-dependent
Data Memory	Internal; 182.398 measurement cycles
Data Transmission/ Communication	<ul style="list-style-type: none"> - Via plug-in USB stick - Via WLAN - Option: via 2G/3G/4G

Charger	<ul style="list-style-type: none"> - Input voltage 100...240 V AC / 50...60 Hz / 50 VA - Protection Class II - Overvoltage Category II - Pollution Degree 2 - Ambient Temperature 0 °C...+40 °C
----------------	--

Tab. 2 Specifications

Sensors



The structure and description of the associated sensors as well as their technical data can be found in the corresponding instructions or technical descriptions.

19 Equipment

19.1 Device Versions

The portable transmitter is manufactured in different versions. The table below provides an overview on the different versions.

The exact device type can be specified by means of the article number.

NFM-	Version	
	07500	Portable flow transmitter for open channels and part filled or full pipes; function extension via software licences
	000	Standard device
	E00	With ATEX Approval, Zone 1
	0750G	Portable flow transmitter for open channels and part filled or full pipes; with remote data transmission, function extension via software licences
	0E0	With internal modem; modem card Europe* ¹ ; with T-Shape Antenna (<i>NFM0 Z ANT1</i>)
	0G0	With internal modem; modem card Global* ² ; with T-Shape Antenna (<i>NFM0 Z ANT1</i>)
	0EG	With internal modem; modem card Europe* ¹ ; with T-Shape Antenna (<i>NFM0 Z ANT1</i>) Including NIVUS Connectivity
	0GG	With internal modem; modem card Global* ² ; with T-Shape Antenna (<i>NFM0 Z ANT1</i>) Including NIVUS Connectivity
	EE0	With ATEX Approval, Zone 1 With internal modem; modem card Europe* ¹ ; with T-Shape Antenna (<i>NFM0 Z ANT1</i>)
	EG0	With ATEX Approval, Zone 1 With internal modem; modem card Global* ² ; with T-Shape Antenna (<i>NFM0 Z ANT1</i>)
	EEG	With ATEX Approval, Zone 1 With internal modem; modem card Europe* ¹ ; with T-Shape Antenna (<i>NFM0 Z ANT1</i>) Including NIVUS Connectivity

		EGG	With ATEX Approval, Zone 1 With internal modem; modem card Global ^{*2} ; with T-Shape Antenna (<i>NFM0 Z ANT1</i>) Including NIVUS Connectivity
NFM-			

*1 Areas of use: Europe, Middle East, Africa, Korea, Thailand, India

*2 Areas of use: Global

Tab. 3 Product Structure NFM 750

⇒ Accessories see Chapter "58 Accessories".

19.2 Add-On Function Licences

The transmitter can be equipped with supplementary functions at extra charge. The following function extensions are currently available as (software) licences:

- FTP/SMTP client for data transmission via FTP server (*NFM LIZENZ FTP*), see Chap. "42 Parameter Menu Communication": **>FTP< / >E-Mail<**
- Data transmission extended to determine the data depth (*NFM LIZENZ ERW*) see Chap. "40.3 Menu Data Memory": **>Data Depth<**
- Data transmission expert to determine the data depth (*NFM LIZENZ EXP*) see Chap. "40.3 Menu Data Memory": **>Data Depth<**

⇒ The functions are activated according to Chap. "41.5.5 Feature Unlock".

Function Description

20 Areas of Use

The NivuFlow Mobile 750 is a portable measuring system for flow measurement. The NivuFlow Mobile is designed mainly for use in the measurement of slightly to heavily contaminated, aqueous liquids of the most varied compositions.

It is used in part filled and full flumes, channels and pipes of the most varied geometries and dimensions.

An overview on connectable sensors/probes can be found in Chapter "16.2 Connectable Sensors/Devices".

21 Functional Principles

21.1 Flow Velocity Measurement

21.1.1 Cross Correlation



Note on the Ultrasound Reflection Principle

The flow velocity measurement method is based on the ultrasound reflection principle. Therefore, it is indispensable for the function of the system that particles (dirt particles, gas bubbles or similar) are present in the water. These particles reflect the ultrasonic signal emitted by the sensor.

The transducer, which is inclined in the direction of flow, works as a velocity sensor. For this purpose, a short ultrasonic signal beam is irradiated into the measurement medium at a defined angle. All particles in the measurement path (air, dirt particles, suspended particles) reflect parts of the ultrasonic signal. Depending on the size and shape of the particle, this produces a special ultrasonic reflection signal.

The multitude of reflected signals results in a reflection pattern (see Fig. 21-1). This pattern is received back by the transducer, converted into electrical signals and loaded into a digital signal processor (DSP) contained in the sensor.

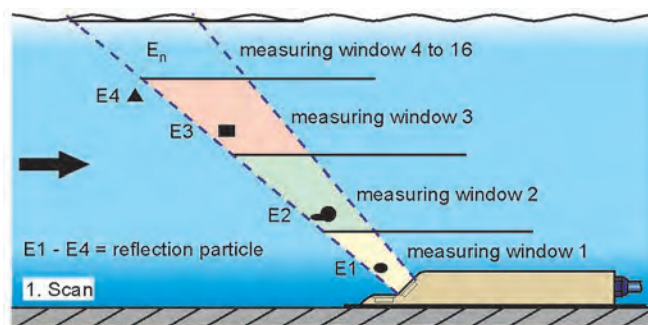

Fig. 21-1 Situation at first signal reception

After a defined time, a second ultrasonic pulse is irradiated into the medium. The newly received reflection signal is also loaded into the DSP.

Different flow velocities prevail at different flow heights (flow velocity profile).

The reflecting particles have thus moved on to different distances from the first measurement point, depending on their height. This creates a shifted image of the reflection pattern (see Fig. 21-2).

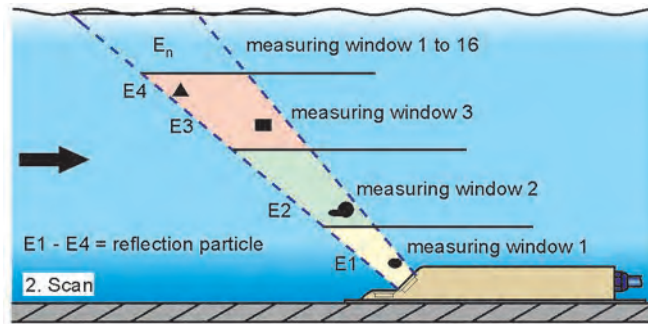

Fig. 21-2 Situation at second signal reception

The two reflection patterns are checked for their similarities in the DSP using cross-correlation methods. All signals that cannot be clearly identified (new particles, rotated particles) are discarded, leaving two shifted signal patterns that are similar to each other.

Up to 16 measurement windows are overlaid on these two images, depending on the previously performed height measurement.

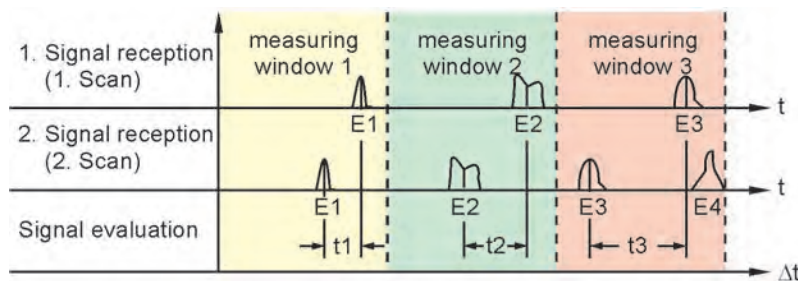

Fig. 21-3 Echo signal formation and evaluation

The flow velocity is determined in each measurement window on the basis of the transmission angle, the temporal distance between the two transmission signals and the difference in the signal pattern.

The mathematical stringing together of the individual calculated flow velocities results in the velocity profile of the acoustic path.

This measured velocity profile is shown directly in the display of the NivuFlow.

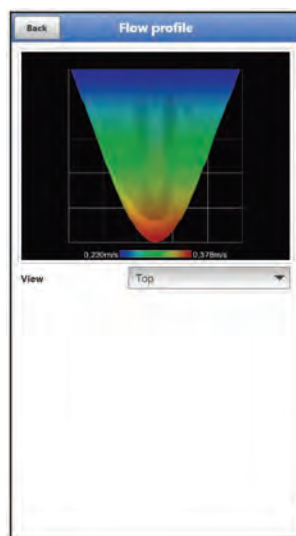

Fig. 21-4 Measured flow profile in the display

If the calming distance at the measuring point is sufficient, a three-dimensional flow distribution (see Fig. 21-4) can be calculated. This is based on the geometric data of the channel and the velocity distribution.

For asymmetrical flow profiles or structured profiles, the use of several flow velocity sensors is recommended. The positions of the sensors entered in the transmitter are thereby taken into account with their individual vertical V-profile in the 3D overall profile and also displayed.

Based on the positions of the measured gate velocities and taking into account the channel shape and dimensions, the exact flow rate is calculated, displayed and output by means of scientifically determined hydraulic models stored in the device.

21.2 Level Measurement

21.2.1 2-wire Level Sensor

For level measurement, 4...20 mA 2-wire sensors can be connected to the data NFM directly or via a junction box, which are supplied by the NivuFlow Mobile 750 (e.g. NivuBar Plus or i-Series sensor).



Measurement Ranges of i-Series Sensors

The i-Series sensors have pre-programmed measurement ranges. Observe the exact specifications in the instruction manual for i-Series sensors.

The i-Sensor can also be put into operation without a HART modem.

Enter the max. possible measuring span of the sensor in the "Value at 20 mA" parameter. Depending on the mounting height of the sensor, a negative offset must also be set.

	i-3	i-6	i-10	i-15
Distance to sensor face in [m] at 4 mA (empty) 0 %	3.0	6.0	10.0	15.0
Distance to sensor face in [m] at 20 mA (full) 100 %	0.125	0.300	0.300	0.500
Max. possible measurement span (value at 20 mA) in [m]	2.875	5.7	9.7	14.5

Tab. 4 Measurement Span of i-Series Sensoren

21.2.2 Water-Ultrasound

The sensors type CSP-V2H1 and CSP-V2U1 are equipped with a horizontal transducer for level measurement according to the water-ultrasonic transit time method.

The time between sending and receiving an impulse reflecting on the water surface is measured.

$$h_1 = \frac{1}{2} \times (c \times t_1)$$

- with:
 - h = Filling Level
 - c = Sound Transit Time
 - t₁ = Time between transmit and receive signal

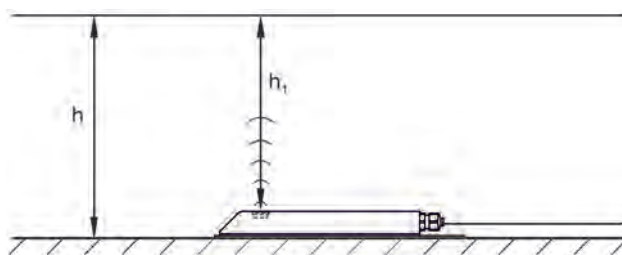

Fig. 21-5 Determined level

At a medium temperature of 20 °C, the sound transit time in water is 1480 m/s.

The temperature-dependent deviation is 0.23 % per Kelvin.

In order to realise a level measurement accurate to the millimetre, the medium temperature is therefore permanently determined. With the determined temperature, the sound propagation time is corrected for calculation.

The fixed height value is added to the determined value h_1 . This results in the total flow height h .

21.2.3 Air-Ultrasound

The level measurement via air ultrasound is carried out from above using a non-contact air ultrasonic sensor type DSM-L0. This sensor is used for the measurement of low levels. The level sensor must be installed exactly in the middle of the channel crown, ($\pm 2^\circ$) parallel to the water surface.

Analogous to the water-ultrasonic transit time method, a signal is sent, but here through the air in the direction of the water surface, and reflected from there. The measured transit time gives the distance of the sensor to the water surface and thus the level of the medium.

Since the air temperature can lead to deviations in the transit time, this is determined and included in the internal calculation by the transmitter.

21.2.4 Pressure

The sensor CSM-V1D0 generally works with a hydrostatic level measurement and the CSP-V2D0/V2U1 sensors can optionally be equipped with an additional hydrostatic level measurement.

The piezoresistive pressure sensor works according to the relative pressure principle. The pressure of the stationary water column above the sensor is, depending on the density of the liquid, directly proportional to the filling level. Fluctuations in atmospheric air pressure are compensated for using a little air tube. This air tube is integrated in the sensor cable. The pressure sensor makes it possible to determine the flow height even if the sensor is installed off-centre (to the canal bottom).

The pressure sensor is calibrated during commissioning by entering a manually determined reference value. The height due to sensor mounting is also added.

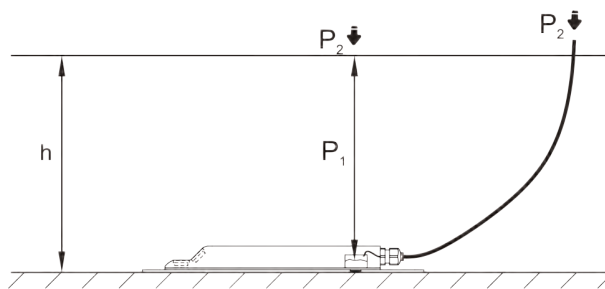

Fig. 21-6 Determined level

Installation and Connection

22 General Installation Information

WARNING



Check danger due to explosive gases

Before starting assembly, installation and maintenance work, be sure to check that all regulations on safety at work have been observed and that there is no possible risk of explosive gases. Use a gas warner for the check.

When working in the sewer system, make sure that no electrostatic charge can occur:

- *Avoid unnecessary movements to reduce the building-up of static charges.*
- *Discharge any static electricity present on your body before you start installing the sensor.*

Disregarding may result in personal injury or damage to the system.

22.1 Mounting Place

The following precautions must be taken at the mounting place for safe installation:

- ➡ Protect the transmitter from direct sunlight. If necessary install a sunshade.
- ➡ Observe the permissible ambient temperature (see Chap. "18 Specifications").
- ➡ Do not expose the transmitter and the connected sensors to strong vibrations or mechanical shocks.

Necessarily avoid when selecting the mounting place:

- Corrosive chemicals or gases
- Radioactive radiation
- Installation close to footpaths or travel ways

22.2 Before Installation

CAUTION



Rope down the instrument only with suitable safety belts

The instrument may only be lowered into shafts using the carrying handle and suitable straps, ropes or similar.

Lowering the unit by the sensor cable is not permitted and can lead to cable breakage, leaking plug connection or tearing off the transmitter.

22.2.1 PU Adhesive Plates on the Enclosure Frame

- ➡ Before using the NivuFlow Mobile 750 for the first time, make sure that the PU adhesive plates on the enclosure frame have already been removed. If not, remove and clean the enclosure frame if necessary.

➡ See Chapter "12 Inspection upon Receipt".

22.2.2 Gaskets

- ➡ Check the gaskets on the enclosure cover.
Before closing the enclosure cover, make absolutely sure that the gasket is clean and undamaged. Therefore:

1. Remove foreign bodies and dirt.

2. Replace defective gaskets.
3. Treat the seals with silicone grease if necessary.



Gaskets

Damage to equipment caused by leaking or defective gaskets shall be excluded from the liability of the companies of NIVUS GmbH.



See also Chap. "54.2 Maintenance Tasks".

22.2.3 Securing the Instrument

- Secure the transmitter against being washed away.
When installing the transmitter in shafts or channels that are at risk of flooding, it must be secured against being washed away unintentionally (use a suspension bracket, plastic/stainless steel cable, chain or similar).

22.2.4 Connection Sockets

- Screw open, unused connection sockets on the back of the instrument with the attached covers to protect against dirt or against impacts before installation.

The protection class of the (closed) device is IP68 even with open connection sockets.
Damaged or lost covers can be reordered from NIVUS at extra costs.

22.2.5 Padlock

- Secure the transmitter for operation in Ex areas with the supplied padlock for compliance with the legal requirements (see EU Declaration of Conformity).

If a transmitter is already suitably protected in another way, the padlock can be dispensed with. The responsibility for this lies with the operator.

23 Electrical Installation/Power Supply

23.1 General Information on the Power Supply

WARNING



Danger by electric voltage

Remove the rechargeable battery blocks from the device. If currently there is connection to the mains via the multifunction socket, disconnect it.

When working on the electrical connections, there is a risk of electric shock. Observe the electrical data given on the nameplate.

Disregarding may lead to personal injury.



Note

Observe the national installation instructions.

- Make sure that the following requirements are met:
 1. Please note that installation may only be carried out by qualified personnel.
 2. For the electrical installation, comply with the legal regulations of the respective country (such as VDE 0100 in Germany).

3. Follow further (country-specific) legal standards, regulations and technical codes.
4. Complete the installation of the transmitter and the sensors before applying the operating voltage. Check whether the installation is correct.

⇒ You can find a description on how to connect the sensors starting on page 40.

CAUTION



Do no loosen screws

Do not loosen any screws on the transmitter other than the captive hexagon socket screws of the battery compartment cover!

Keep the battery compartment closed during operation.

23.2 Rechargeable Battery Block

The NivuFlow Mobile can be operated with only one rechargeable battery block, but two battery blocks are recommended for transmitter operation to ensure the maximum possible battery life.

⇒ Rechargeable battery blocks can be purchased from NIVUS (see Chap. "58 Accessories").

The rechargeable battery is placed in the battery compartment. A second slot is provided directly next to it for a second battery block. Which slot is used when using only one rechargeable battery is freely selectable, but restrictions must be expected in charging mode:

- In **charging mode**, only the battery block in the right-hand slot is charged and only up to approx. 75 %.
- In **battery mode**, the battery block with the higher charge level (regardless of the slot) is used until both are at the same voltage level, then both are used simultaneously.

In addition, in the menu >Battery (12V)< the battery type used or the number of rechargeable batteries installed should be entered so that the remaining battery power is correctly displayed in the menu >System< / >Information<.

The battery compartment is closed with a cover and six captive hexagon socket screws.



Installation of Spare Parts / Wearing Parts

The use of spare/wear parts (e.g. rechargeable battery blocks) that are not approved by NIVUS is generally not permitted.

Non-compliance may have negative consequences in terms of warranty and liability. See Chap. "5 Warranty" and "6 Disclaimer".

WARNING



Do not modify batteries or expose them to fire

Do not disassemble, modify or damage the rechargeable batteries to avoid leakage, fire or explosion.

Do not heat the batteries above 50 °C and avoid contact with open fire.

Disregarding may lead to personal injury.

23.2.1 Removing/installing the battery block

WARNING



Risk of explosion when removing/installing the battery block in Ex areas

The battery pack may **only** be removed/installed **outside** the Ex area. **Never within** Ex areas.

When removing the battery block, make sure that the poles are not short-circuited by an external object. This could cause very high short-circuit currents to flow, which could lead to excessive heat or fire and destruction of the rechargeable battery block.

Observe the specifications on the rechargeable battery block.

The battery pack can also be replaced in wet weather and rain. The battery compartment is completely separate from the electronic part of the transmitter.

➡ Procedure:

1. Loosen the six captive hexagon socket screws of the cover.
2. Remove the cover.
3. Take out the inserted battery pack on the grip strap.
4. When refitting the battery block, put on the cover and hand-tighten the captive hexagon socket screws of the cover.

23.2.2 Charging the battery block

The battery pack is usually delivered empty and must be charged **before first use**.

NIVUS recommends charging outside the unit via the mains adapter/charger to ensure 100 % charging performance. When installed, the battery pack is only charged up to approx. 75 %.

WARNING



Risk of explosion when removing/installing and charging the battery block in Ex areas

The battery pack may **only** be removed/installed and charged **outside** the Ex area. **Never within** the Ex area, as explosion protection is not guaranteed here.



Power Adapter/Charger

Only the mains adapter/charger (Fig. 23-1 Pos. 1; NFM0 ZLAD) (available at a charge from NIVUS GmbH) may be used to charge the battery pack. Observe the specifications on the power adapter/charger.

Permissible charging temperature for the rechargeable battery block VRLA-AGM: 0...+40 °C

The use of chargers of other types can lead to the destruction of the rechargeable battery (e.g. through cell leakage, explosion, etc.).



- 1 Power adapter/charger with connection cable for the multifunction socket on the NFM or charging tray
- 2 Indicator LED for charging status

Fig. 23-1 Power adapter/charger

Before connecting or disconnecting the power pack/charger (Fig. 23-1 Pos. 1) to or from a battery pack, disconnect it from the mains voltage.

The charging status is indicated with the built-in LED (Fig. 23-1 Pos. 2).

Light colour/indication	Meaning
Yellow	The rechargeable battery is being charged
Green	Trickle charge
LED not lit	Reverse polarity, short circuit or no mains connection; fuse in the unit has blown *1

Tab. 5 Light colours of the LED

*1) If the condition persists, contact the NIVUS customer service (see Chap. "54.3 Customer Service Information").

Charging the inserted battery block

See Chapter "23.2.4 Operation/Charging with direct connection to mains power".

Charging the removed battery block

➡ Procedure:

1. Place the charging tray in a protected, dry place on a stable, horizontal surface. Make sure that the charging tray itself is also dry.
2. Take appropriate measures to ensure that no unauthorised persons have access to the units during the charging process.
3. Insert the rechargeable battery (Fig. 23-2 Pos. 1) upside down into the charging tray (Fig. 23-2 Pos. 2).
4. Connect the power adapter/charger (with connection cable for the multifunction socket) via the charging socket (Fig. 23-2 Pos. 3) and connect to the mains voltage. The battery block is charged via the charging contacts (Fig. 23-2 Pos. 4). Note the light colour/indication of the LED on the power adapter/charger.
5. At the end of the charging process, to avoid a short circuit at the charging contacts/poles, first disconnect the power adapter/charger from the mains voltage, then remove the battery pack.

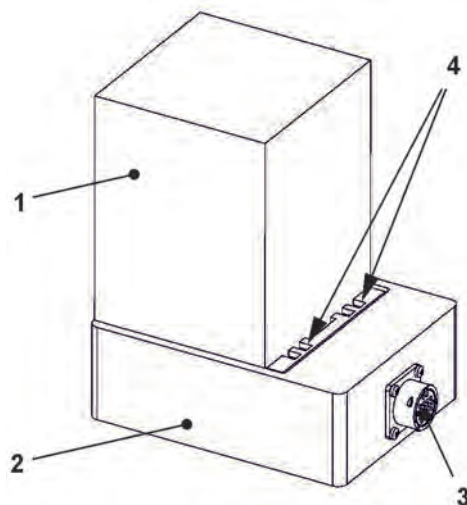

- 1 Rechargeable battery (inserted upside down)
- 2 Charging tray
- 3 Charging socket to connect the power adapter/charger

4 Charging contacts

Fig. 23-2 Battery block in the charging tray

Over time, the battery loses its maximum capacity. This affects the battery life, which cannot be taken into account by the battery life calculation integrated in the NivuFlow Mobile. At high or low ambient temperatures as well as longer service life, the capacity of the battery block used is reduced.

Tips to extend battery life

- *Store the battery at room temperature:*
 - *Higher temperatures lead to faster battery ageing.*
 - *Lower temperatures lead to a loss of capacity.*
- *Store battery fully charged; fully charge every 6...12 months.*
- *Keep the rechargeable battery clean (dust-free) and dry.*



Battery Life

Rechargeable battery blocks are wearing parts and must be replaced when the charging capacity decreases significantly. The battery life depends on the frequency of use.

Note the previous "Tips to extend battery life".

Measurement

The battery should be charged before each NivuFlow Mobile measurement.

Unused battery packs must be removed from the battery compartment after the last measurement and stored in a dry, frost-free room (see also "Tips to extend battery life").

Installation of Spare Parts / Wearing Parts

The use of spare/wear parts (e.g. rechargeable batteries) that are not approved by NIVUS will invalidate the warranty.

Disposal of the battery block

Always ensure that the battery blocks are disposed of in an environmentally friendly manner.

Used battery packs can be returned to the manufacturer or handed in at suitable collection points.

23.2.3 Operation/charging via an alternative voltage source

WARNING



Risk of explosion when charging the battery pack in Ex areas

*The battery pack may **only** be removed/installed and charged **outside** the Ex area. **Never within** Ex areas.*

The NivuFlow Mobile can also be powered by alternative voltage sources (e.g. external rechargeable batteries, solar panels, supply via an external power supply unit) via the multifunction socket.

WARNING



Explosion hazard during operation with direct external power supply in Ex areas

The unit may **only** be operated **outside** the Ex area with direct **external** power supply. **Never within Ex areas.**

In addition to operation, the battery block in the right-hand slot is also charged here. However, only up to approx. 75 % of the total charging power, which is why NIVUS recommends using the charging tray for charging the battery block (see chapter "23.2.2 Charging the battery block").

NIVUS offers a special 2-core connection cable (*NFM0 ZVER PS*) for the alternative power supply with open cable ends on one side and plug for the multifunction socket on the other side.

The voltage input on the NivuFlow Mobile operates from 12...14.5 V and is protected against short-term overvoltage, overcurrent and reverse polarity.



Battery slots when charging/discharging

In **charging mode**, only the battery block in the right-hand slot is charged.

In **battery mode** of the rechargeable battery blocks, the battery block with the higher charge level (regardless of the slot) is used until both are at the same voltage level, then both are used simultaneously.

23.2.4 Operation/Charging with direct connection to mains power

The NivuFlow Mobile can also be operated directly on a mains voltage of 100...240 V AC by means of the combined power supply unit/charger (see Fig. 23-1).

WARNING



Explosion hazard during operation with direct mains power connection in Ex areas

The unit may **only** be operated **outside** the Ex area with direct mains power connection. **Never within Ex areas.**

In addition to operation, the battery block in the right-hand slot is also charged here. However, only up to approx. 75 % of the total charging power, which is why NIVUS recommends using the charging tray for charging the battery block (see chapter "23.2.2 Charging the battery block").

WARNING



Risk of explosion when charging the battery pack in Ex areas

The battery pack may **only** be removed/installed and charged **outside** the Ex area. **Never within Ex areas.**

To charge, insert the battery pack to be charged into the right-hand battery slot and connect the plug of the mains adapter/charger (Fig. 23-1) to the multifunction socket of the NivuFlow Mobile. The battery pack can remain in the NivuFlow Mobile during mains operation, which charges it and also serves as a buffer in the event of a mains failure.



Battery slots when charging/discharging

In **charging mode**, only the battery block in the right-hand slot is charged.

In **battery mode** of the rechargeable battery blocks, the battery block with the higher charge level (regardless of the slot) is used until both are at the same voltage level, then both are used simultaneously.

24 Installation of Sensors

This chapter describes the sensors that can be used and their usual locations. The exact description for mounting the sensors is included in the relevant (mounting) instructions.



Note

During assembly work, ensure that all work safety regulations are observed.

24.1 Sensor Installation Principles

The placement of the sensors on the system is decisive for the reliability of the measurement results. Therefore, care must be taken to ensure good hydraulic conditions and a sufficient calming section at the installation site. The sensor types and their mounting must be determined individually, depending on the measuring point.



The conditions for selecting a calming section and mounting the sensors are described in the respective (mounting) instructions.

The measurement place must be parameterised before installation. The corresponding preparation of the measurement place and its dimensions can be taken from the documents of the respective facility.



The parameterisation of the measurement places is described in Chapter "Setting Parameters" starting on page 67.

25 Connection of Sensors

25.1 Cable for Sensor Connection

The sensors are equipped ex works with a permanently connected cable.

25.2 Connecting Sensors

List of connectable flow velocity and level sensors see Chapter "16.2 Connectable Sensors/Devices".

25.2.1 Connection of Sensors directly to NivuFlow Mobile

The sensors are connected to the rear of the NivuFlow Mobile device at the v1, v2/h or Multi I/O sockets. A total of three sensors can be connected directly to the NivuFlow Mobile at the same time, but there is only one connection option for each sensor type. A maximum of one flow velocity sensor CSM/CSP/NPP (Fig. 25-1), one level sensor DSM-L0 (Fig. 25-2) and one level sensor i-Series/NivuBar Plus (Fig. 25-3) can be connected directly.



Fig. 25-1 Connection of CSM, CSP and NPP flow velocity sensors



Fig. 25-2 Connection of DSM-L0 level sensor



Fig. 25-3 Connection of i-Series and NivuBar Plus level sensors

25.2.2 Connecting flow velocity sensors via the adapter box

When using an adapter box (*NFM0 ZAB2 VKK*), **up to three flow velocity sensors** (3-path measurement) and the level sensors mentioned in chapter "25.2.1 Connection of Sensors directly to NivuFlow Mobile" can be connected to the NivuFlow Mobile 750.

In this case, two of the three v-sensors are connected to the adapter box (Fig. 25-4) and the third is connected directly to the NivuFlow Mobile 750 transmitter at socket v1 as shown in Fig. 25-1. An i-Series/NivuBar Plus level sensor is connected to the Multi I/O socket as shown in Fig. 25-3.

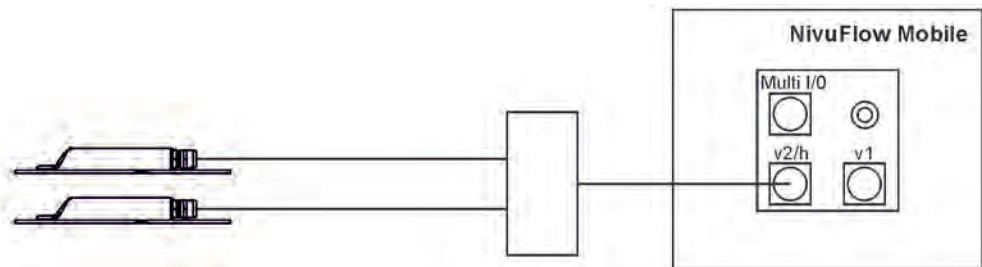

Fig. 25-4 Connecting two flow velocity sensors via the adapter box

25.3 Overvoltage Protection Measures

For effective protection of the NivuFlow Mobile with external power supply, it is necessary to secure the unit by means of overvoltage protection devices.

WARNING



Explosion hazard during operation with direct connection in Ex areas

The unit may **only** be operated **outside** the Ex area with a direct mains connection (e.g. plug-in power supply) or direct external power supply (e.g. solar power supply). **Never within Ex areas.**

When using a **plug-in power supply unit**, NIVUS recommends the types EnerPro 220Tr / 20kA or EnerPro 220Tr / 5kA (Fig. 25-5) for the mains side.

For **direct external power supply** via 12 V DC (e.g. for solar power supply), use the types DataPro 2x1 12V/12V-11mH-Tr(N) for non-Ex areas (Fig. 25-6).

➡ See Chap. "58 Accessories".

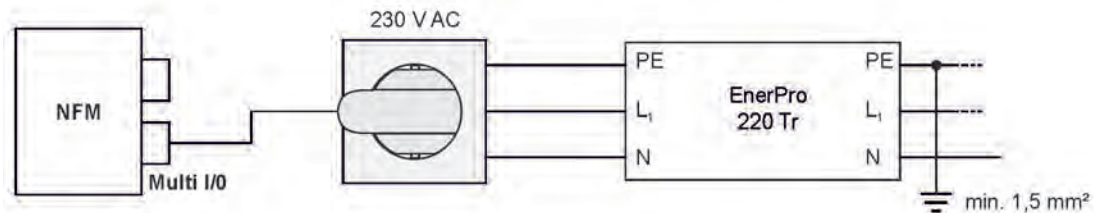

Fig. 25-5 Overvoltage protection for power supply AC general

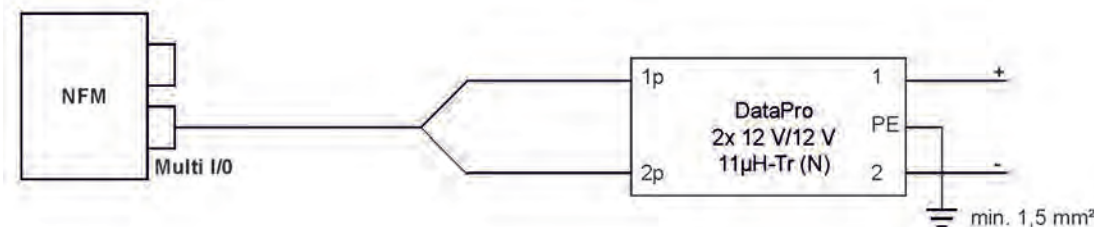

Fig. 25-6 Overvoltage protection for power supply DC general

26 Single external Connection for Inputs/Outputs

If, in addition to the flow velocity/level measurement by the connected sensors, another sensor or actuator is to be connected to the NivuFlow Mobile via the inputs/outputs, this can be done directly with the connection cables for the multifunction socket. Different cables are available depending on the intended use. All are fitted with open cable ends on one side and a plug for the multifunction socket on the other side.

➡ Article numbers see Chap. "58 Accessories".

➡ For more than one external connection see Chap. "27 Connecting the Connector Box for Inputs/Outputs".

27 Connecting the Connector Box for Inputs/Outputs

A Connector Box (Fig. 27-1 Pos. 6) is used if, in addition to the flow velocity/level sensors on the NivuFlow Mobile 750 (Fig. 27-1 Pos. 1), more than one sensor or actuator is to be connected via the inputs/outputs.

➡ For only one external connection see Chap. "26 Single external Connection for Inputs/Outputs".



Connector Box Fastening options

The Connector Box can either be mounted directly on the NivuFlow Mobile in conjunction with the hoop guards (Fig. 27-1 Pos. 2) or attached/stored at another location.

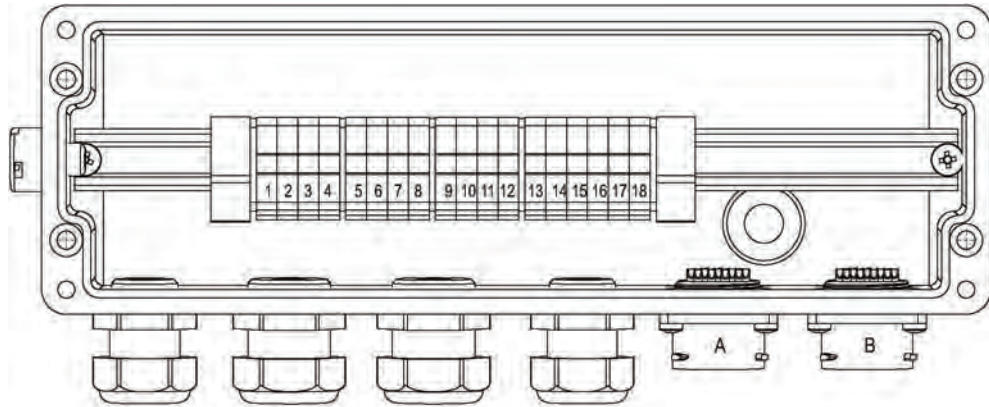

Fig. 27-1 NFM with Connector Box (principle)

➡ Procedure for fastening the Connector Box on the NivuFlow Mobile:

1. Unscrew the rubber buffers (not shown) on the back of the NivuFlow Mobile (Fig. 27-1 Pos. 1).
The two screw-on plates (Fig. 27-1 Pos. 3) (now loose) in the screw-on channels (Fig. 27-1 Pos. 4) and the rubber buffers are needed again in the next step.
2. Attach the hoop guards (Fig. 27-1 Pos. 2) and the screw-on plates to the NivuFlow Mobile with the rubber buffers.
3. Fasten the Connector Box (Fig. 27-1 Pos. 6) to the hoop guards with the screws supplied.
4. Connect the sensors in the Connector Box according to the terminal wiring plan (Fig. 27-2).
5. Insert the plug (Fig. 27-1 Pos. 5) of the Connector Box connection cable into the multifunction socket on the NivuFlow Mobile.

➡ Article numbers see Chap. "58 Accessories".



1	+8,7 V DC
2	No performance
3	No performance
4	RxTx+
5	Shield
6	AI1 -
7	AI1 +
8	AI2 -
9	AI2 +
10	AI3 +
11	AO+
12	GND AI3/AO
13	DI 3,3 V
14	GND
15	12 - 14 V (+)
16	Root contact (COM)
17	Normally closed (NO)
18	Normally open (NC)

A = no performance
B = 12...14 V DC

Fig. 27-2 Terminal wiring Connector Box

Connection B on the Connector Box is used for the external supply of the transmitter NFM (with 12...14 V DC) when the Connector Box is plugged in via the power supply unit/charger (see Chap. "23.2.2 Charging the battery block") or via the 2-wire connection cable (see Chap. "23.2.3 Operation/charging via an alternative voltage source").

28 (T-Shape) Antenna for 2G/3G/4G Remote Data Transmission

For 2G/3G/4G remote data transmission, the supplied T-Shape antenna is required.



Only connect antennas approved for this product

The antenna socket is designed to be intrinsically safe. Only the enclosed antenna or the types NFM0 ANT_x with the longer connection cables may be connected to the NivuFlow Mobile.

Procedure for connection and installation:

1. Plug the antenna cable into the socket on the unit (Fig. 28-1) and tighten the screw connection manually.

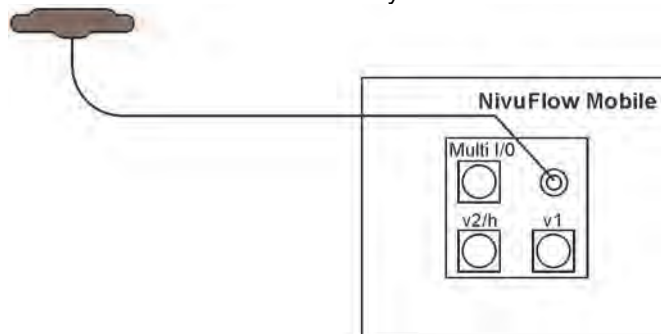

Fig. 28-1 Connecting the 2G/3G/4G antenna

2. Place the antenna at the highest possible position in the shaft or on the dirt trap.
Note:
The T-Shape mobile phone antenna must be positioned to ensure that no person is permanently (longer than 6 minutes) at a distance of less than 25 cm from the antenna.
When the device is operating normally, there is usually no health risk even at smaller distances, as the device only transmits for a short time on the mobile radio interface, but this distance should still be observed as a precautionary measure.
3. If the unit is used in the manhole, close the manhole cover to check whether the data transmission also works when the manhole cover is closed.
4. Use the parameterisation menu Communication to set up a test connection (see Chap. "42 Parameter Menu Communication", >Modem Status< / >Set Up Test Connection<) to check the data transmission. If the connection is poor, change the position of the antenna until data transmission works.

Commissioning

29 Notes to the User

Before connecting and operating the NivuFlow Mobile, the instructions below shall be followed.

This instruction manual contains all information required for parameterisation and use of the transmitter. The instruction manual is intended for qualified expert personnel. Appropriate knowledge in the areas of measurement systems, automation technology, control engineering, information technology and wastewater hydraulics are preconditions for putting the NivuFlow Mobile into operation.

Read this instruction manual carefully to ensure proper functioning of the NivuFlow Mobile. Connect the NivuFlow Mobile according to Chapter "25.2 Connecting Sensors".

If you have any questions regarding installation, connection or parameter setting, please contact our hotline at:

- +49 7262 9191-955

General Principles

Commissioning of the measurement system shall not be carried out before installation has been finished and verified.

Observe the information in this instruction manual to prevent incorrect or faulty or parameterisation. Familiarise yourself with the operation of the transmitter before you start with the parameterisation.

After connecting the transmitter and sensors (according to Chapters "24 Installation of Sensors" and "25 Connection of Sensors") the measurement place must be parameterised.

To do this, in most cases it is sufficient to specify:

- Measurement place geometry and dimensions
- Sensors used and their positioning
- Display units
- Storage mode settings

The user interface of the NivuFlow Mobile is easy to understand. You can quickly make the basic settings yourself.

For faster commissioning, a start assistant is also available. This guides the user in simple steps through the most important points of parameterisation (see Chapter "45 Parameter Menu Quick Start").

30 Lighting System of the Status LED on NivuFlow Mobile

The status LED (Fig. 30-1) on the front of the NivuFlow Mobile lights up during operation according to a predefined system that allows conclusions to be drawn about the current status of the device.

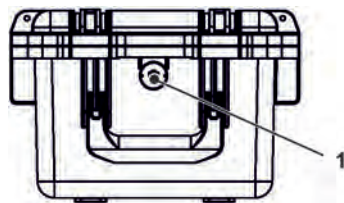

Fig. 30-1 LED on the front of the NFM

If the NFM works without restrictions, the LED lights up **green**: 1x long, pause, 5x short (Tab. 6 No. 1).

If at least one error message is present, the same rhythm applies, but the LED then lights up **red** for a long time (1.5 s), followed by an error code (Tab. 6 No. 9).

Blue light in the pause between the first long light and the five consecutive ones indicates the number of users logged in: 1x for each user (up to max. four logged-in users are possible) (Tab. 6 No. 2...5).

⇒ See also Chap. "36 General Programming".

The LED lights up **white** (Tab. 6 No. 14 Special code: Switch-on sequence without USB stick) when the system is booted, e.g. after plugging in the rechargeable/battery pack or after a firmware update.

Background info:

The colour white is generated by simultaneously illuminating the colours red, green and blue. So white also shows that all colours of the LED are working correctly.

⇒ See also Chap. "41.5.6 Update NivuFlow Mobile 750".

Depending on the status of the transmitter, the colours **yellow**, **magenta/pink** and **cyan/turquoise** are also possible. Details see Tab. 6 No. 6, 10 and 11.

Explanation of the following table of possible light combinations:

- LED oval means 1.5 s active (on or off)
- LED round means 0.5 s active (on or off)
- Each message consists of a start identifier (LED 1.5 s off / 1.5 s on) and a sequence of five short flashing codes (LED 0.5 s on / 0.5 s off) containing the actual information.
- The special codes (Tab. 6 No. 12, 13 and 14) consist of a start identifier (LED red 0.5 s / green 1.5 s) and a sequence of long phases (LED 1.5 s on or off).

Possible light combinations of the status LED

1	OK: Normal operation; no WLAN or modem connections (0 users)	
2	OK: 1 WLAN or modem connection (1 user; blue)	
3	OK: 2 WLAN or modem connections (2 users; blue)	
4	OK: 3 WLAN or modem connections (3 users; blue)	
5	OK: 4 WLAN or modem connections (4 users; blue)	
6	Error: Automatic sensor detection	
7	Error: Battery	
8	Error: HART	

9	Error: Other, undefined error	
10	Warning: Data backup (export) to USB stick is running	
11	Warning: Firmware update (bootloader ext. FLASH) is running	
12	Special code: Start bootloader without USB stick	
13	Special code: Firmware update (bootloader int. FLASH) is running	
14	Special code: Switch-on sequence without USB stick	

Tab. 6 Lighting system of the status LED

31 Connection Setup

31.1 Common

The entire operation of the NivuFlow Mobile is done via a commercially available smartphone/tablet or via a notebook/PC. The operation of the display and operating module used is carried out in accordance with the manufacturer's instructions for the respective unit. The procedure for establishing a connection for the Android, iOS and Windows operating systems is described below.

31.2 Android Operating System

➡ Preparations on NivuFlow Mobile:

1. Ensure power supply: at least one charged rechargeable battery block in the unit or alternatively via the multifunction socket (see Chapter "23.2.3 Operation/charging via an alternative voltage source").
If the rechargeable battery block is now plugged in or the voltage is newly added and the connection setup is continued within the following approx. five minutes, the following work step with the "Wake-Up" can be skipped.
2. "Wake up" NivuFlow Mobile: to do this, hold the supplied magnet (Fig. 31-1 Pos. 2) in front of the Reed contact (Fig. 31-1 Pos. 1; at the front of the NFM) until the LED lights up.

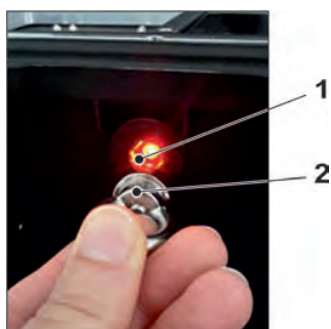

Fig. 31-1 Waking up the NivuFlow Mobile

➡ Work steps on the display and operating module (smartphone, tablet, notebook, PC, etc.):

1. Start the display and operating module.
2. Open the corresponding menu using the Settings symbol (Fig. 31-2 Pos. 1).

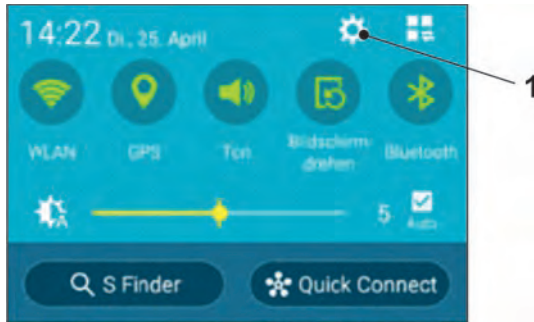

Fig. 31-2 Settings symbol

3. Select WLAN (Fig. 31-3 Pos. 1).

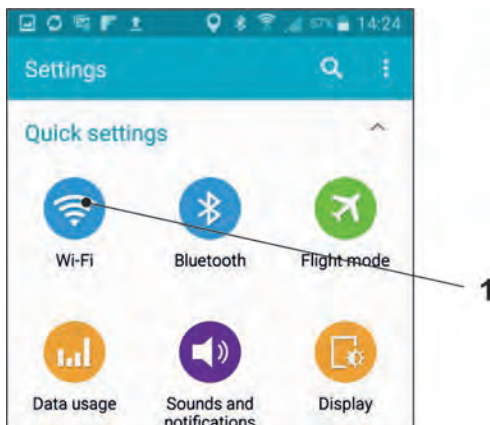

Fig. 31-3 WLAN symbol

4. In the WLAN list select the NFM (Fig. 31-4 Pos. 1) with the corresponding SSID (delivery status = serial number).

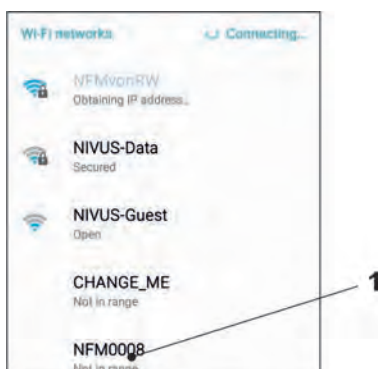

Fig. 31-4 WLAN list

5. Enter the password for server access (delivery status = PUK) (Fig. 31-5 Pos. 1) and connect (Fig. 31-5 Pos. 2).

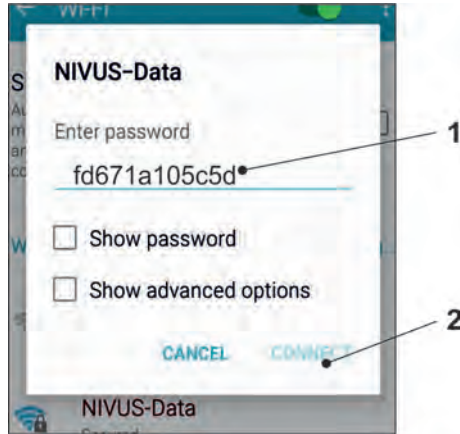

Fig. 31-5 Enter password (here fd671a105c5d as example) and connect

6. Start Internet browser.
7. Enter the IP address "192.168.1.1" in the address field and open.
After successful connection the display of the NivuFlow Mobile (Fig. 31-6) is shown.

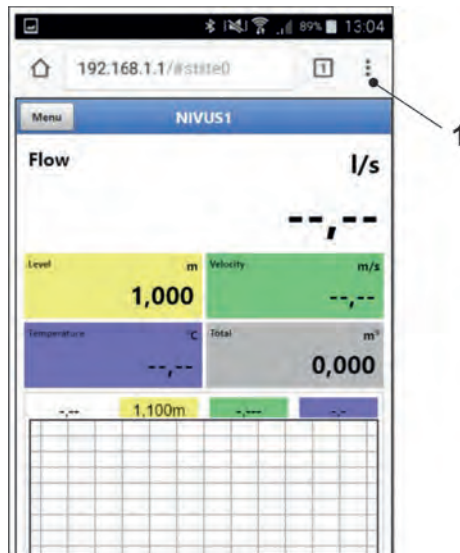

Fig. 31-6 Indication of NFM display in the browser

8. To set up a link on the "Home screen" (for direct access), tap the icon for more tabs (Fig. 31-6 Pos. 1) and settings and select "Add to start screen" (Fig. 31-7 Pos. 1).

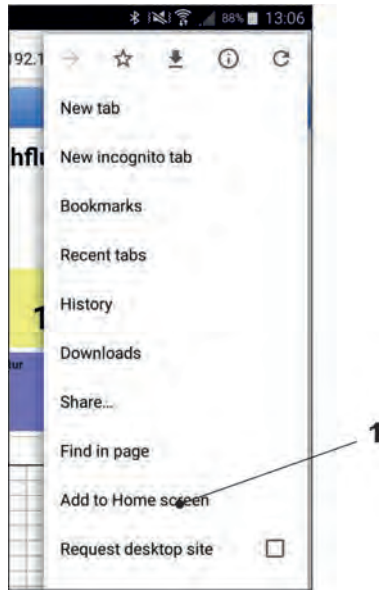

Fig. 31-7 Add to start screen

9. Confirm with "Add" (Fig. 31-8 Pos. 1).

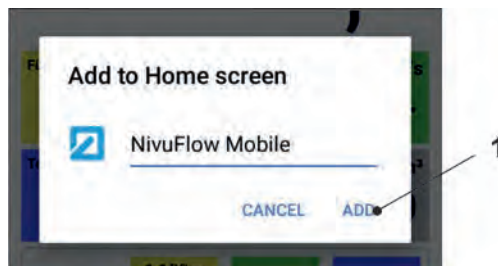

Fig. 31-8 Confirm adding

The shortcut (Fig. 31-9 Pos. 1) appears on the start screen and can be used for immediate entry without entering the IP address.

This link can also be used with any other NivuFlow Mobile transmitter after the respective selection in the WLAN list.

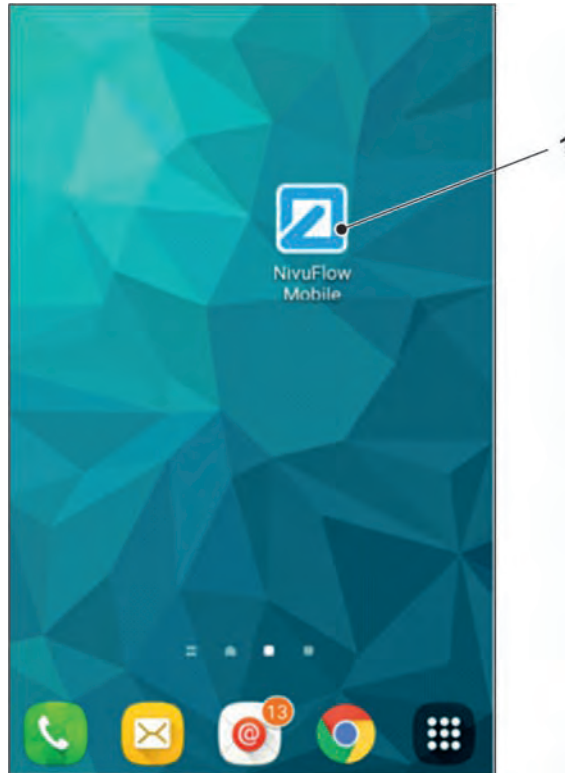

Fig. 31-9 Link on the start screen

31.3 iOS Operating System

➤ Preparations on NivuFlow Mobile:

1. Ensure power supply: at least one charged rechargeable battery block in the unit or alternatively via the multifunction socket (see Chapter "23.2.3 Operation/charging via an alternative voltage source").
If the rechargeable battery block is now plugged in or the voltage is newly added and the connection setup is continued within the following approx. five minutes, the following work step with the "Wake-Up" can be skipped.
2. "Wake up" NivuFlow Mobile: to do this, hold the supplied magnet (Fig. 31-10 Pos. 2) in front of the Reed contact (Fig. 31-10 Pos. 1; at the front of the NFM) until the LED lights up.

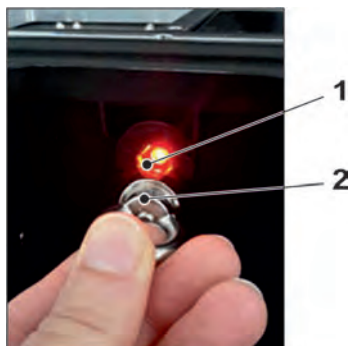

Fig. 31-10 Waking up the NivuFlow Mobile

➤ Work steps on the display and operating module (smartphone, tablet, notebook, PC, etc.):

1. Start the display and operating module.
2. Open the corresponding menu using the Settings symbol (Fig. 31-11 Pos. 1).



Fig. 31-11 Settings symbol

3. Select WLAN (Fig. 31-12 Pos. 1).



Fig. 31-12 WLAN symbol

4. In the WLAN list select the NFM (Fig. 31-13 Pos. 1) with the corresponding SSID (delivery status = serial number).



Fig. 31-13 WLAN list

5. Enter the password for server access (delivery status = PUK) (Fig. 31-14 Pos. 2) and connect (Fig. 31-14 Pos. 1).



Fig. 31-14 Enter password and connect

6. Start Internet browser.
7. Enter the IP address "192.168.1.1" in the address field and open.
After successful connection the display of the NivuFlow Mobile (Fig. 31-15) is shown.

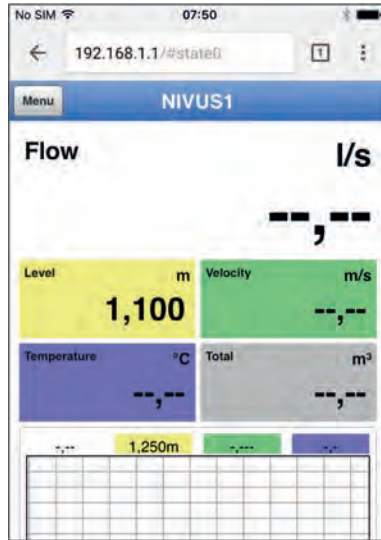

Fig. 31-15 Indication of NFM display in the browser

8. To set up a link on the Home screen (for direct access), tap the "Provide" icon (Fig. 31-16 Pos. 1).

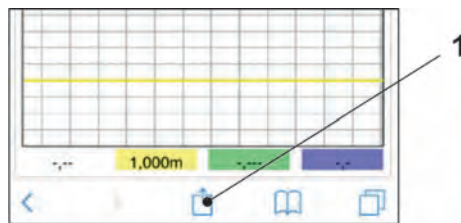

Fig. 31-16 Set up link

9. Select "To Home screen" (Fig. 31-17 Pos. 1).

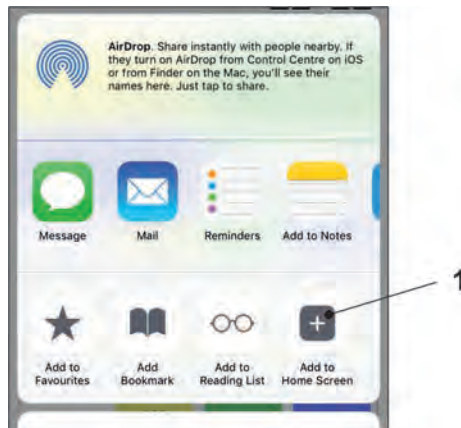

Fig. 31-17 To Home screen

10. Confirm with "Return" (Fig. 31-18 Pos. 1).

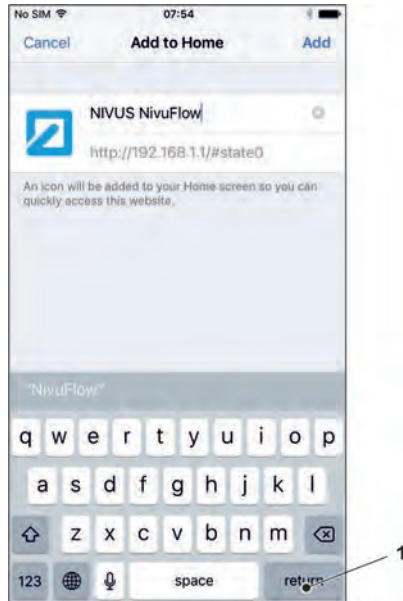

Fig. 31-18 Confirm adding

The shortcut (Fig. 31-19 Pos. 1) appears on the start screen and can be used for immediate entry without entering the IP address.

This link can also be used with any other NivuFlow Mobile unit after the respective selection in the WLAN list.



Fig. 31-19 Link on the start screen

31.4 Windows Operating System

🔄 Preparations on NivuFlow Mobile:

1. Ensure power supply: at least one charged rechargeable battery block in the unit or alternatively via the multifunction socket (see Chapter "23.2.3 Operation/charging via an alternative voltage source").
If the rechargeable battery block is now plugged in or the voltage is newly added and the connection setup is continued within the following approx. five minutes, the following work step with the "Wake-Up" can be skipped.
2. "Wake up" NivuFlow Mobile: to do this, hold the supplied magnet (Fig. 31-20 Pos. 2) in front of the Reed contact (Fig. 31-20 Pos. 1; at the front of the NFM) until the LED lights up.

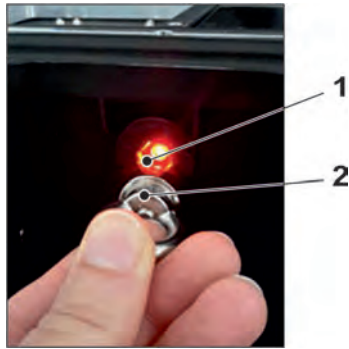

Fig. 31-20 Waking up the NivuFlow Mobile

- ➡ Work steps on the display and operating module (smartphone, tablet, notebook, PC, etc.):
1. Start the display and operating module.
 2. Go to the overview of the available (WLAN) networks (Fig. 31-21 Pos. 2).
 3. In the WLAN list select the NFM (Fig. 31-21 Pos. 1) with the corresponding SSID (delivery status = serial number).



Fig. 31-21 (WLAN) Network list

4. Enter security key (password) (delivery status = PUK; here fd671a105c5d as example) (Fig. 31-22 Pos. 1) and connect.

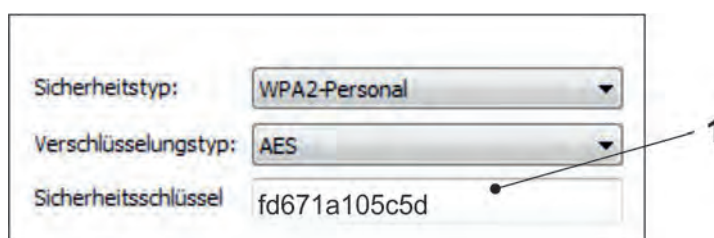

Fig. 31-22 Enter security key and connect

5. Start Internet browser.

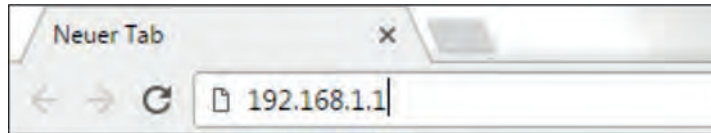

Fig. 31-23 Address field

- Enter the IP address "192.168.1.1" in the address field (Fig. 31-23) and open. After successful connection the display of the NivuFlow Mobile (Fig. 31-24) is shown.

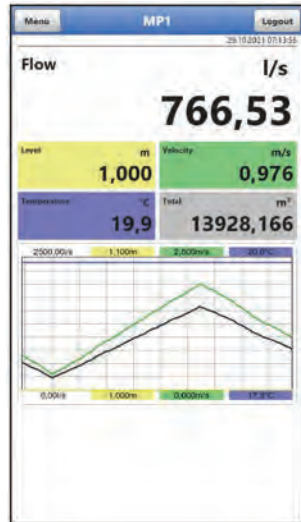

Fig. 31-24 Indication of NFM display in the browser

- To set up a favourite in the browser (for direct access), tap the star for "Favourites" (Fig. 31-25 Pos. 1) (Google Chrome is used as an example) and confirm with "Done" (Fig. 31-25 Pos. 2).



Fig. 31-25 Setting up favourite

The bookmark appears on the bookmark bar (Fig. 31-26 Pos. 1) and can be used for immediate access by simply selecting it without entering the IP address.

This link can also be used with any other NivuFlow Mobile unit after the respective selection in the WLAN list.

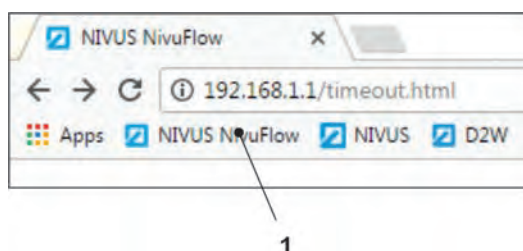
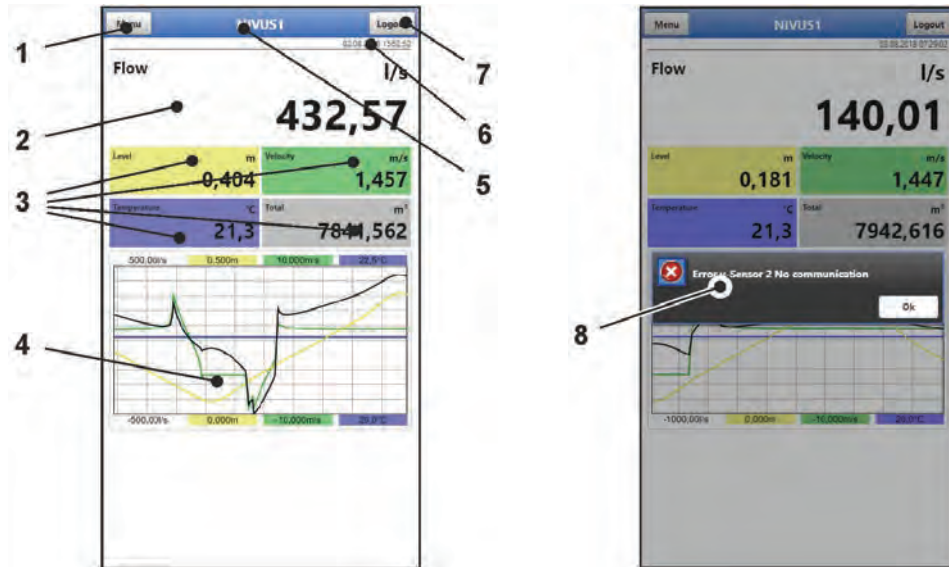

Fig. 31-26 Link in the bookmarks bar

32 Menu Control/Overview

32.1 Overview Display

Via the NIVUS display you can see at any time where you are in the menu and which entries you are currently editing.



- 1 Menu / Back (depending on the display view)
- 2 Display Area 1 (output field 1 for the flow measurement)
- 3 Display Area 2 (output field 2...5 for level, average velocity, medium temperature and totaliser)
- 4 Display Area 3 (trend graph on level, velocity, medium temperature and flow rate)
- 5 Measurement place name or designation of the opened menu and service symbol, if applicable
- 6 Date and Time
- 7 Logout (disconnecting the operating and display module from the transmitter; the transmitter continues to run with the last saved settings)
- 8 Possible error message, information or display for active service mode (one-time display, directly after opening as a separate window in the centre of the display; close with "Ok")

Fig. 32-1 Display view

If the symbol of a hand with a spanner is shown in the upper area of the display next to the measurement place name or next to the designation of the opened menu (Fig. 32-2), the transmitter is in service mode.

Usually the service mode is only selected when the NIVUS support (consultation with service/hotline) has direct or remote access to the transmitter.

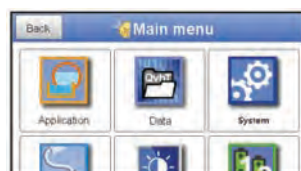

Fig. 32-2 Service symbol

The transmitter remains in service mode until the session ends.

The session can be ended by:

- Closing the browser
- Selecting "Logout" in the top right display corner
- Setting the transmitter to powerdown mode (via >System< / >Service< / >Powerdown<)
- The automatic idle state of the transmitter due to longer inactivity (no more action by the user)

Alternatively, the service mode can also be closed directly by selecting the field "Service Level" and

- entering an incorrect password (any letter / any number) and confirming with "Enter" or
- without entering a password and confirming the empty field with "Enter".

32.2 Save Parameters

After changing parameters and scrolling back via the menu field, the changed parameters must be saved before the changes take effect. After saving, the status message "Successful" appears (Fig. 32-2).



Fig. 32-3 Save parameters

- ➡ Procedure for saving see Chapter "36.1 Save Parameters".

32.3 Menus

All menus are described in a logical programming sequence in chapter "Setting Parameters" starting on page 67.

There are eight basic menus available in the main menu. These become visible and selectable by selecting the "Menu" field (from the main display) or the "Back" field (from within the submenus).

In detail these are:

Application	Guides commissioning personnel through the complete parameterisation of measurement place dimensions, sensor selection, analogue and digital inputs/outputs and diagnostics
Data	<ul style="list-style-type: none"> - Graphical representation of the progression of flow rate, level and (average) flow velocity - Tabular display of 24-hour daily totals - Saving of data - Saving and loading of parameters
System	<ul style="list-style-type: none"> - Retrieval of basic information (serial number, version, item number, etc.) on the transmitter (required for queries with NIVUS GmbH) - Setting the language and date format under >Country Settings< - Setting the system time and time zones under >Time/Date< - Error messages under >Error Messages< - Service Levels - Configure Storage Cycle - Parameter/System Reset - Feature Unlock - Shut Down Device (Powerdown) - Information about the rechargeable battery blocks and the current capacity
Communication	Setting parameters for the communication interfaces of the NivuFlow Mobile
Indication	Setting the output fields (text, decimal places etc.)
Battery (12V)	Selection/number of the battery(ies) of the rechargeable battery block(s) used
Quick Start	Guided, quick parameterisation of simple measuring points
Alarm	Activate the alarm for sensor errors and set the upper and lower limits/thresholds at which an alarm is sent by e-mail via the NIVUS WebPortal.

Tab. 7 Menu overview

Main Screen

33 Functions of the Main Screen

Quick Access

In addition to displaying the values themselves, the main screen also allows for direct access to the most important setting parameters.

The quick access enables to directly jump to important individual menus without having to go through the (sub)menus of the parameterisation. It hence serves as quick and uncomplicated check of the individual sensors involved in the measurement.

Quick diagnosis, uncomplicated parameter adjustment and adjustment are possible by using the quick access. Direct queries for basic device data such as serial and article numbers as well as the firmware version of the transmitter and the connected sensors are also possible in just a few steps.

34 General Overview

The following information is provided in the **top area** of the display:

- Menu and Logout Icons
- Measurement place name and service symbol, if applicable
- Date and Time

In operation mode the NivuFlow Mobile 750 displays the following important measured values in the **main area**:

- Flow
- Level
- Velocity
- Temperature
- Total

The **lower part** of the display shows a chart for flow, level, velocity, temperature and total.

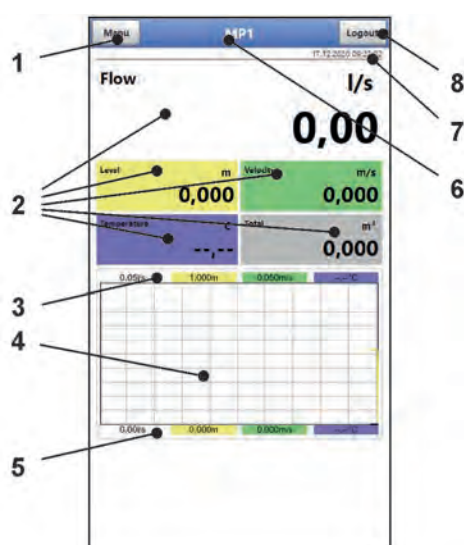

- 1 Icon to open the main menu
- 2 Output fields for the values flow, level, velocity, temperature and total
- 3 Upper scaling range for the diagram
- 4 Charts indicating flow, level, velocity, temperature and total

- 5 Lower scaling range for the diagram
- 6 Measurement place name and service symbol, if applicable
- 7 Date and Time
- 8 Icon for logging out the operating and display module

Fig. 34-1 Main screen overview (example without measurement values)

A pop-up menu with the most important settings and information can be accessed directly via the fields of the main display with a mouse click (left button). A further mouse click on the selection opens the respective pages and offers the possibility to parameterise or view current states.

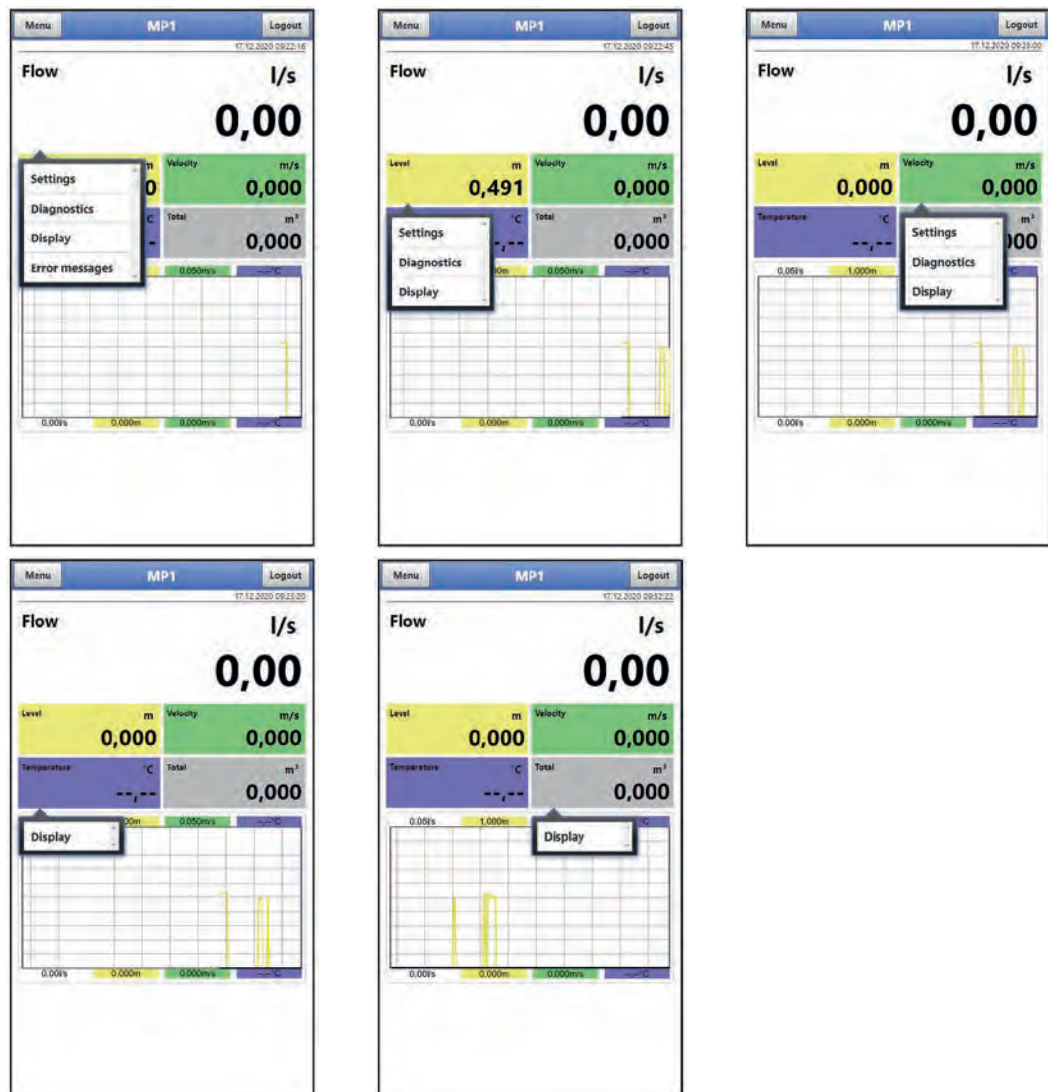

Fig. 34-2 Pop-up menus



Save Parameters

After changing system-specific parameters, the changes must be saved for them to take effect.

35 Display Fields

35.1 Display Field Flow

When clicking on the pop-up menus, the transmitter opens the following pages:

- Settings: >Application< / >Measurement Place<; see Chapter "39.1 Menu Measurement Place"
- Diagnostics: >Application< / >Diagnostics<; see Chapter "47 Basics of the Diagnostics Menu"
- Display: >Display<; see Chapter "43 Parameter Menu Display"
- Error Messages: >System< / >Error Messages< / >Active Error Messages<; see Chapter "41.4 Menu Error Messages"

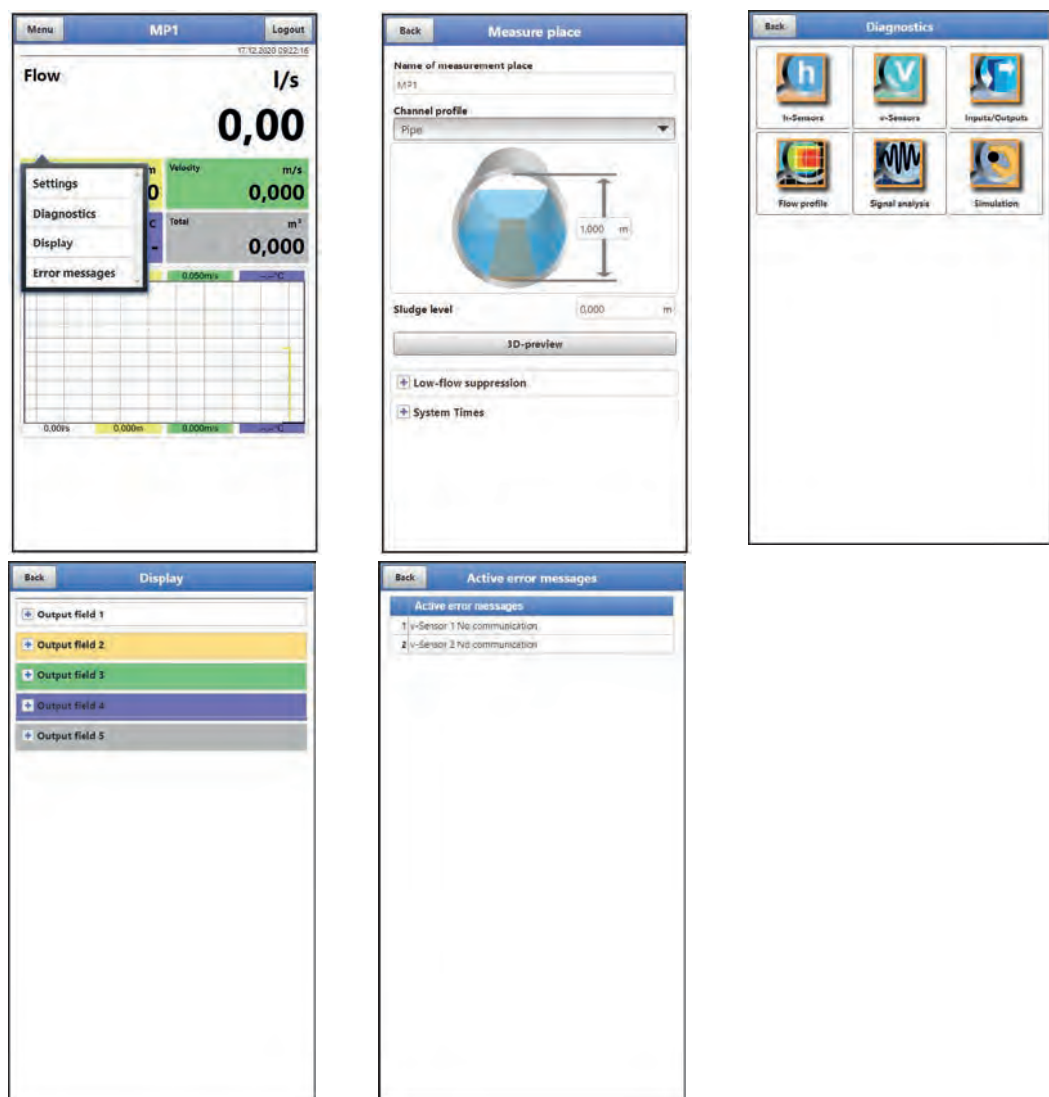

Fig. 35-1 Opened display fields with flow

35.2 Display field level

When clicking on the pop-up menu, the transmitter opens the following pages:

- Settings: >Application< / >h-Sensors<; see Chapter "39.2 Menu h-Sensors"
- Diagnostics: >Application< / >Diagnostics< / >h-Sensors<; see Chapter "48 Menu Diagnostics h-Sensors"
- Display: >Display<; see Chapter "43 Parameter Menu Display"

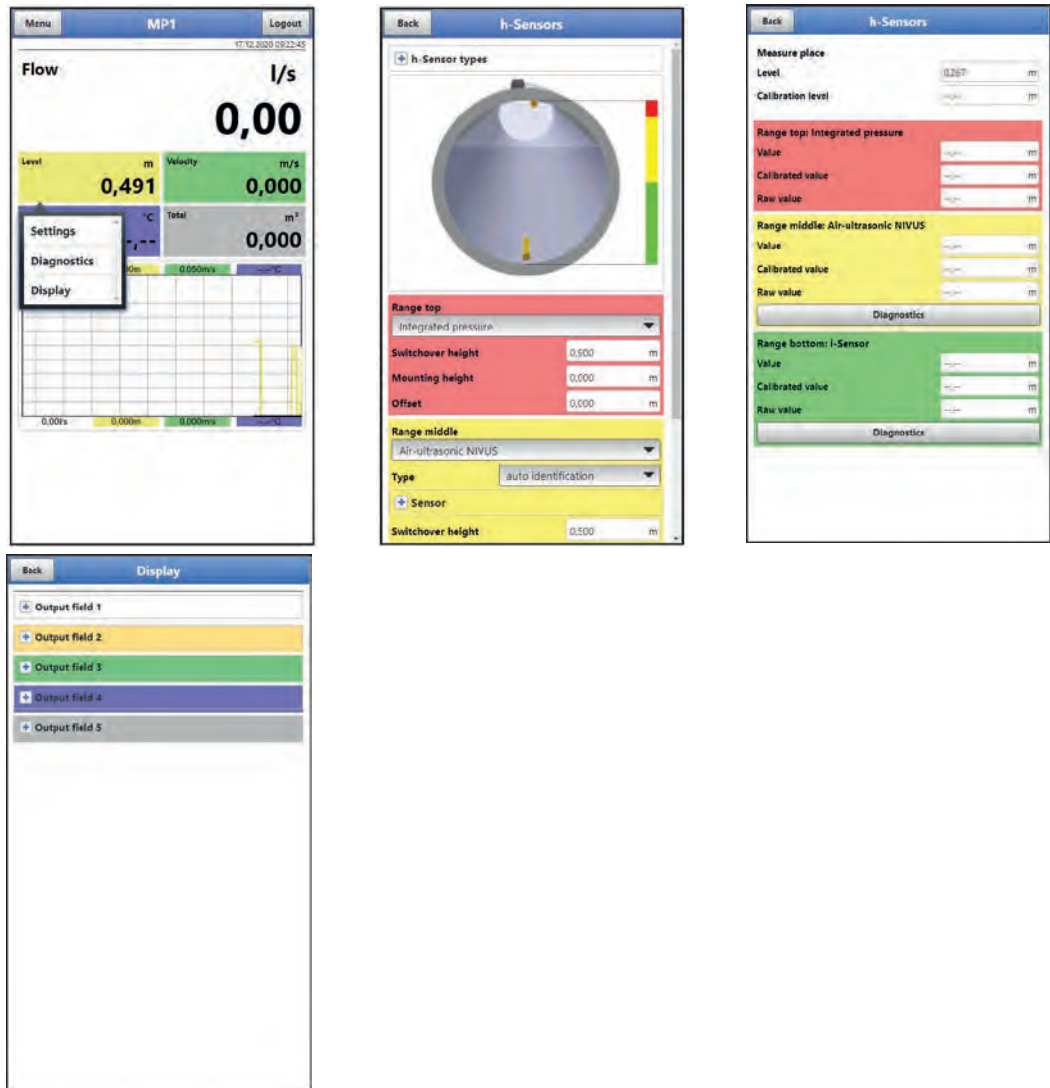

Fig. 35-2 Opened display fields with level

35.3 Display Field Velocity

When clicking on the pop-up menu, the transmitter opens the following pages:

- Settings: >Application< / >v-Sensors<;
see Chapter "39.3 Menu v-Sensors"
- Diagnostics: >Application< / >Diagnostics< / >v-Sensors<;
see Chapter "49 Menu Diagnostics v-Sensors"
- Display: >Display<;
see Chapter "43 Parameter Menu Display"

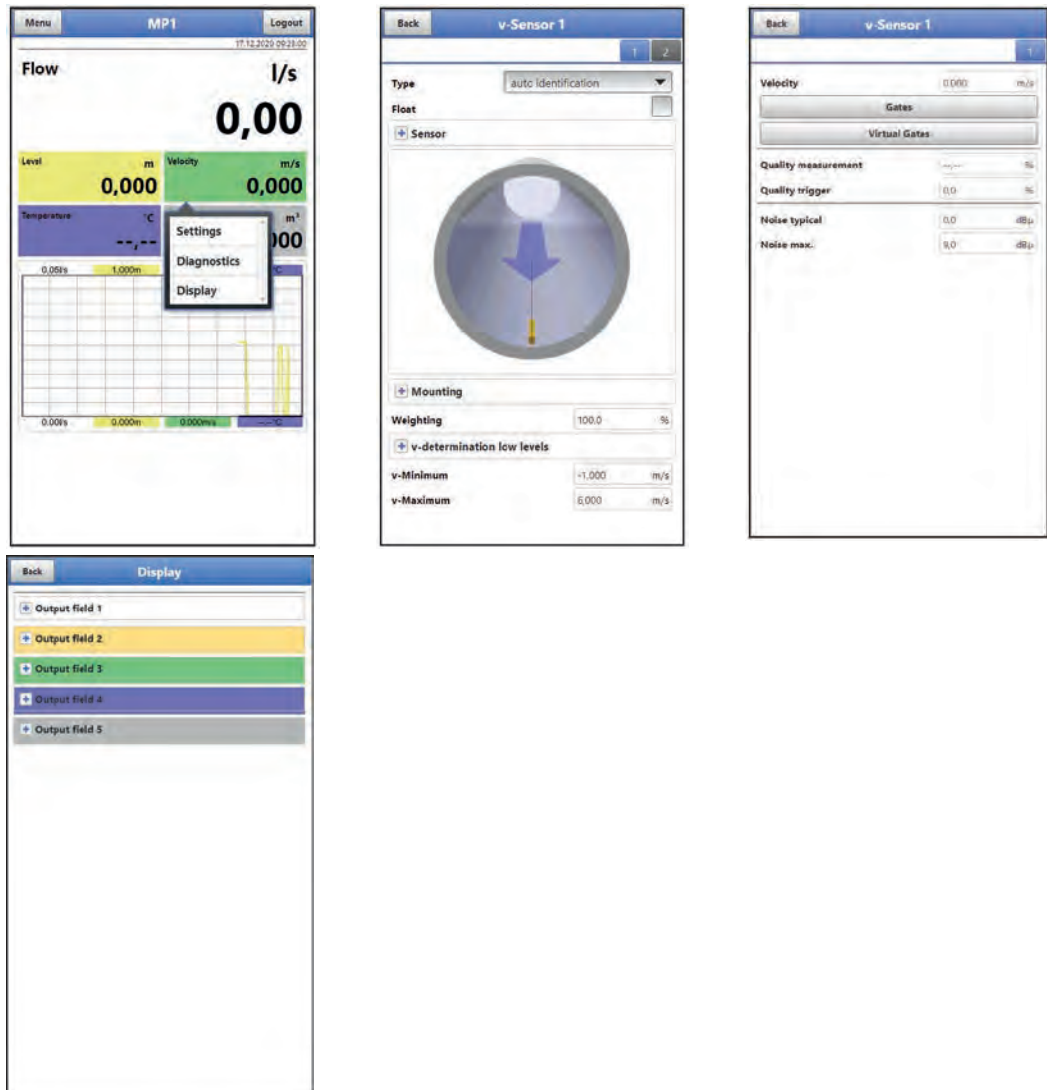

Fig. 35-3 Opened display fields with velocity

35.4 Display field Temperature

When clicking on the pop-up menu, the transmitter opens the following page:

- Display: >Display<;
see Chapter "43 Parameter Menu Display"

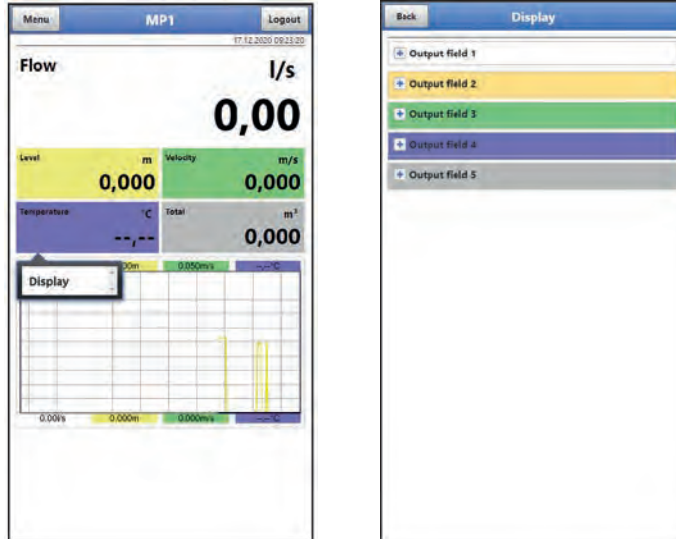

Fig. 35-4 Opened display fields with signal temperature

35.5 Display Field Total

When clicking on the pop-up menu, the transmitter opens the following page:

- Display: >Display<;
see Chapter "43 Parameter Menu Display"

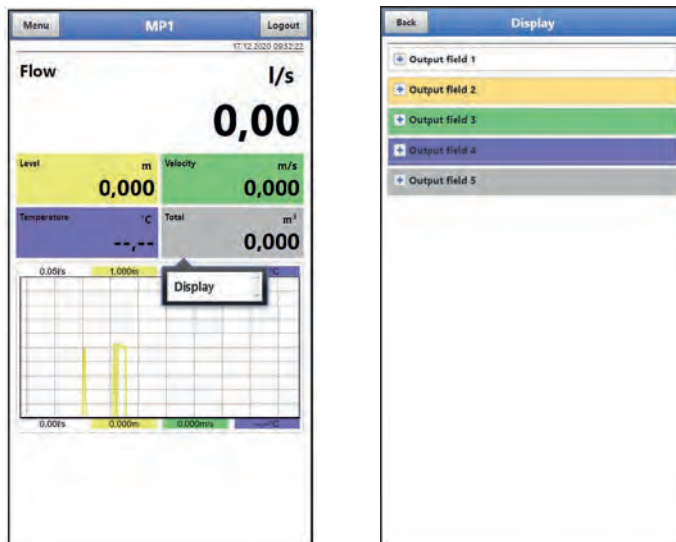

Fig. 35-5 Opened display fields with total

Setting Parameters

36 General Programming

In principle, changed parameters do not become effective before they have been saved. When exiting all menus via the "Back" field, the transmitter checks whether parameters have been changed. Finally, you are asked whether the parameters should be saved.

- >Yes<: the changed parameter setting is accepted and saved.
- >No<: the changes to the parameters are discarded and the device exits the menus.
- >Cancel<: You exit the query. The parameters remain changed, but are not yet effective and not saved.



Tip for repeated measurement of the same measurement places

If measuring points are not only measured once but repeatedly, it is recommended to save the parameterisation of the measuring point and, if necessary, also the measurement data on a USB stick. During the next measurement at the measuring point in question, these can then be quickly reloaded onto the transmitter and there is no need for new parameterisation.

See Chapter "40.3 Menu Data Memory" starting on page 114.

36.1 Save Parameters

After entering all necessary (measurement place) parameters, these must be saved to become effective.

➡ Procedure:

1. Select "Back" 3 times: a window opens with the message >Save Parameters?<. Confirm with >Yes< *. The message "Successful!" indicates the completed saving of the parameters.

* >Yes< saves the new parameters; >No< cancels the saving process and the last saved parameters are active again; >Cancel< cancels the saving process, the last changed parameters remain active and the initialisation process can be continued.

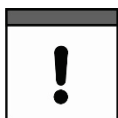

Multiple users can access simultaneously

Up to four users can access the transmitter and its parameterisation simultaneously via the WLAN access. Simultaneous access is only indicated via the status LED.

If changes in the parameterisation are necessary, make sure that this is done in consultation and that there is no simultaneous access. The last saved parameter is always valid.

36.2 Change WLAN Password

The WLAN password is set **per default** to an individually determined identifier for the device. This is attached as a sticker on the top of the transmitter (inside the enclosure).

This factory-assigned password can be changed as described below. The new password must have between 8 and 32 characters.

➡ Procedure:

1. Open the main menu via "Menu".
2. Open the >Communication< menu.

3. Open the >WLAN< menu.
4. Select the >Password< field.
5. Enter the new password and confirm.

Up to four users can access the transmitter and its parameterisation simultaneously via the WLAN access. Simultaneous access is not indicated or logged.

If changes in the parameterisation are necessary, make sure that this is done in consultation and that there is no simultaneous access. The last saved parameter is always valid.



Keep your password safe

Only give the password to authorised persons.

If you write down the password, keep it in a safe place.

36.3 Change the device SSID

The SSID is set **per default** to the serial number of the unit. This is written on the nameplate on the side of the enclosure.

This factory-assigned SSID can be changed as described below. The new SSID must have between 8 and 32 characters.

➡ Procedure:

1. Open the main menu via "Menu".
2. Open the >Communication< menu.
3. Open the >WLAN< menu.
4. Select the >SSID< field.
5. Enter the new name and confirm.

36.4 Loss of the Password

Each NivuFlow Mobile is delivered with a PUK ("Personal Unblocking Key" or also Super PIN). This allows the unit to be reactivated if the password is forgotten and a new password can be assigned.

This PUK is identical to the default WLAN password which is attached as a sticker on the top of the transmitter (inside the enclosure).

➡ Procedure:

1. Open the cover.
2. Loosen the hexagon socket screws on the cover above the battery compartment and remove the cover.
3. Take out the rechargeable battery blocks.
4. Hold the magnet against the Reed contact and at the same time insert a rechargeable battery block.
The magnet must be held against the Reed contact for at least 15 seconds until the LED flashes red several times. The NivuFlow Mobile will be "woken up".
5. The NFM appears in the WLAN list with the default SSID (identical to the serial number of the respective device according to the nameplate).
6. Enter the default PUK as password.
7. Enter new password and possibly also the SSID according to Chapters "36.2 Change WLAN Password" and "36.3 Change the device SSID".
8. To adopt the new password/SSID, reinitialise the unit by removing and re-inserting the rechargeable battery blocks.

9. Activate the NFM within five minutes, otherwise the password changes will not be accepted and the unit will continue to report under the default identifier and will only respond to the factory-assigned password.
10. If necessary, insert a second rechargeable battery block.
11. Replace the cover over the battery compartment with the hexagon socket screws and close the cover.

36.5 Automatic Data Transmission to USB Stick

Normally, data stored on the NivuFlow Mobile is transmitted to the display and control module via WLAN.

➡ See Chapter "40.3 Menu Data Memory".

If, in exceptional cases, this is not possible because, for example, a WLAN connection cannot be established, the display and operating module is not functioning correctly or its battery is empty, it is possible to automatically read out the data memory with the measurement data via an inserted USB stick.



Use of the USB interface is only permitted outside the Ex area.

🔄 Procedure:

1. Open the enclosure.
2. Insert the USB stick.
3. "Wake up" the NivuFlow Mobile by using the magnet.
If no WLAN connection is established within 5 minutes, the transmitter automatically transfers the complete contents of the measurement data memory to the inserted USB stick. The status LED on the transmitter flashes green during this time.
4. After the status LED has stopped flashing, the data transfer is complete and the USB stick can be removed.

37 Procedure for Setting Parameters via Quick Start

This menu enables quick parameterisation of simple measurement places using the factory settings for various parameters.

➡ The >Quick Start< menu is described in detail in the Chapters "38.2.7 Menu - Quick Start" and "45 Parameter Menu Quick Start".

🔄 Procedure:

1. Open the main menu.
2. Select the menu >Quick Start<.
The query "Create new Measurement Place?" is made.



Fig. 37-1 Quick start with query

3. Either select >No<: the >Country Settings< page of the >Quick Start< menu opens. Or select >Yes<: the security question "Sure? Old parameters and archive data are deleted!" is asked.
If confirmed here with >Yes<, the transmitter deletes the old parameters, scans the application for completely connected sensors and indicates the completion with the message "Successful!" as well as a list of detected sensors.
However, if you confirm with >No<, nothing is deleted and the >Country Settings< page opens.



Previously connected sensors facilitate parameterisation

If the transmitter detects previously connected sensors during the sensor scan, the pages for the h/v sensors are already automatically parameterised/pre-set.

Detailed individual parameterisation is then no longer necessary.

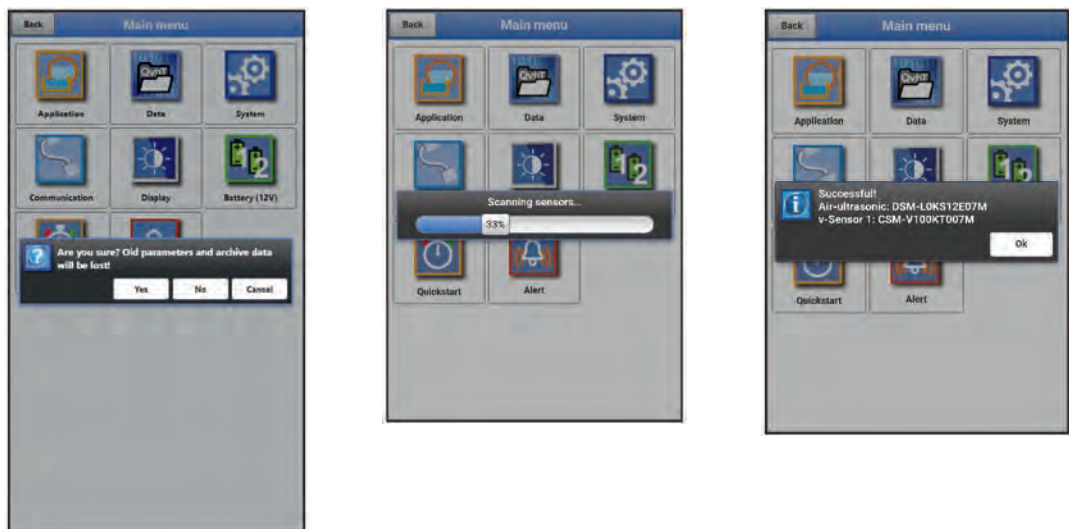

Fig. 37-2 Security query "Deleting Parameters and Data"

4. On the >Country Settings< page, set the language, the date format, the different units, the system time and the memory mode (operating mode and storage cycle).



Fig. 37-3 Menu >Country Settings<

5. Continue with the arrow keys to go the next page >Measurement Place<.
6. Ste the measurement place parameters: Define measurement place name and channel profile including dimensions.

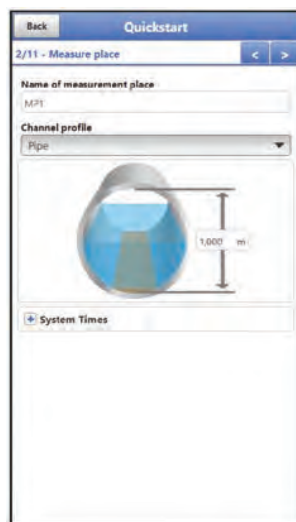

Fig. 37-4 Menu >Measurement Place<

7. Continue with the arrow keys to go the next page >h-Sensors<.
8. On the >h-Sensors< page, select the level sensors and parameterise them accordingly or briefly check the detected sensor data.



Fig. 37-5 Menu >h-Sensors<

9. Use the arrow keys to go the next page.
Here and on the next two pages, parameterise the v-sensors 1...3:
select the type used or automatic sensor recognition and enter/select all associated data on >Installation<, >Weighting<, >v-Determination of low Levels< or >v-Minimum< and >v-Maximum< or briefly cross-check the recognised sensor data.

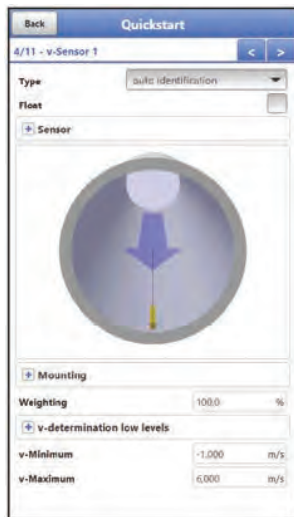

Fig. 37-6 Menu >v-Sensor x<

10. Use the arrow keys to go the next page.
Parameterise the analogue inputs and the digital input here and on the following pages.



Fig. 37-7 Menu >Analogue Input x< / Menu >Digital Input 1<

11. Use the arrow keys to go the next page.
12. Set the communication parameters via GPRS accordingly.
Make sure that the unit automatically searches for the GPS coordinates (latitude/longitude) and that these are then entered in the menu. This may well take a few minutes.



See also Chapter "42 Parameter Menu Communication".



Fig. 37-8 Menu >Communication<

13. Return to the main menu with "Back": The query for saving the parameters is made. If >Yes< is selected, saving is confirmed with the message "Successful!". Press >OK< to open the main menu.
 If >No< is selected, nothing is saved and the main menu is opened.
 With >Cancel< the current page >Communication< remains open and the parameterisation on this page can be continued.
 OR
 Complete the quick start parameterisation by clicking on the small arrow pointing upwards at the top right of the menu:



The prompt for saving the parameters appears.

If >Yes< is selected, saving is confirmed with the message "Successful!". Press >OK< to open the main menu.

If >No< is selected, nothing is saved and the main menu is opened.

With >Cancel< the current page >Communication< remains open and the parameterisation on this page can be continued.

14. Use "Back" (again) to go back to the main screen.

38 Parameter Functions

38.1 Main Menu

The NivuFlow Mobile 750 is parameterised via the total of eight settings menus.

The individual menus are explained in greater detail starting with Chapter "39 Parameter Menu Application". In the main menu there are eight icons with the functions described below:



Fig. 38-1 Overview Main Menu

38.2 Functions of the first Menu Level

38.2.1 Menu - Application

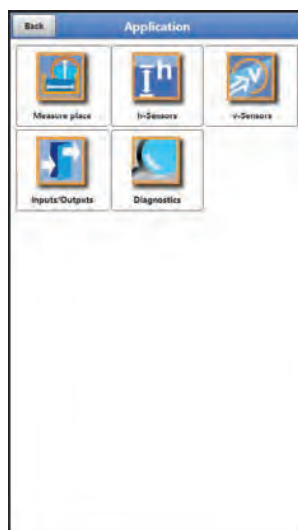

Fig. 38-2 Menu Application

This menu is the most comprehensive and important within the parameterisation of the NivuFlow Mobile. The application menu includes five submenus.

The shape and dimensions of the measurement place are programmed here. The flow velocity and level sensors used are defined and the data for their mounting position is programmed.

Moreover, the required analogue and digital inputs and outputs can be defined here:

- Functions
- Measurement Ranges
- Measurement Spans
- Limit Values

This menu provides diagnostic options for:

- Flow velocity and level sensors
- Inputs and outputs
- Flow profile
- Signal analysis
- Simulation

Possible entries or changes within this menu:

- Constant, fixed sludge levels
- Low-flow suppression
- Damping of signal evaluation/output
- Stability of signal evaluation/output

38.2.2 Menu - Data



Fig. 38-3 Menu Data

The data menu includes all internally saved measurement values.

The following functions are available:

- Graphic representation of the measurement values
- Listing of the last 100 24h day totals
- Communication and transmission options of internal files
- Transfer of set parameters from and to USB stick
- Setting and deleting options of the internal data memory

38.2.3 Menu - System



Fig. 38-4 Menu System

This menu contains information on the transmitter:

- Firmware version
- Article Number
- Serial Number
- Information on battery voltage and credits/licences

In addition, the following settings are possible:

- Language
- Units
- Correction of date and time
- Read active error messages
- Delete error memory
- Configure Storage Cycle
- Shut Down Device (Powerdown)
- Execute parameter reset
- Unlock licenced functions
- Carry out firmware updates

38.2.4 Menu - Communication



Fig. 38-5 Menu Communication

This menu contains the setting options for communication with other systems:

- WLAN
- GPRS

38.2.5 Menu - Display

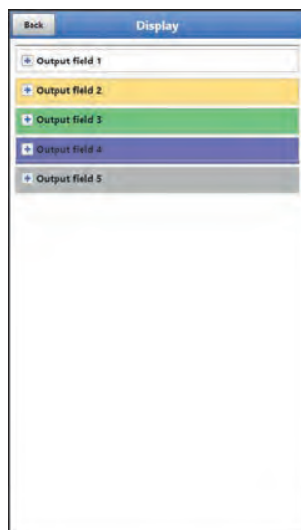

Fig. 38-6 Menu Display

This menu defines the five display fields of the main display.

38.2.6 Menu - Battery



Fig. 38-7 Menu Battery (12V)

In the Battery menu, the battery types used and their number are selected.



Correct display of the capacity indicator

The capacity display in the >System< / >Information< menu only works reliably if fully charged battery blocks are used and the battery type and number of rechargeable battery blocks used are entered here.

At voltages <11.5 V (capacity 20 %), voltage dips and undervoltage shutdown may occur during remote data transmission.

NIVUS recommends replacing the rechargeable battery blocks at the latest when the remaining capacity is 20 %.

Tip:

By using two rechargeable batteries, storing and using them at non-critical temperatures (such as room temperature) and storing them dust-free, clean and dry, their capacity can be maintained for longer.

This means that even remote data transmission can often still function well at values below the threshold of 20 %.

38.2.7 Menu - Quick Start



Fig. 38-8 Menu Quick Start

This menu enables quick parameterisation of simple measurement places using the factory settings for various parameters.

Depending on the number of v-sensors connected, there are up to ten pages in the >Quick Start< menu:

- Page 1 >Country Settings<
- Page 2 >Measurement Place<
- Page 3 >h-Sensors<
- Page 4 >v-Sensor 1<
- Page 5 >v-Sensor 2<
- Page 6 >v-Sensor 3<
- Page 7 >Analogue Input 1<
- Page 8 >Analogue Input 2<
- Page 9 >Analogue Input 3<
- Page 10 >Digital Input 1<
- Page 11 >Communication<

38.2.8 Menu - Alarm

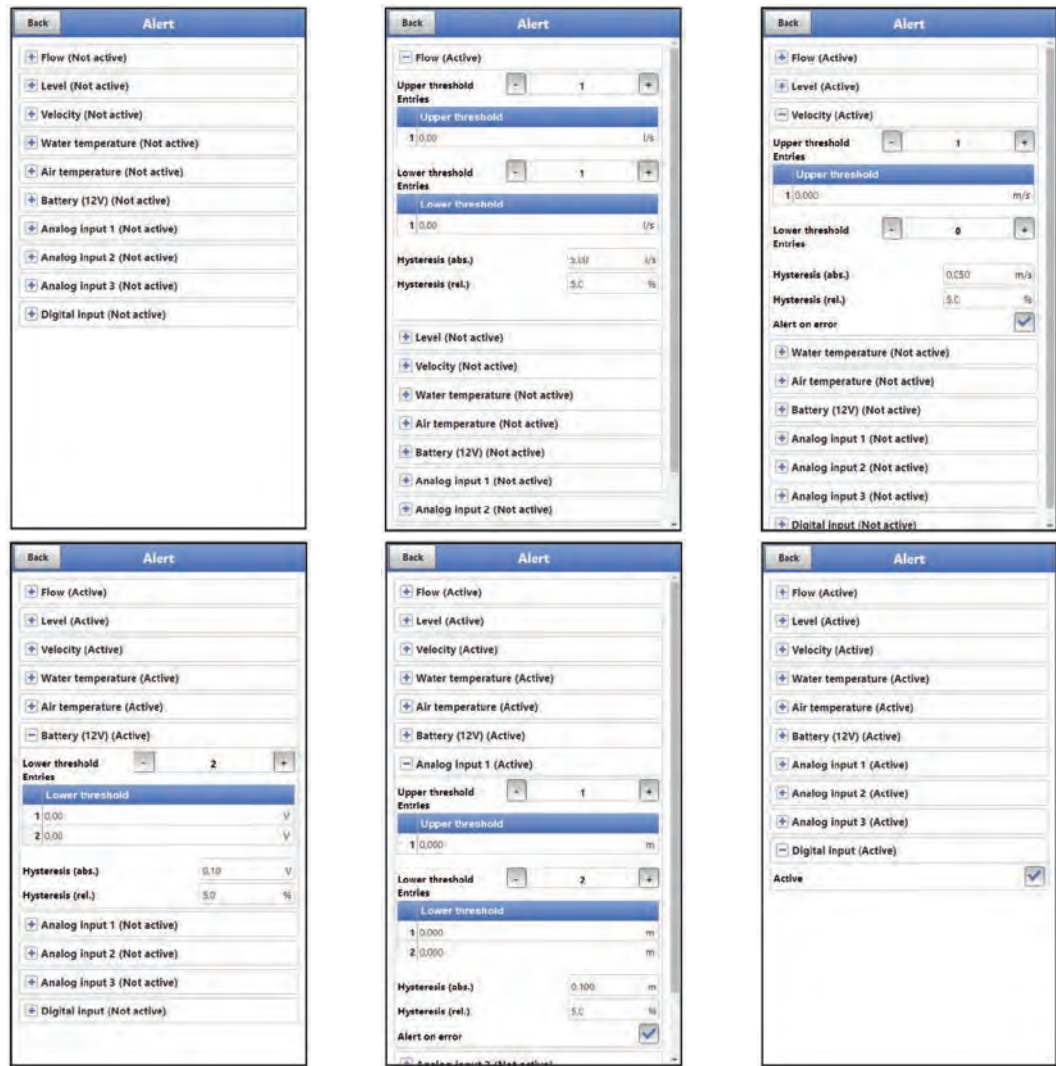

Fig. 38-9 Menu Alarm

The Alarm menu consists of up to ten sub-items, depending on the parameterisation of the transmitter: >Flow<, >Level<, >Velocity<, >Water Temperature<, >Air Temperature<, >Battery (12V)<, >Analogue Input 1<, >Analogue Input 2<, >Analogue Input 3< and >Digital Input<.

The upper and lower limit values/thresholds and error messages can be set here. When these are reached or occur, the transmitter sends an alarm e-mail to the pre-set e-mail address via the NIVUS WebPortal.

39 Parameter Menu Application



Fig. 39-1 Menu Application

The general parameterisation is described below.

39.1 Menu Measurement Place

The submenu >Measurement Place< is one of the most important basic menus in the parameterisation. The parameter settings of the measurement place include the following basic settings:

- Name of the measurement place
- Type and dimensions of the channel profile
- Possibly fixed settings for sediments (sludge level)
- Low-flow suppression
- System times: damping and stability of the measurement

39.1.1 Name of the measurement place

The measurement place name can be changed here.

Default setting: MP1

When initialising the measurement place name, the default name is automatically deleted after the first letter or number is selected.

- ➡ Write the desired measurement place name in the text field and confirm with "Enter". The measurement place name is transferred to the main menu and displayed there.

39.1.2 Channel Profiles

The transmitter allows the selection of a variety of standardised channel profiles that are predominantly used in practice.

Since older sewer systems in particular often have special designs, the transmitter also offers the option of entering symmetrical and asymmetrical flumes in their dimensions or height/area in the form of a table.

The selected profile is displayed graphically when the 3D preview field is selected. The entered measurements are set in relation to each other in the graphical representation.

Through this visual check, you can immediately determine whether the profile has been created correctly in principle. Especially with free profiles, this direct control is helpful.



Fig. 39-2 Selectable Channel Profiles

➡ Select from the available channel profiles:

- Pipe
- Ellipse
- Egg Profile (1:1.5)
- Rectangle
- Pipe Profiler
- U-Profile
- Trapezoid
- Water Bed
- Height-Width (symmetric)
- Height-Width (asymmetric)
- Height-Area
- $Q=f(h)$

➡ Enter dimensions.

After selecting the profile, the dimension values are entered. The unit of measurement used is factory set in metres [m], but can be changed in the menu >System< / >Country Settings< / >Units< / >Level<.



Fig. 39-3 Example of a channel profile menu

Pipe

This selected shape is suitable for round pipes. This shape selection can also be used for half shells with a maximum filling level of 50 %.

Deformed pipes with asymmetrical height/width ratio can be parameterised using the Ellipse profile.

A separate profile selection is created for U-profiles.

Ellipse

The elliptical profile is mainly used for pipes subject to mechanical loads (lateral pressure or crest pressure). Special channel shapes are also known as elliptical profiles.



Ellipse Profile or Egg Profile

Do not confuse the horizontally and vertically symmetrical ellipse profile with the egg profile.

Egg profiles have different radii in bottom and crest and are therefore only vertically symmetrical.

↻ Enter both dimensions of the elliptical profile.

Egg Profile (1:1.5)

This channel is a "standard egg" according to German DWA A 110 with a width/height ratio of 1:1.5. Pressed or compressed egg profiles must be parameterised using a free profile.

When setting the parameters for a "standard egg" egg profile, only the maximum channel width must be entered. The transmitter automatically calculates the height using the specified 1:1.5 ratio.

Rectangle

With this profile selection, channels with vertical walls and horizontal bottom are parameterised. By simply entering the channel width and height, the parameters are quickly set.

This menu also includes the option to set parameters for a channel with a central dry weather flume.

- Rectangle with Dry Weather Flume

➡ Procedure:

1. Select dry weather flume.
2. Check the >Active< box.
Two more input fields open up.
3. Enter height and diameter of the dry weather flume.
Check the input of the dimensions using the 3D display.

Pipe Profiler

This profile is permanently defined by the NIVUS Pipe Profiler NPP as a full filled pipe. The transmitter automatically reads out parameters such as inside diameter and correction factors.

U-Profile

The U-profile consists of a semicircle at the bottom and vertical walls. The semicircle radius here is 0.5x the channel width. It is entered independently by the system in the calculation. Program profiles with radii > 0.5x the channel width as free profile.

Trapezoid

With this profile selection, it is possible to parameterise symmetrical channels with a horizontal bottom and sloping side walls. Symmetrical channels with a horizontal bottom, sloping side walls and attached vertical walls are also parameterised via this profile setting.

Even with the trapezoid option, it is possible to parameterise a channel with a central dry weather flume.

- Trapeze with Dry Weather Flume

➡ Proceed as described in the rectangle with dry weather flume section on page 84.

Water Bed



Extensive expertise required

Programming a water bed requires extensive knowledge and experience with the functions of the NivuFlow Mobile as well as the hydrological boundary conditions.

We recommend that the programming be carried out by the NIVUS commissioning service or a specialist company authorised by NIVUS.

With this profile, you define the reference point/zero point yourself. Usually, the maximum filling level or the water surface on a bank or channel side is defined as the zero point. Here, the watercourse profile for a specific watercourse section can be stored in the transmitter by means of local measurements.

➡ Enter the freely defined measurement sections one after the other into the table.

Symmetrical profile with Height-Width (Height-Width (sym.))

Any symmetrical profiles can be set in this menu.

After selecting >Table< a table of values appears. A maximum of 32 breakpoint pairs (channel height/channel width) can be entered in this table. These values are automatically calculated in the system and stored internally as a symmetrical profile.

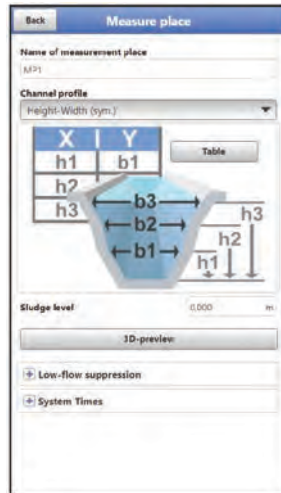

Fig. 39-4 Setting profile parameters using Height-Width (sym.)



Drawing required

A drawing to scale is required for the parameterisation of the channel.

➔ Procedure:

1. Draw a vertical guide line in the centre of the channel on the scaled drawing.
2. Draw horizontal guide lines at the prominent profile change points.
3. Measure the length of these guide lines and then convert them to scale.
4. Start at height "0" to define a channel start.
5. Enter all other breakpoints "free" in height and width.
The distance between the individual height points can be variable. For the profile definition, it is not necessary to specify all 32 breakpoints. The transmitter linearises between the individual breakpoints. In the case of large uneven changes in the channel dimensions, select a smaller breakpoint distance in this change range. After the channel parameterisation has been completed, the entered values are displayed graphically in proportion to each other.
6. Check the input of the dimensions using the 3D display. This visual control option makes any gross programming errors visible.

Free asymmetric Profile with Height-Width (Height-Width (asym.))

In practice, asymmetrical profiles occasionally appear in unusual shapes. The programming option for asymmetric profiles is used for this.



Important note on the viewing direction for free profiles

The viewing direction >Width left< or >Width right< is opposite to the flow direction in the channel.



Drawing required

A drawing to scale is required for the parameterisation of the channel.

➤ Procedure:

1. Draw a vertical guide from the lowest channel point upwards on the scaled drawing.
2. From this guide line, draw horizontal guides to the left and right at the prominent profile change points.
3. Measure the distances of these guide lines from the centre guide line to the right and left respectively.
4. Enter the breakpoints, converted to scale, in the 3-column value table as follows:
Height / Width to the left / Width to the right.
Here, **observe** the previously mentioned important note on the **viewing direction** for free profiles on page 85.
Start at height "0" to define a channel start.
5. Enter all other breakpoints "freely". A maximum of 32 breakpoints is possible. The distance between the individual height points can be variable. For the profile definition, it is not necessary to specify all 32 breakpoints. The transmitter linearises between the individual breakpoints. In the case of large uneven changes in the channel dimensions, select a smaller breakpoint distance in this change range. After the channel parameterisation has been completed, the entered values are displayed graphically in proportion to each other.
6. Check the input of the dimensions using the 3D display. This visual control option makes any gross programming errors visible.

Free symmetrical profile with Height-Area (Height-Area)

Some hydraulic tables contain the value pairs Height-Area instead of Height-Width for symmetrical channels. In this case, enter the value pairs in the selected Height-Area table.

Here, **observe** the previously mentioned important note on the **viewing direction** for free profiles on page 85.

The rest of the procedure is identical to the programming of the Height-Width profile. Only a graphic representation of the programmed profile is not possible here.

Q/h-Function ($Q=f(h)$)

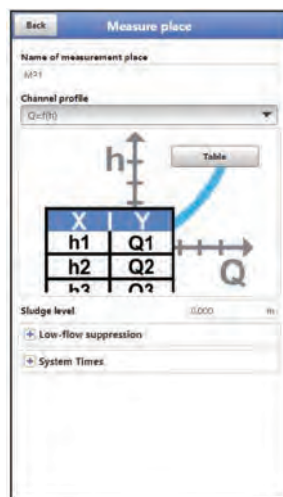

Fig. 39-5 Q/h-Function

This function differs significantly from the previously described channel profiles. When selected, neither the channel profile nor the flow velocity are taken into account. **Communication** with any connected flow velocity sensors is **switched off**. Therefore, the missing flow velocity value is not taken into account in any error diagnosis.

The system operates a pure Q/h function. This means that a defined flow rate value is displayed depending on the currently measured level. This value is entered height-related in a value table.

A maximum of 32 height-related breakpoints can be specified in this table. The transmitter linearises between the individual breakpoints.

39.1.3 Sludge Level

In horizontal pipelines, depending on the measured medium and the flow velocity, deposits (sediments) may occur on the pipe bottom.

In this parameter, a fixed sediment height (deposition) in the pipe can be entered as >Sludge Level<. The entered sludge level is calculated as the "non-moving, bottom lying partial area of the channel with a horizontal surface". This height is subtracted from the total wetted hydraulic area before the flow calculation.

In applications where the flow rate is measured from above by means of a float, and the level is recorded with an i-Sensor or air-ultrasonic sensor **and simultaneously** with a water-ultrasonic sensor, the sludge level can be determined and output from the difference between the two level sensors, taking into account the immersion depth.

39.1.4 3D Preview

If the 3D preview is selected, the parameterised measurement place with the respective sensors can be displayed.

39.1.5 Low-flow suppression

This parameter is used to suppress the slightest movements or apparent quantities. The main field of application is the measurement of discharge rates in structures that are permanently dammed.

- Check >Active< and enter the desired value for >Q suppressed<, >v suppressed< or >h suppressed<.



Fig. 39-6 Low-flow suppression

Low-flow suppression prevents the detection of the slightest changes in velocity. These changes can cause large apparent fluctuations in the measured volume over a longer period of time.

Flow velocities that are smaller than this parameterised value are "suppressed" and therefore no flow rate is detected. The transmitter does not store a value.

- **>Q suppressed<**
Specify the flow value as positive value.
Negative values are not possible. The entered value is interpreted as an absolute value and has both a positive and negative effect. If the current, calculated measurement values are smaller than this entered value, the system automatically sets the measurement values to "0".

- **>v suppressed<**
Low-flow volumes can be suppressed here for applications in large profiles and with high filling levels. The slightest changes in velocity can cause large apparent changes in volume over a longer period of time, which cannot be suppressed using the value >Q suppressed<. If the flow velocities are lower than this parameterised value, the system automatically sets the measurement values to "0".
This also makes the calculated volume "0".
Only a positive value can be specified. The entered value is interpreted as an absolute value and is effective for both positive and negative velocities.
- **>h suppressed<**
Lower limit values for fill levels can be entered here. If the real levels are smaller than this entered value, the system automatically sets the measurement values to "0". This means that no area is calculated and no volume calculation can be carried out.

39.1.6 System Times

For the system times, either "Minimum Measurement Duration" and "Maximum Measurement Duration" or "Damping" and "Stability" can be set depending on the set operating mode.

For "Cycle Mode", "Event Mode" and "Event Continuous Mode":

- **Minimum Measurement Duration**
This menu item allows you to set the minimum required measuring time in seconds. The time range is entered in steps of 1 second.
Default setting: 5 s
- **Maximum Measurement Duration**
This menu item allows you to set the maximum possible measuring time in seconds. The time range is entered in steps of 1 second.
Default setting: 10 s

For "Continuous mode":

- **Damping**
This menu point allows you to change the damping of the display and analogue output in seconds.
The damping refers to all level and flow velocity values that are available as input values. Individual values cannot be selected and damped differently.
All measurement values are stored over the specified time range and a moving average is calculated for each individual measurement value. This average value is used for further calculation of the flow rate.
The time range is entered in steps of 1 second.
Default setting: 30 s
- **Stability**
The stability is the time span within which the transmitter bridges the values without correct measurement, i.e. in case of invalid level and flow velocity values.
The transmitter operates during this period with the last valid measured value. If the specified time span is exceeded without a correct value being recorded, the transmitter goes to the measured value "0", taking into account the set damping. The transmitter does not store a value.
The time range is entered in steps of 1 second.
Default setting: 30 s

39.2 Menu h-Sensors

After setting the measurement place parameters, the level sensor(s) used must be defined and their measurement ranges must be set.

The level sensors are parameterised in the >h-sensors< submenu.

39.2.1 h-Sensor Types



Fig. 39-7 Selecting the h-Sensor Types

A selection of level sensors can be found in the >h-Sensor Types< field.

- Open the >h sensor types< parameter and select the sensor type that is connected to the transmitter.
In the vast majority of applications, it is sufficient to select a level sensor.
- When using several level sensors (e.g. i-Sensor and 2-wire level), set a tick for each sensor.



Sensor connected?

After completing the parameterisation, the transmitter detects the missing or incorrectly selected sensor and issues an error message.

The number of selected sensors corresponds to the number of individual level measurement ranges over the entire measurement cross-section. Only one level sensor per measurement can provide the valid value for the measurement. Incorrect combinations and combinations that do not make sense are not accepted by the transmitter.

A maximum of three different level sensors can be selected.

The sensor measurement ranges can be set below the channel graphic.



Sensor Detection

The transmitter does not recognise which type of sensor the 2-wire level sensor is. This is why the representation of the sensor in the display is not decisive for the measurement range.

As standard, the transmitter displays the 2-wire level sensor as an ultrasonic sensor from above.

Example

Air-ultrasound sensor at the top with sound direction downwards; pressure sensor and water-ultrasound on the bottom of the channel.

The level sensors are displayed in the channel shape that was previously parameterised under the measurement place.



Fig. 39-8 Selecting the Level Sensors

The following level sensors are available:

- **Integrated Pressure**
The level is measured from below using a combi sensor with integrated pressure measurement cell (Type V2D or V2U).
Side mounting, e.g. in case of sedimentation or high dirt load, is possible.
The Level measurement in overflow conditions is possible too.
- **2-wire Level**
The level is measured via an external 2-wire sensor which is supplied by the transmitter.
Example: pressure probe Type NivuBar Plus
The use of a 0/4...20 mA signal from an external transmitter such as NivuMaster or MultiRanger is also activated via this selection.
- **i-Sensor**
Connection of the NIVUS i-series ultrasonic sensor via analogue input AI1.
- **Air Ultrasound NIVUS**
The level measurement is carried out from above using an air-ultrasonic sensor Type DSM-L0. This sensor is used for the measurement of low levels. The level sensor must be installed exactly in the middle of the channel crown, ($\pm 2^\circ$) parallel to the water surface.
- **Water-Ultrasound integ.**
The level is measured from below using a combi sensor Type CSP-V2H or CSP-V2U by water ultrasound. This sensor type is used to detect the discharges in the medium part filled area. The combi sensor must be installed exactly in the centre of the channel bottom ($\pm 2^\circ$). If there is a risk of sedimentation or sludge deposits, the sensor can be placed off-centre. In this case, the water ultrasound from below must not be used!
The measurement may fail. Select a different level sensor (ultrasound from above or pressure measurement cell) for this case.

- Water-US Sludge Level**
 The water-US sludge level sensor is only listed in the pull-down menu if the "Float" was previously selected in the >v-Sensors< menu.
 With this sensor, sedimentation levels can be determined if the measurement technology is suitable.
 The selection "Water-US Sludge Level" is only possible in combination with another height measurement for partial filling or for full filling (i-Sensor, 2-wire sensor or NIVUS air-ultrasonic sensor).
 A water-ultrasonic combi sensor Type CSP-V2H with water ultrasound **from above** is used. This combi sensor is either permanently installed (e.g. for full filling via fixed setting) or is attached using a float for partial filling.
- Fixed Value**
 This selection is intended for permanently full pipes and channels. No level measurement is required for these applications. The constant level is given to the measurement system and used for flow calculation.
 This parameter can be used as a support for the initial commissioning or for tests without an available level value.

39.2.2 Definition of Measurement Ranges

Depending on the type and number of selected sensors, a vertical coloured bar appears on the right side of the displayed channel profile. With this bar, the working range of the individual sensors is marked in the corresponding colour section.

- Measurement Range
 - Top: red
 - Centre: yellow
 - Bottom: green
- Number of sensors used
 - only one: solid green bar
 - two: colour combination green/red
 - three: colour combination green/yellow/red

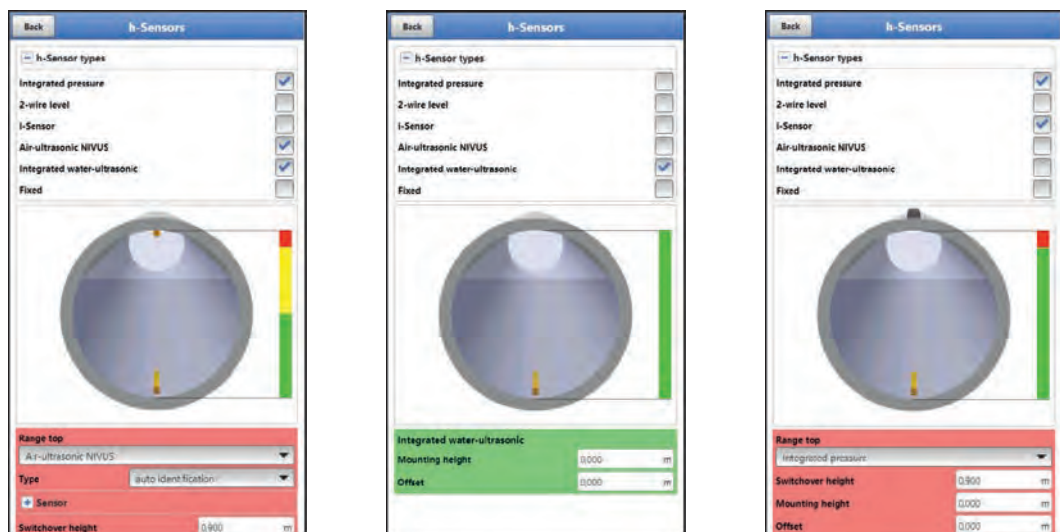

Fig. 39-9 Selecting sensors and display of sensor measurement ranges

Depending on the type and number of selected sensors, one to three coloured parameterisation areas are displayed below the channel, depending on the type and number of selected sensors. The colour of these parameterisation areas corresponds to the colour of the vertical bar (as described before) and the assigned sensors.

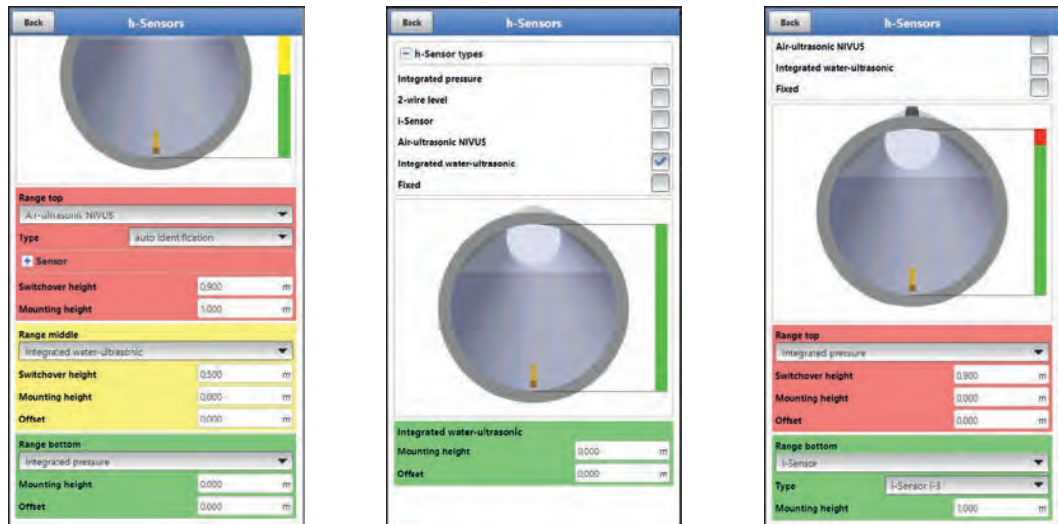

Fig. 39-10 Representation of the parameterisation ranges

The transmitter automatically assigns the sensors to the appropriate parameterisation range. The assignment depends on the parameterised channel shape.

- Air-Ultrasound: measurement range bottom
- Pressure Measurement Cell: measurement range top
- etc.

This assignment can be changed as desired. When selecting the assignment, only those sensors are displayed that were previously selected. (see Fig. 39-8).

A level sensor can also be used for two or three parameterisation ranges. In this case, the other activated level measurement values are only stored internally but are not used for calculation.

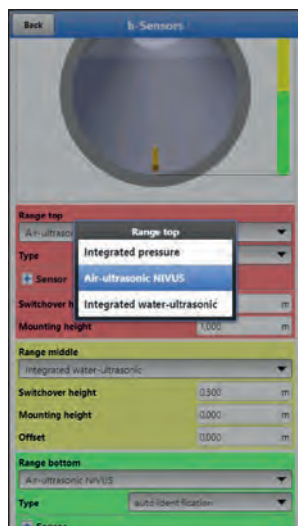

Fig. 39-11 Assignment Level Sensor to Parameterisation Range

Each parameterisation range can be changed in its range size. Make this change of range by changing the according >Switchover Height<.



Specify positioning values precisely

Make sure that the values of the positioning of the individual sensors must be specified precisely.

Sensors with integrated pressure measurement cell must be placed at the lowest point of the channel bottom (sensor Types CSP-V2D, CSP-V2U and CSM-V1D).

For sensors that are mounted on an elevation (block or similar) or on a berm, a different value must be entered for the mounting height. Measure the distance from the **lower edge** of the sensor mounting plate to the lowest point of the application. Enter this value as "Mounting Height".

For sensors mounted at an angle (e.g. when mounted laterally in a pipe or trapezoidal channel), the **centre** of the sensor mounting plate is the reference value.

The value of the sensor positioning is automatically adopted for the position of the v-sensor as well as for the determination at v-crit (see Chapter "39.3.6 v-Determination low Levels").

An additional offset can be entered to adjust the pressure sensors.



Fig. 39-12 Setting the parameters of the integrated pressure sensor

The same specifications apply to flow velocity sensors with integrated water-ultrasonic sensor. Measure the distance from the top edge of the sonic converters.

These differences are automatically recognised by the system when the sensor is connected and taken into account accordingly.

39.3 Menu v-Sensors

The third important point, in addition to the measurement point and the level sensors, is the parameterisation of the flow velocity sensors. In addition to type and number of sensors, this menu also includes the spatial position. Information in this menu item refers to the defined channel in terms of shape as well as spatial dimension (see Chapter "39.1.2 Channel Profiles").



Observe the real Mounting Direction

In contrast to the usual way of looking at it, the user looks with the flow direction, the v-sensors point in the direction of the user.

When setting the parameters, observe that the real installation is rotated by 180°.

39.3.1 Number of Flow Velocity Sensors

Up to three flow velocity sensors can be connected to a NivuFlow Mobile 750 transmitter.

For a 3-path measurement, the third flow velocity sensor must then be selected manually.

39.3.2 Selecting the Sensor Types

The selection includes four different sensor types or automatic identification:

- CSM Wedge
- CSM Wedge + Pressure
- CSP Wedge
- CSM Pipe
- Auto Identification

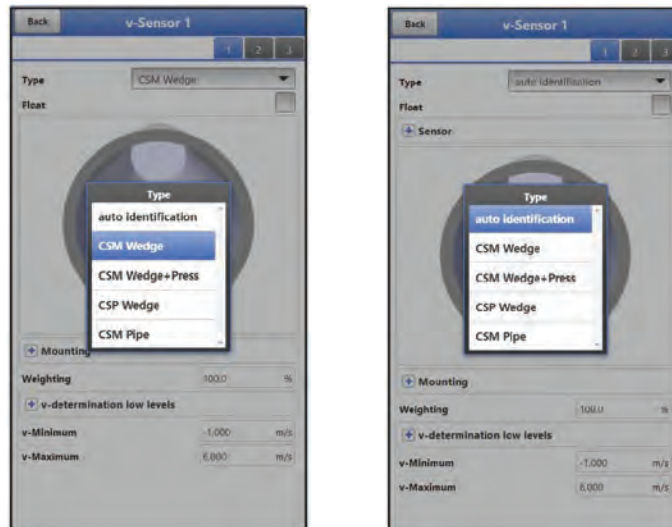

Fig. 39-13 Selecting the sensor types

If "Auto Identification" is selected, the transmitter determines the connected sensor and enters its serial and article number under >Sensor<.

In addition, all important parameters such as piezo frequency, angle, maximum measurement range, offset etc. are stored. If the sensors are replaced, no new sensor parameterisation is required; the transmitter can also adopt all details for the new sensors.

39.3.3 Float

The selection "Float" for the sensors changes the following input options for the mounting position (see Chap. "39.3.4 Mounting Position of Sensors").

The mounting position of a float always adapts to the different medium depths in the channel due to its special fastening.

39.3.4 Mounting Position of Sensors

For mounting the v-sensors, additional parameters can be entered for the application.

These specifications are mainly intended for installation positions that deviate from the factory setting.

Via the normal **setting of the mounting (position)**, the three parameters >Mounting Height<, >Distance Centre< and >Mounting Angle< to be adjusted to each other can be entered.

Selection Flush with Wall

If wedge sensors are mounted directly on the wall of the inclined/curved surface, a tick is set here and the mounting parameters are reduced. However, this is only possible with the following channel profiles:

- Pipe

- Egg Profile
- U-Profile

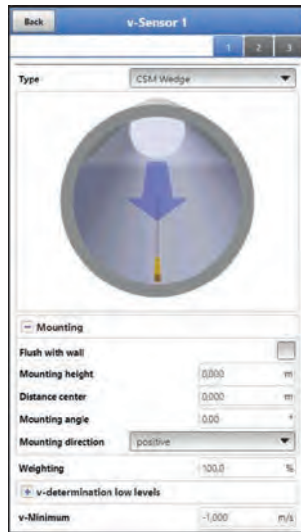

Fig. 39-14 Setting Parameters using Height, Distance and Angle

If the sensors are **installed flush with the wall**, only the mounting angle can be entered (1-parameter programming).

The use of the 1-parameter programming only using the mounting angle requires a beam angle to the centre of the circular profile/circular section and requires the installation mentioned before. It significantly facilitates the correct setting of parameters.

➡ Procedure:

1. Check the >Flush with wall< selection box.
The following input fields will be reduced. Only the input field >Mounting Angle< is active.
2. Specify the sensor mounting angle.
3. Check entry.
In the graphic, the sensor is displayed in the entered beam angle.



Fig. 39-15 Setting Parameters by Angle Input

Input Field Mounting Height (only possible if "Flush with Wall" is not activated/available)

➡ Procedure:

1. Measure the distance from the lower edge of the mounting plate (v-sensor) to the lowest point of the channel bottom.
2. Enter the measured distance in the field >Mounting Height<. **Default setting:** units in METER.
It is not necessary to enter a value if the sensor is screwed directly to the floor at the lowest point.

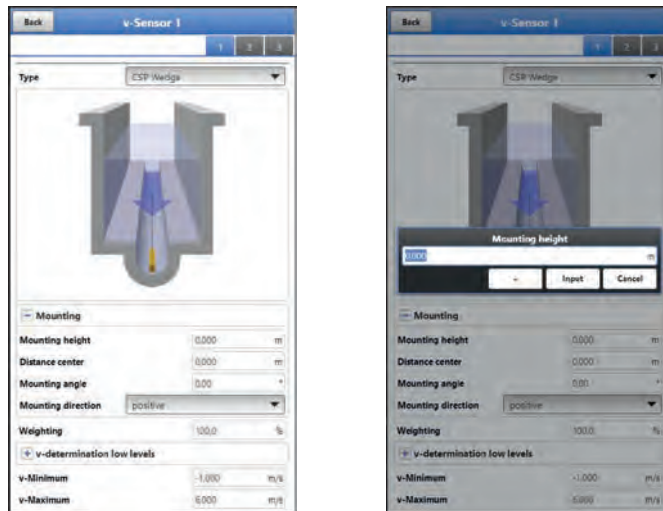

Fig. 39-16 Setting the Mounting height Parameters

In structured channel profiles, e.g. channels with **dry weather flume** and **berm**, the lowest point in the channel corresponds to the zero point. The lowest point in this case is the bottom of the dry weather flume.

If a sensor has to be mounted on a block due to of the **risk of sludge deposits** or **sedimentation**, this distance must be also taken into account.

➡ Procedure:

1. Determine the position of the sensors in relation to the zero point of the application. The reference point is the lower edge of the mounting plate, for pipe sensors the horizontal area of the sensor head.
2. Enter this distance in the field >Mounting Height<.

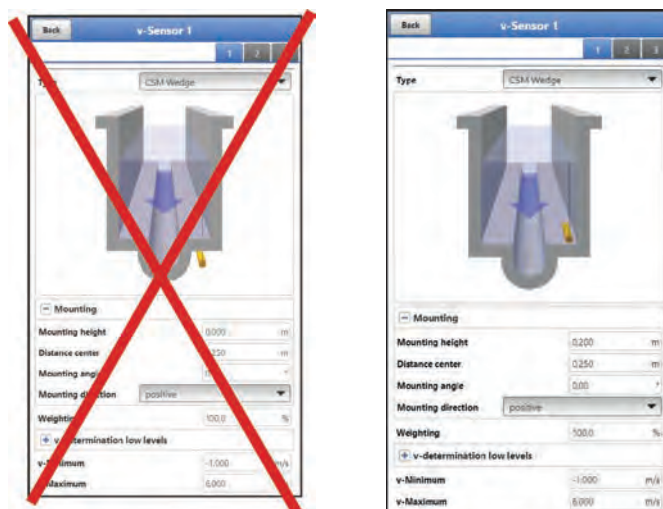

Fig. 39-17 Too low and correctly parameterised mounting height v-sensor

Input Field Immersion Depth (only if "Float" is selected)

Here the distance between the water surface and the top edge of the water-ultrasonic sensor or the top edge of the sensor plate must be measured and entered. If the water-ultrasonic sensor floats directly on the water surface, the value is indicated as "0".

Input Field Distance Centre (only possible if "Flush with Wall" is not activated/available)

The sensor parameters are set as follows:

- v-sensor 1 is always in the centre

The calculation in the transmitter is always based on the central installation of the v-sensor. If the v-sensor is mounted off-centre, this offset must be entered in the >Distance Centre< field.

- Entering a negative value moves the sensor to the left.
- Entering a positive value moves the sensor to the right.

The value refers to the centre of the application.

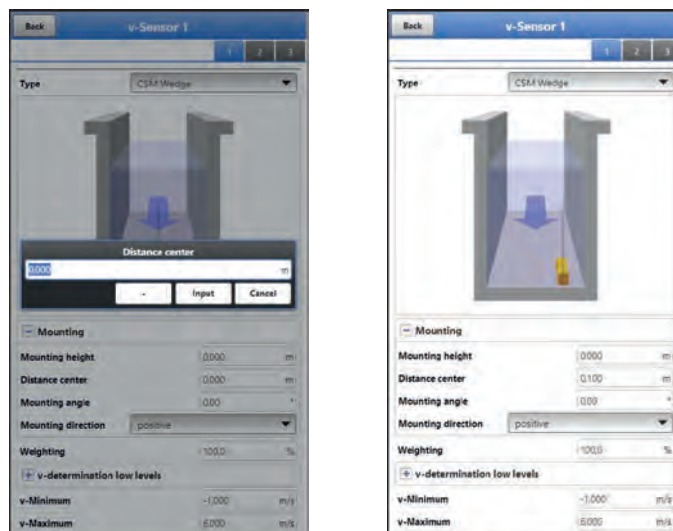

Fig. 39-18 Entering the Sensor Position, relative to the Application Centre

Input Field Mounting Angle

Default setting: v-sensor always measures the flow velocity vertically upwards.

In some applications it is necessary to install the sensor at an angle or even horizontally:

- inclined at the slope of a trapezoidal channel
- on the side of channel walls
- in the rounding of a pipe or U-profile

In this case, the changed beam angle must be stored in the transmitter. The reference point is the vertical, upward beam of the ultrasonic signal.

The following applies to the parameterisation of the **inclination of the beam angle** (against the direction of flow):

- negative value: slope to the left
- positive value: slope to the right
- 90°: horizontal beam
- 180°: beam downwards

Mounting Direction

Changing the mounting direction is possible without any problems in most applications and is also necessary in some applications: If stone chipping may occur in the medium, changing the mounting direction can remedy the situation and enable a stable measurement.

Irritations may occur only at very low levels and the measurement values become unstable.

Default setting: mounting direction of the sensors >positive< (measurement against the flow direction).



Fig. 39-19 Option to change the Sensor Mounting Direction

39.3.5 Weighting

When using several flow velocity sensors, the value of each flow velocity sensor to the measurement result of the average total velocity must be defined. The entry is made in the >Weighting< field and is specified in %.

Default setting: 100 %.



Expert knowledge required

The value of the weighting depends on the application and the sensor position.

Such applications require extensive knowledge of fluid mechanics and require the use of NIVUS commissioning personnel or an authorised specialist company.

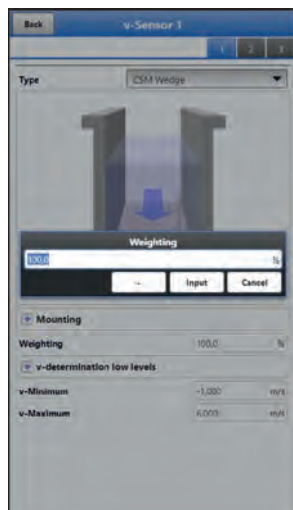

Fig. 39-20 Weighting v-Sensors

39.3.6 v-Determination low Levels

Physically and due to their design, the flow velocity sensors can no longer measure the flow velocity when the filling level falls below a minimum level. This minimum level is:

- for Type CSM: 3 cm
- for Type CSM-D: 5.5 cm
- for Type CSP: 8 cm

Unfavourable applications or the elevated installation of the sensors may increase this value. This level is called **h-crit**.

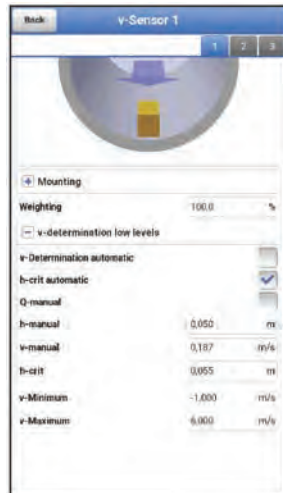

Fig. 39-21 Submenu: v-Determination low Levels

The >v-Determination low Levels< menu facilitates the recording of temporarily low flow rates (e.g. nightly discharges, extraneous water or similar).

Prerequisite for this function:

- No backwater in the application

>v-Determination Automatic<

Working principle of the function:

After commissioning, the NFM initially operates without a discharge curve up to the h-crit value.

If a filling level range of 6 cm above h-crit is "passed through" when the tendency is falling, the application coefficient determined at h-crit is entered under v-crit.

Afterwards, the NFM works under h-crit with the discharge curve from the determined application coefficient.

If >v-Determination Automatic< remains activated, the entered value is checked and, if necessary, corrected the next time the determination range is "passed through".

Default setting: function activated (box checked).

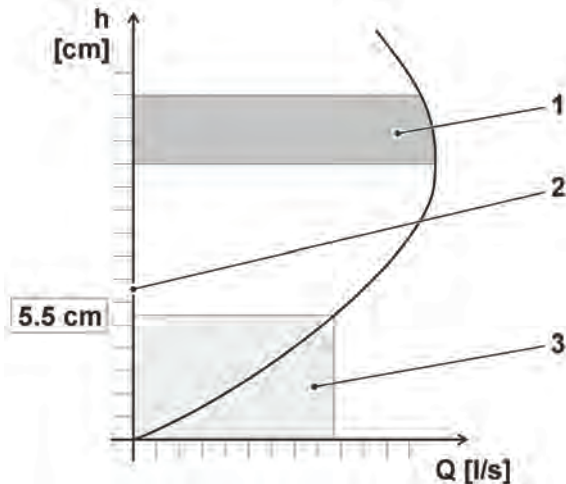

- 1 Determination of the Application Coefficient
- 2 h-crit
- 3 Range of the automatic Q/h relation

Fig. 39-22 v-Determination Automatic (using the CSM-D as example)

>h-crit automatic<

The automatic calculation includes the information of the sensor type and the parameterised mounting height (see Chapters "39.3.4 Mounting Position of Sensors", Fig. 39-16).

If the function is deactivated, h-crit can be adjusted manually.

Default setting: function activated (box checked).

>Q-manual<

If a specific flow rate value is to be entered manually, the field must be activated (ticked). Details see page 102.

Default setting: function deactivated box unchecked.

>h-manual<

This input field is used to manually enter a filling level. This level is related to the flow velocity value >v-manual< or >Q-manual<.

Default setting: >h-manual< is "0".

>v-manual<

This input field is used to manually enter a flow velocity.

This function is available only when >Q-manual< is deactivated (box unchecked).

This flow velocity value is a part of >h-manual<. The flow velocity value entered can be determined for the corresponding level, e.g. by means of a hydrological programme or with the help of a dam-up in the channel and the simulation in the diagnostics menu.

➡ Procedure for determination using dam-up and simulation:

Info:

If the level is below the technically possible minimum value (see introduction of chapter "39.3.6 v-Determination low Levels"), the flow velocity and the flow rate cannot be determined.

- Note the current level (in the example 0.050 m).

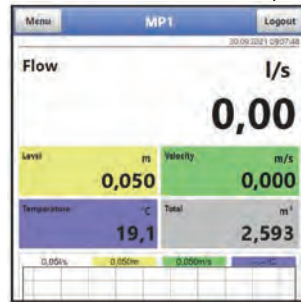

- Create dam-up with the aid of a sandbag (or something similar) until a level is reached in which the flow velocity can be measured stably. This can be recognised by a stable (no jumping) velocity reading in the display or by the fact that there are no visible eddies in front of the sensor.
- When the velocity is stable, note the displayed flow rate value (1.40 l/s in the example).

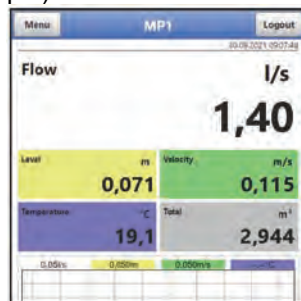

- Clear the dam-up that has been created.
- Open the menu >Application< / >Diagnostics< / >Simulation<.
- In the "Level" field, set the previously noted level value (before damming up) (0.050 m in the example) by pressing the "- -", "-", "+", and "+ +" keys.
- Adjust the velocity in the "Velocity" field with the "- -", "-", "+", and "+ +" keys until the previously noted flow rate value (1.40 l/s in the example) is reached. Note the adjusted/determined velocity value (here: 0.187 m/s).



- In the menu >Application< / >v-Sensors< under >v-Determination Low Levels< enter and save the values determined (in the simulation) for "h-manual" (in the example 0.050 m) or "v-manual" (here: 0.187 m/s).

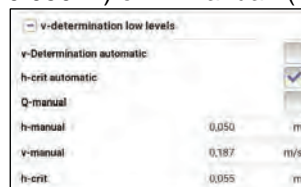

Info:

If values have been entered for >v-manual< according to this procedure, they are retained even when deactivated.

By setting or removing the tick (activate/deactivate) at >v-Determination automatic<, the user can choose at any time whether the transmitter should calculate with the automatic values or with the manually entered ones.

>Q-manual<

This input field is used to manually enter a flow rate value.

The flow value is part of >h-manual< and can be determined via a build-up.

This function is available only when >Q-manual< is activated (box checked).

➡ Procedure for determination using dam-up:

Info:

If the level is below the technically possible minimum value (see introduction of chapter "39.3.6 v-Determination low Levels"), the flow velocity and the flow rate cannot be determined.

1. Note the current level (in the example 0.050 m).

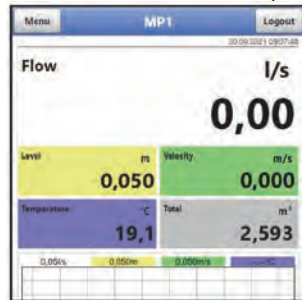

2. Create dam-up with the aid of a sandbag (or something similar) until a level is reached in which the flow velocity can be measured stably. This can be recognised by a stable (no jumping) velocity reading in the display or by the fact that there are no visible eddies in front of the sensor.
3. When the velocity is stable, note the displayed flow rate value (1.40 l/s in the example).

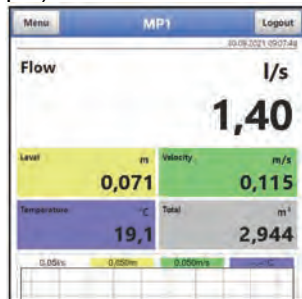

4. Clear the dam-up that has been created.
5. Open the menu >Application< / >v-Sensors<.
6. Under >v-Determination Low Levels< enter the measured flow rate during the dam-up (in the example 1.40 l/s) in >Q-manual<. Enter the filling level (which should be identical before and during the dam-up) (in the example 0.050 m) in >h-manual<. Save the values.

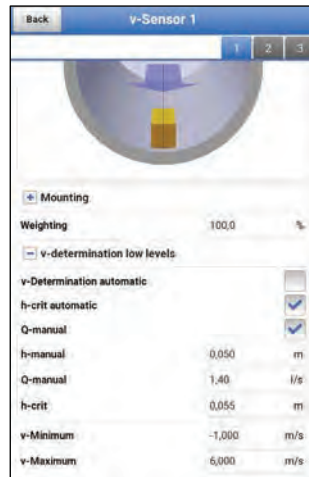

Info:

If flow values have been entered for >Q-manual< according to this procedure, they are retained even when deactivated.

By setting or removing the tick (activate/deactivate) at >Q-manual<, the user can choose at any time whether the transmitter should calculate with the automatic flow values or with the manually entered ones.

>h-crit<

This input field is used for the v/h calculation. To do this, enter the level from which the system is to switch to v/h calculation.

>h-crit< is only active if >h-crit automatic< is deactivated. Otherwise it is visible but not selectable.

>v-crit<

Entered value after automatic determination.

39.3.7 v-Minimum and v-Maximum

The settings of >v-Minimum< and >v-Maximum< set the limit values for the velocity measurement. Individual higher and lower velocities are ignored by the transmitter and not displayed. If deviations are measured permanently, the transmitter displays them as "0" and only displays the next realistic measurement results again.

Values from -1 to +8 m/s can be set.

Default setting:

- v-Minimum: -1 m/s
- v-Maximum: 6 m/s

A classic application is the prevention of the evaluation of negative flow velocities (backflow). In this case, the maximum value of the negative flow velocity is simply set to "0".



Specifications show upper limit

An increase of the possible flow velocity evaluation beyond the technical limits given in chapter "18 Specifications" is not possible and the device adopts the respective possible limit values.



Fig. 39-23 Limiting the Velocity Evaluation

39.4 Menu Inputs and Outputs (analogue and digital)

In this menu, the functions of the analogue and digital inputs and outputs are defined. Further parameter settings such as measurement and output spans, offsets, limit values, error reactions etc. are also possible in this menu.

➡ Open menu >Inputs/Outputs Inputs< via >Main Menu< / >Application<.

The Inputs/Outputs menu is divided into four sections:

- Analogue Inputs
- Analogue Outputs
- Digital Inputs
- Digital Outputs

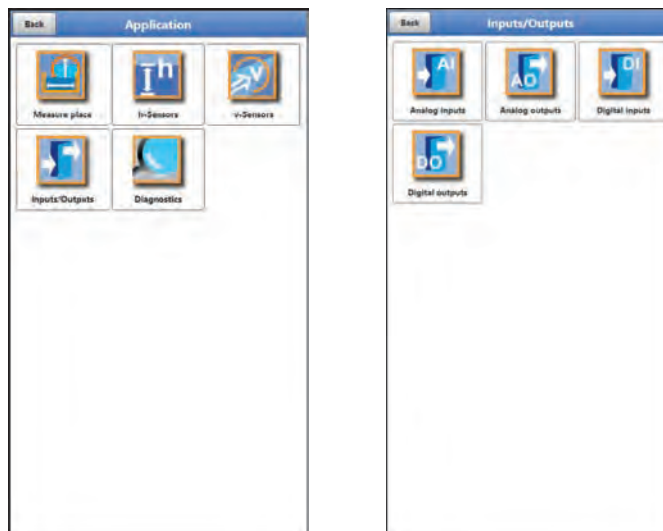

Fig. 39-24 Menu Input/Outputs

39.4.1 Analogue Inputs

The transmitter is equipped with three analogue inputs. These are shown in the top right corner of the display and can be selected individually. The selected analogue input is highlighted in colour and the name is shown in clear text in the title bar.

Default setting: Input inactive

Alternatively, the transmitter can be used as an additional data logger for measured values from external systems or to supply analogue sensors. The actual task as a flow transmitter is not affected by this.



Analogue input 1 is not always available as a data logger

If a 2-wire level sensor or i-Series sensor was selected when selecting h-sensors in Chap. "39.2 Menu h-Sensors", analogue input 1 is not available for selection for use as an external data logger.

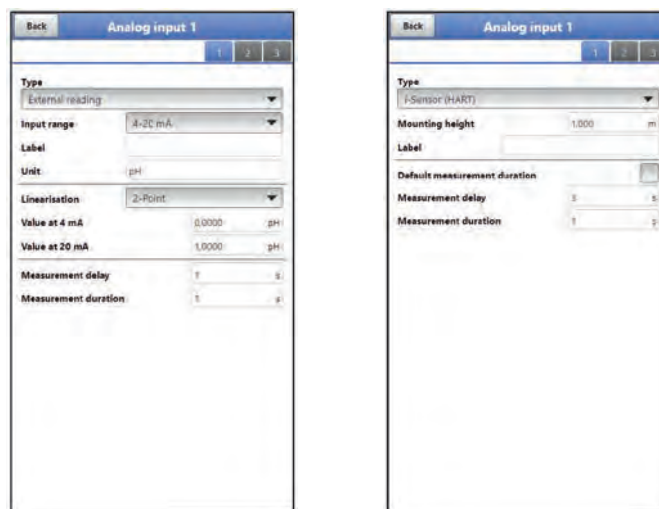

Fig. 39-25 Analogue input as External Measurement Value / i-Sensor (HART)

The following values must be selected/entered in **>External Measurement Value<**.

- Selection/input options:
 Input range: **>0-20 mA<** or **>4-20 mA<**
 Designation: manual input
 Unit: manual input
 Linearisation: **>2-Point<** or **>Table<**
 For **>2-Point<** linearisation: manual input of the values for 4 or 20 mA
 For **>Table<** linearisation: enter the number of **>Entries<** manually, then select **>Table<**, fill in and confirm
 Measurement delay: manual entry of values
 Measurement duration: manual entry of values

The following values must be selected/entered in **>i-Sensor (HART)<** (only for analogue input 1).

- Selection/input options:
 Mounting height: manual input
 Designation: manual input
 Standard measurement duration: tick if the box is unchecked, manual entry of values for measurement delay and measurement duration

39.4.2 Analogue Outputs

The transmitter is equipped with an analogue output 0-10 V.

Default setting: Output inactive

The following different functions can be assigned to the analogue output.



Fig. 39-26 Activation analogue output

- **Flow**
The flow rate of the application (calculated from average flow velocity and wetted cross-section) is output at the selected analogue output.
 - Selection/input options:
Output range: >0-5 V< or >0-10 V<
Value at 0 V: manual input
Value at 10 V: manual input
Value at error: >0 V< or >Hold Value< or >10 V<
- **Level**
The level of the current height range is output at the selected analogue output.
 - Selection/input options:
Output range: >0-5 V< or >0-10 V<
Value at 0 V: manual input
Value at 10 V: manual input
Value at error: >0 V< or >Hold Value< or >10 V<
- **Flow Velocity**
The average calculated flow velocity used to calculate the current flow rate is available at the selected analogue output.
 - Selection/input options:
Output range: >0-5 V< or >0-10 V<
Value at 0 V: manual input
Value at 10 V: manual input
Value at error: >0 V< or >Hold Value< or >10 V<
- **Water Temperature**
The medium temperature determined by the flow velocity sensor can be output at the selected analogue output.
 - Selection/input options:
Output range: >0-5 V< or >0-10 V<
Value at 0 V: manual input
Value at 10 V: manual input
Value at error: >0 V< or >Hold Value< or >10 V<

- **Air Temperature**
The measured air temperature can be output at the selected analogue output.
 - Selection/input options:
Output range: >0-5 V< or >0-10 V<
Value at 0 V: manual input
Value at 10 V: manual input
Value at error: >0 V< or >Hold Value< or >10 V<
- **External Reading**
Measurement values applied to the analogue input and linearised, if applicable, can be output here again.
 - Selection/input options:
Analogue input: >Input 1< or >Input 2< or >Input 3<
Output range: >0-5 V< or >0-10 V<
Value at 10 V: manual input
Value at error: >0 V< or >Hold Value< or >10 V<
- **Sensor Velocity**
If multiple flow velocity sensors are used and the average flow velocity of the individual measuring paths is to be determined, the desired flow velocity sensor can be selected and its measured value output in analogue form.
 - Selection/input options:
Sensor: >Sensor 1< or >Sensor 2<, depending on how many sensors are connected
Output range: >0-5 V< or >0-10 V<
Value at 0 V: manual input
Value at 10 V: manual input
Value at error: >0 V< or >Hold Value< or >10 V<

39.4.3 Digital Inputs

The transmitter is equipped with one digital input.

Default setting: Input inactive

The following different functions can be assigned to the digital input.



Fig. 39-27 Activation Digital Input

- **Runtime**
The duration of the signal present at the digital input is recorded and stored by the system. This recording is used, for example, for pump or device running times. The running time is stored in seconds/recording interval.
 - Selection/input options:
Logic: >not inverted< or >inverted<
Designation: manual entry

- **Impulse Counter**
The number of the signals present at the digital input is counted and stored by the system. The evaluation of the counting impulse is done by detecting the change of state of the digital input (1->0 or 0->1).
 - Selection/input options:
Edge:
>rising< (change of state from "0" to "1") or
>falling< (change of state from "1" to "0")
Designation: manual entry

- **Recording**
Recording of the measurement values and their status changes for diagnostic purposes. The evaluation is done by detecting the change of state of the digital input (1->0 or 0->1).
 - Selection/input options:
Logic: >not inverted< or >inverted<
Designation: manual entry

39.4.4 Digital Outputs

The transmitter is equipped with one digital output.

Default setting: Digital output inactive

The following different functions can be assigned to the digital output.

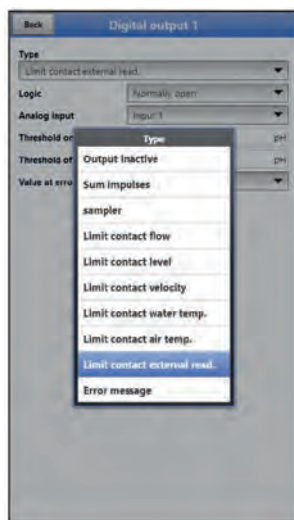

Fig. 39-28 Activation Digital Output

- **Sum Impulses**
Quantity-proportional sum impulses are output.
 - Selection/input options:
Logic: >Normally open< or >Normally closed<
Negative sum impulses: check box
Quantity: manual input
Duration: manual input

- **Sampler**
In connection with a customer's sampler, its cyclic control can be defined.
 - Selection/input options:
Logic: >Normally open< or >Normally closed<
Level: manual input, minimum level required for sampling
Quantity: manual input, required quantity for sampling
Duration: manual input, impulse duration for coordination with the sampler
- **Limit Contact Flow**
A digital signal is output when the entered high flow limit value is exceeded.
If the flow falls below the low flow limit value, this digital signal is reset = hysteresis function to prevent fluttering outputs.
 - Selection/input options:
Logic: >Normally open< or >Normally closed<
Threshold On: manual input
Threshold Off: manual input
Value at error: >On< or >Off< or >Hold Value<
- **Limit Contact Level**
A digital signal is output when the entered high level limit value is exceeded.
If the flow falls below the low level limit value, this digital signal is reset = hysteresis function to prevent fluttering outputs.
 - Selection/input options:
Logic: >Normally open< or >Normally closed<
Threshold On: manual input
Threshold Off: manual input
Value at error: >On< or >Off< or >Hold Value<
- **Limit Contact Velocity**
If the entered high velocity limit value is exceeded, a digital signal is output.
If the flow falls below the low velocity limit value, this digital signal is reset = hysteresis function to prevent fluttering outputs.
The calculated average flow velocity (also calculated from several sensors) is used.
 - Selection/input options:
Logic: >Normally open< or >Normally closed<
Threshold On: manual input
Threshold Off: manual input
Value at error: >On< or >Off< or >Hold Value<
- **Limit Contact Water Temperature**
A digital signal is output when the entered high water temperature limit value is exceeded.
If the flow falls below the low water temperature limit value, this digital signal is reset = hysteresis function to prevent fluttering outputs.
 - Selection/input options:
Logic: >Normally open< or >Normally closed<
Threshold On: manual input
Threshold Off: manual input
Value at error: >On< or >Off< or >Hold Value<
- **Limit Contact Air Temperature**
A digital signal is output when the entered high air temperature limit value is exceeded.
If the flow falls below the low air temperature limit value, this digital signal is reset = hysteresis function to prevent fluttering outputs.
 - Selection/input options:
Logic: >Normally open< or >Normally closed<
Threshold On: manual input

Threshold Off: manual input
Value at error: >On< or >Off< or >Hold Value<

- **Limit Contact external Reading**
A digital signal is output when the entered high external reading limit value is exceeded. If the flow falls below the low external reading limit value, this digital signal is reset = hysteresis function to prevent fluttering outputs.
 - Selection/input options:
Logic: >Normally open< or >Normally closed<
Analogue input: >Input 1< or >Input 2< or >Input 3
Threshold On: manual input
Threshold Off: manual input
Value at error: >On< or >Off< or >Hold Value<

- **Error Message**
By activating the individual selection fields (check box) using the push button, the individual error types to be output can be assigned to the digital output. Furthermore, the output logic can be changed between normally closed and normally open function.
 - Selection/input options:
Logic: >Normally open< or >Normally closed<
Error mask:
v-Measurement: check box
h-Measurement: check box
T-Measurement: check box
External Reading: check box
System: check box

39.5 Menu Diagnostics

The diagnostics menu is described separately in Chapter "Diagnostics" starting on page 150 of the instruction manual.

40 Parameter Menu Data

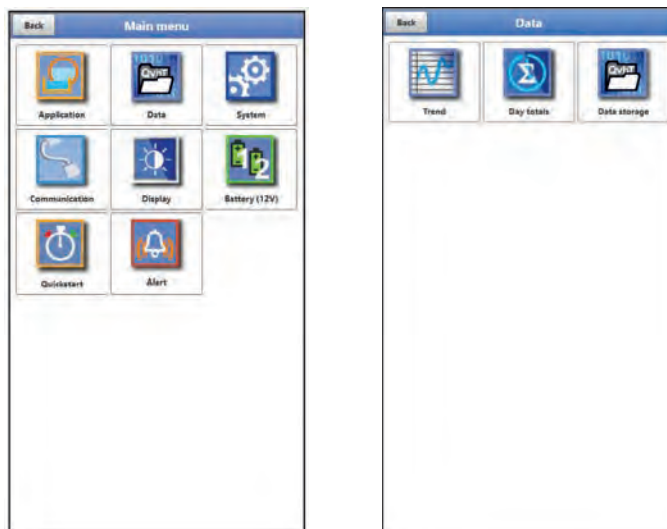

Fig. 40-1 Menu – Data

40.1 Menu Trend

The trend display is a visualising recorder function. When the trend display is selected, current and previously stored (historical) measurement data can be accessed.

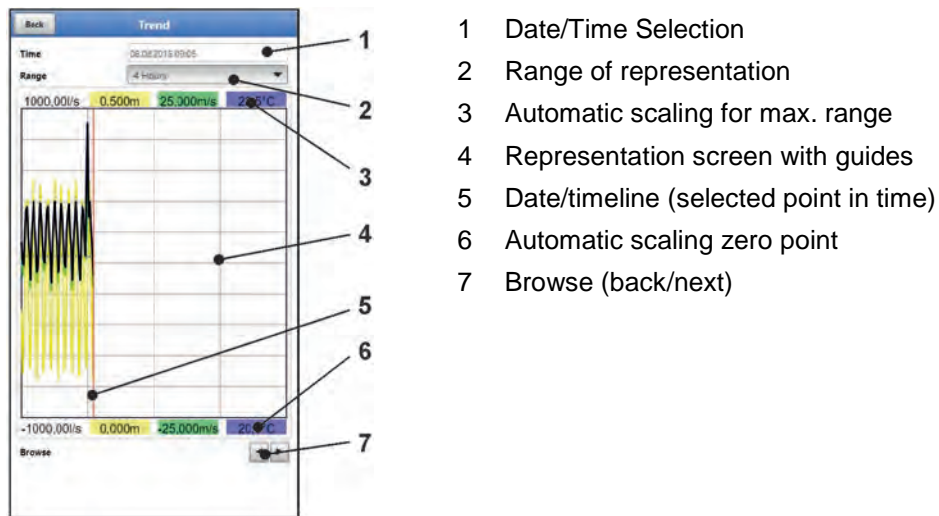

Fig. 40-2 Representation Trend Graph

Current Measurement Data

➡ Procedure for the representation of current readings:

1. Select the desired range (range of representation; Fig. 40-2 Pos. 2).
The selected range is displayed. There is no automatic update of measurement data during indication.
2. If necessary, use the arrows (Fig. 40-2 Pos. 7) to scroll forwards and backwards with the same basic display setting.
3. Back to the main screen via "Back".

>Date/Time Selection<

When the Trend menu is opened, the current date and time are displayed. If historical measurement data or a specific point in time is to be displayed, this can be set via the date/time selection (Fig. 40-2 Pos. 1). The selection mask shown below opens here (Fig. 40-3). If a start date is selected, (depending on the range set) the measurement data is shown in the display area below.



Fig. 40-3 Selection Date/Time

>Range (Period of representation)<

The selection of the range determines which period is to be displayed in the display area.

Selection	Representation in the Display Area		
	Left Margin	Right Margin	Guides
Hour	0 Minutes	59 Minutes	15 Minutes each
4 Hours	0/4/8/12/16/20 o'clock, depending on the set time	4 Hours later	1 Hour each
Day	0 o'clock	24 o'clock	4 Hours each
Week	Monday, 0 o'clock	Sunday, 24 o'clock	1 Day each
4 Weeks	Monday, 0 o'clock	4 Weeks later, Sunday, 24 o'clock	1 Week each, time reference point for the start: 29.12.1969, 0 o'clock

Tab. 8 Explanation of the periods displayed

40.2 Menu Day Totals

The table displayed here lists the flow total values of the last 24 hours in each case.

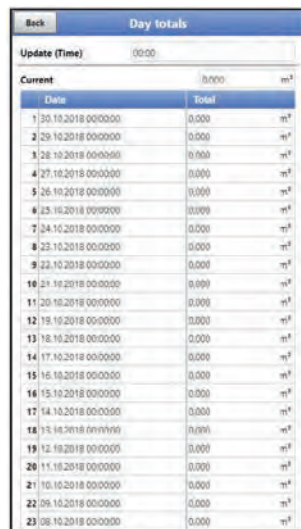

Date	Total	Unit
1 30.10.2018 00:00:00	0,000	m³
2 29.10.2018 00:00:00	0,000	m³
3 28.10.2018 00:00:00	0,000	m³
4 27.10.2018 00:00:00	0,000	m³
5 26.10.2018 00:00:00	0,000	m³
6 25.10.2018 00:00:00	0,000	m³
7 24.10.2018 00:00:00	0,000	m³
8 23.10.2018 00:00:00	0,000	m³
9 22.10.2018 00:00:00	0,000	m³
10 21.10.2018 00:00:00	0,000	m³
11 20.10.2018 00:00:00	0,000	m³
12 19.10.2018 00:00:00	0,000	m³
13 18.10.2018 00:00:00	0,000	m³
14 17.10.2018 00:00:00	0,000	m³
15 16.10.2018 00:00:00	0,000	m³
16 15.10.2018 00:00:00	0,000	m³
17 14.10.2018 00:00:00	0,000	m³
18 13.10.2018 00:00:00	0,000	m³
19 12.10.2018 00:00:00	0,000	m³
20 11.10.2018 00:00:00	0,000	m³
21 10.10.2018 00:00:00	0,000	m³
22 09.10.2018 00:00:00	0,000	m³
23 08.10.2018 00:00:00	0,000	m³

Fig. 40-4 Selection Day Totals

Up to 100 total values (= 100 days on which a value was recorded) are stored. From the value 101, the oldest value is overwritten (ring memory).

A **prerequisite** for the display of older values is that the device is also running for a longer period of time.

Example: 98 values - the device is running for 98 days

Generally, only the daily values can be read on which the transmitter was actually in operation.

If the transmitter is switched off between two totalising events (< 24 hours), the transmitter calculates a total from the **measured** values. This total does not correspond to the **actual** daily quantity that flowed, but to the quantity that the transmitter measured while it was switched on.

If the transmitter is switched off before the time of the next totalising and then remains switched off until the time of the next totalising (> 24 hours), the transmitter does not calculate a total for this period of time (Fig. 40-5 Pos. 2). No data is stored and the time period remains

unknown. This "gap" can be recognised by the fact that the relevant entry (date/values) is completely missing in the list sequence. **No blank lines** are shown.

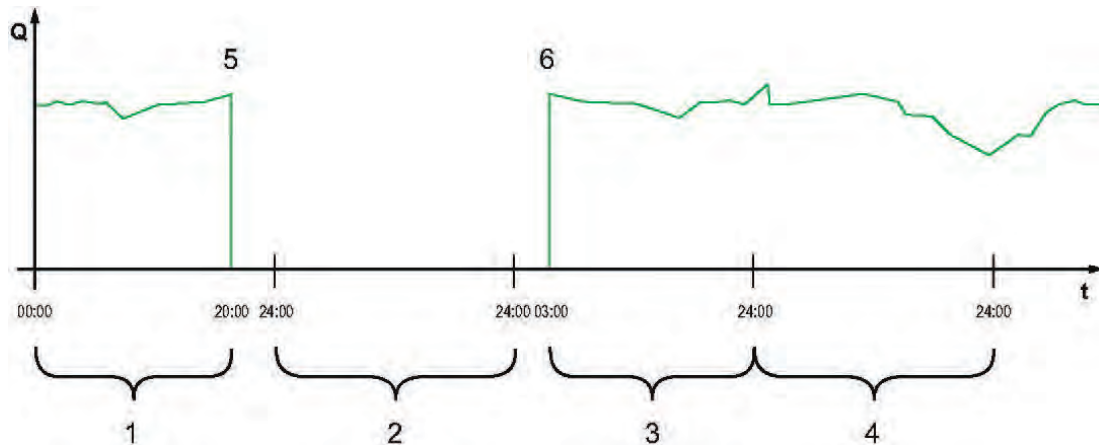

- 1 Total Day 1: total of 20 hours
- 2 Day 2: power failure - no totalising
- 3 Total Day 3: total of 21 hours
- 4 Total Day 4: total of 24 hours
- 5 Power failure
- 6 Power back again

Fig. 40-5 Scheme of Totalising

- The **time period** of the totalisation is between 00:00 o'clock and 24:00 o'clock **by default**. This means that the daily total is always computed between 00:00 and 24:00 o'clock.
- The **time** of the totalising is 00:00 o'clock **by default**.

The time of totalising can be modified in >Update (Time)< (Fig. 40-6). After a change of the time, the totalising starts at the set time and ends 24 hours later.



Fig. 40-6 Updating the totalising time

The value displayed at >Current< corresponds to the subtotal since the last totalising.

40.3 Menu Data Memory

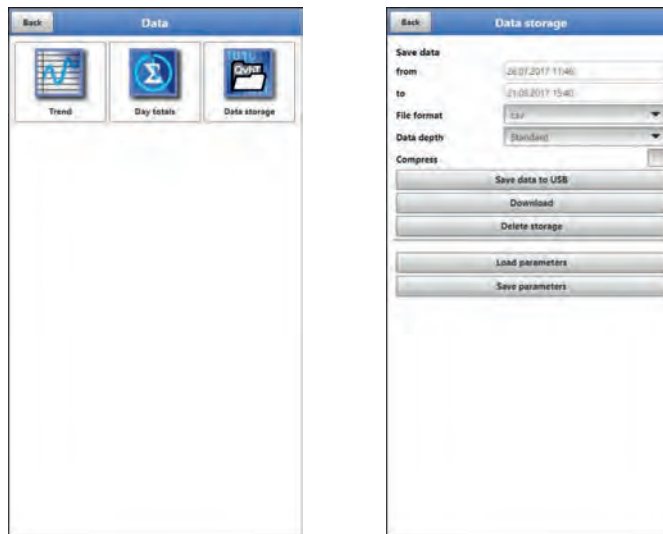

Fig. 40-7 Menu Data Memory

The transmitter has an internal data memory (max. 182,398 measuring cycles, after which it is overwritten). The data stored in it can be transferred partially or completely to a file or to a USB stick.

Conversely, files can also be (re)transferred to the data logger via the USB stick.



Use of the USB interface is only permitted outside the Ex area.

Requirements for the USB stick used

- Supports USB 2.0
- Formatted as FAT 32 (or FAT 12 or FAT 16)
- Maximum permissible memory size 32 GB

Procedure:

1. Open the enclosure cover and screw cover above the USB-A interface (see Fig. 2-4 on page 14).
2. Insert the corresponding USB stick into the USB-A interface.
3. Transmit data.
4. Remove the USB stick and close the screw cover and the enclosure cover.



Fig. 40-8 Set start/end time

- **>from< / >to<**
Sets the start and end time of the period from which the data to be transmitted originates. The selection is made in a kind of calendar (Fig. 40-8).
Per default, the transmitter offers the transmission period since the last data transmission up to the current time.
- **>File Format<**
>csv< or >txt<
- **>Data Depth<**
The data depth is divided into four areas. See also Tab. 9 on page 118.
The two data depths >Extended< and >Expert< are additionally bookable function licences and are only available after purchase and activation (see Chap. "19.2 Add-On Function Licences" and "41.5.5 Feature Unlock").
 - **>Standard<**
This memory format is sufficient for most applications and corresponds with the default setting.
The stored data records contain the following information:
 - Date and time
 - Totaliser
 - Calculated flow rate
 - Filling level - Average flow velocity
 - Water temperature
 - Current values as well as the values calculated from them for the activated analogue and digital inputs
 - Battery voltage - Current consumption of the NFM
 - **>Extended<**
This data set is useful for controlling critical and important applications and is mainly needed by service personnel.
The stored data sets contain the following information:
 - All data sets from the previous data depth >Standard<
 - Average flow velocities of the v-sensors 1, 2 and 3 (if used)
 - All individual gate velocities
 - Parameter values for the NIVUS-specific velocity evaluation method >COSP<
 - Trigger and hydraulic qualities of the v-sensors 1, 2 and 3 (if used)
 - **>Experte<**
Such data sets should only be activated by specially trained service personnel or developers of the NIVUS GmbH. These data sets can quickly become very large.
In addition to the data of the extended data set, the data sets also contain all

gate positions of all connected v-sensors.
If necessary contact NIVUS.

- **>Day Totals<**
With this setting, only the daily totals are saved, not individual values.
- **>Compress<**
This function is only useful for transmitting large amounts of data. In such a case, the selected files are zipped into the ".zip" format.
- **>Save Data on USB<**
With this function, the measurement values of the predefined period can be saved to a USB stick.
- **>Download<**
With this function, the measured values of the predefined period can be saved to a file on the operating device (smartphone, tablet, notebook, etc.). The memory format is ".csv".
- **>Delete Memory<**
The complete data of the internal data memory can be deleted here. After selecting, you will be asked whether you want to delete. After confirming with >Yes< the data is deleted, with >No< the process is cancelled.



Important Note

Deleted data cannot be restored!

- **>Load Parameters<**
With this function a previously saved parameter file can be loaded from the USB stick or the operating device to the transmitter.
- **>Save Parameters<**
Here the set parameterisation of the measurement place can be loaded onto the USB stick. Here two files are created and saved.
The files have the following formats:
 - **XXXX_DOC_AABBCCDDEE.pdf**
This file is for documentation purposes and contains basic settings and parameter changes made.
 - **XXXX_PAR_AABBCCDDEE.xml**
This file contains the complete parameter set of the transmitter. It is used to save the parameterisation that has been set.

Information on File Naming:

XXXX = Programmed name of the measurement place
 AO = Year
 BB = Month
 CC = Day
 DD = Hour
 EE = Minute

Information on the Data Depth Tables

Name	Data Depth	Meaning
Date	Standard, Extended, Expert	Date of the table entry (time of storage)

Time	Standard, Extended, Expert	Time of the table entry (time of storage)
app1_sum [m³]	Standard, Extended, Expert	Positive flow rate total at the time of storage
app1_q [l/s]	Standard, Extended, Expert	Flow volume at the time of storage, value calculated by the measurement system
app1_h [m]	Standard, Extended, Expert	Filling level at the time of storage, value used by the measurement system
app1_v [m/s]	Standard, Extended, Expert	Average velocity at the time of storage, value used by the measurement system
app1_t_water [°C]	Standard, Extended, Expert	Water temperature at the time of storage
app1_t_air [°C]	Standard, Extended, Expert	Air temperature on the air-ultrasonic sensor at the time of storage
app1_U_batt [V]	Standard, Extended, Expert	Supply Voltage
app1_I_batt [mA]	Standard, Extended, Expert	Current in measuring mode
ain1_val [m]	Standard, Extended, Expert	Measurement value analogue input 1
ain2_val [pH]	Standard, Extended, Expert	Measurement value analogue input 2
ain3_val [pH]	Standard, Extended, Expert	Measurement value analogue input 3
app1_h_air [m]	Extended, Expert	Level air-ultrasonic sensor at the time of storage
app1_h_pressure [m]	Extended, Expert	Level pressure sensor at the time of storage
app1_h_water [m]	Extended, Expert	Level water-ultrasonic sensor at the time of storage
app1_h_current [m]	Extended, Expert	Level 2-wire level sensor at the time of storage

ain1_curr [mA]	Extended, Expert	Current value present at analogue input 1
ain2_curr [mA]	Extended, Expert	Current value present at analogue input 2
ain3_curr [mA]	Extended, Expert	Current value present at analogue input 3
p<x>_v [m/s]	Extended, Expert	Average velocity of the sensor <x> (x is placeholder for the sensor number: p1, p2, p3 etc.)
p<x>_v<y> [m/s]	Extended, Expert	Measured flow velocity of sensor <x> in measurement window/gate <y> (y is placeholder for the gate number: v1, v2, v3 etc.)
p<x>_tq [%]	Extended, Expert	Trigger quality, presence of raw values from sensor <x> (depending on reflections)
p<x>_hq [%]	Extended, Expert	Hydraulic quality, measurements outside the histogram filter of sensor <x>
p<x>_ntyp [dBμ]	Extended, Expert	Typical noise in the sensor signal of sensor <x>
p<x>_nmax [dBμ]	Extended, Expert	Maximum noise in the sensor signal of sensor <x>
p<x>_pos<y> [m]	Expert	Position of the measurement window/gate in the vertical above the bottom <x> in measurement window/gate <y> (y is placeholder for the gate number: pos1, pos2, pos3 etc.)
diag_badlocks [-]	Expert	NIVUS-internal analysis channels
diag_mappedblocks [-]	Expert	NIVUS-internal analysis channels

Tab. 9 Information on the data (data depth)

41 Parameter Menu System

41.1 Menu Information



Fig. 41-1 Menu - System - Information

The menu >Information< is a display menu. It contains the following information on the device:

- Serial number and article number
- MAC Address
- Transmitter firmware version
- Specifications on the bootloader and the WLAN version
- Date of the last software update (firmware) and the last parameter storage
- Current charging status of the rechargeable battery blocks (when using two battery blocks, the one with the higher state of charge is first discharged to the same voltage level, then both are discharged simultaneously)
- Information on credits and licences

41.2 Menu Country Settings

In this menu you can make the following settings:

- (Operating) Language
- Date Format
- Units of the measurement values
Here it is possible to distinguish between displayed and stored measured values.

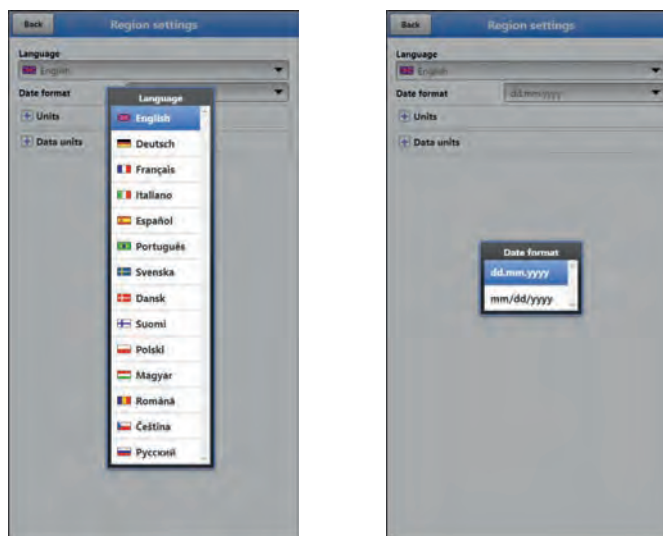

Fig. 41-2 Country Setting - Language - Date Format

41.2.1 (Operating) Language

All listed languages (Fig. 41-2) provide texts in the national language or the substitute language English.

41.2.2 Date Format

The following date formats can be set:

- DD.MM.YYYY (Day/Month/Year)
- MM/DD/YYYY (Month/Day/Year)

41.2.3 Units

At this point, various country-specific and unit system-dependent settings for the measurement values can be set.

>Decimal Separator<

- Comma or dot

The decimal separators entered here are only used for the display of the display and operating module.

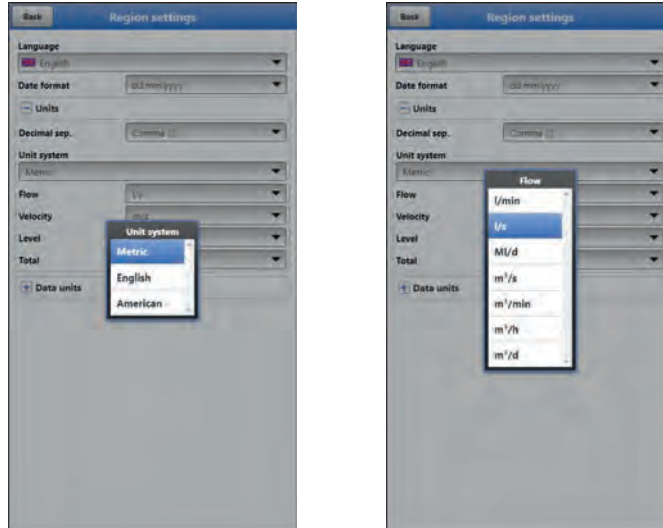

Fig. 41-3 Units system

>Units System<

The choices are:

- Metric
- English
- American

The **adjustable units** depend on the previous selection of the unit system:

- In the metric system: l, m³, cm/s etc.
- In the English system: ft, in, gal/s etc.
- In the American system: fps, mgd etc.

Units for the representation in the display for

- Flow
- Flow Velocity
- Level
- Total
- Temperature (only in unit system "English")

41.2.4 Data Units

The settings >Data Units< are analogous to the settings of the >Units<.

In >Data Units< the recorded measurement values are **converted and stored** according to the selected unit.

>Decimal Separator<

- Comma
- Dot

The specification of the decimal separators is important for the correct reading of the data. This is especially important when evaluating the measurement data with a software in a different language (e.g. English Excel), that the decimal separators are correctly selected.

>CSV Separator<

- Comma (,)
- Semicolon (;)

This selection determines how the individual data are separated in the .csv file when reading out the data.

>Units System<

The choices are:

- Metric
- English
- American

Units for the Storage

- In the metric system: l/s, m³/s, m³/d, cm/s etc.
- In the English system: ft³/s, in, gal/min, Mgal/d, in/s, yd/s etc.
- In the American system: gps, gpm, cfs, cfm, cfh, cfd, mgd etc.

Units for the Storage of Measurement Data for

- Flow
- Flow Velocity
- Level
- Total
- Temperature (only in unit system "English")

41.3 Menu Time/Date

In this submenu, the current date and the system time of the transmitter can be changed manually. The system time is based on the coordinated universal time UTC (en.: "Universal Time Coordinated"). The time zones are defined by "plus" or "minus" hours compared to UTC.

NIVUS strongly **recommends** keeping the system time of the transmitter and defining the respective time zone and also summer/winter times by the >Time Zone (UTC)<.

Via >**Sync Time/Date**<, the date and system time are automatically synchronised with the display and operating module.

Using the >Time/Date< menu may be necessary for the changeover from summer time to winter time, after a failure of the internal back-up battery or after a power failure.

If the transmitter is operated for a longer period of time, the internal clock may deviate. These deviations can be corrected here.



Effects of a System Time Change

Changing the system time affects the storage of the data. If data storage is activated, duplicate data or data gaps may occur after system time changes.

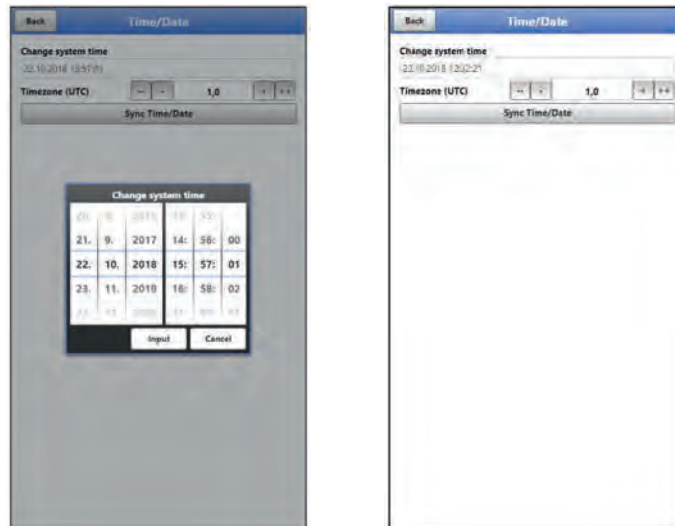

Fig. 41-4 Change system time: manually and automatically

The current system time is set via the selection menu (Fig. 41-4).

The time deviation (UTC or GMT) from the prime meridian is done via the "+" and "-" fields:

- = Decrease by 1 hour each
- = Decrease by ½ hour each
- + = Increase by ½ hour each
- ++ = Increase by 1 hour each

41.4 Menu Error Messages

In this menu, the current pending error messages can be called up and the error memory can be erased.

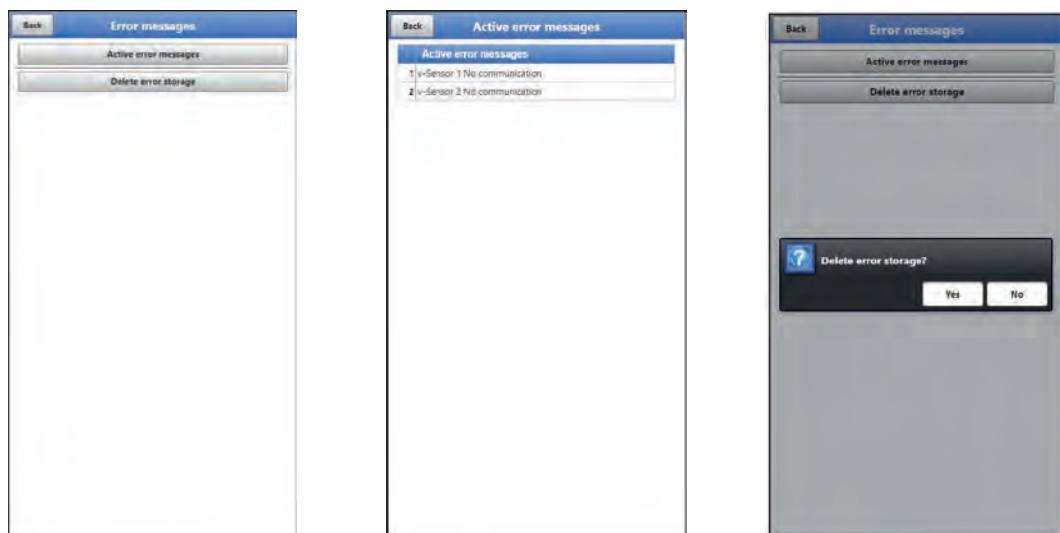

Fig. 41-5 Error messages

41.5 Menu Service

This submenu contains the following functions:

- Service levels (secured with passwords)
- Restart (of system)
- Powerdown (switching off the transmitter to energy-saving mode)

- Parameter reset (back to default settings)
- Feature Unlock
- Update NivuFlow Mobile 750
- Update Bootloader



Fig. 41-6 Service

41.5.1 Service Level

The service levels are divided into different access levels and protected accordingly with passwords.

These service levels are reserved exclusively for NIVUS service personnel. The settings possible there and the information stored require extensive specialist knowledge and are not required for the usual applications.

41.5.2 Restart

A restart of the transmitter interrupts the current measurement process.

The system boots using the set (saved) parameters. After booting, the system behaves as when it is switched on (analogous to the PC).

This menu point replaces switching the system off and on again. All saved parameters, counters and stored data are retained.

41.5.3 Powerdown

The >Powerdown< function switches the transmitter into an energy-saving mode. The unit will not resume its measuring function until it is "woken up".

41.5.4 Parameter Reset

During parameter reset, all parameters are reset to the default settings. Counter readings, changed passwords and stored measurement data are retained in the system.

The actual resetting of the parameters is only carried out after exiting the service menu (back to the main menu) and confirming the storage. The process can still be cancelled at this point.

41.5.5 Feature Unlock

Special (optionally available) functions can be enabled via the feature unlock, provided these have been ordered from NIVUS.

Info:

The following is an example of the procedure for activating the licence "FTP/SMTP Client" (NFM LIZENZ FTP). The procedure for all other optionally available functions is similar.

Function Description "FTP/SMTP Client"

The remote data transmission can be transmitted via different channels. Basically possible:

- Via MQTT to the NIVUS WebPortal or to a customer system
- Via FTP to the NIVUS D2W data portal to a customer FTP server
- Via e-mail to a pre-defined address



Fig. 41-7 Menu Communication

All NivuFlow Mobile devices are delivered in the basic version with the version for "MQTT Data Transmission". This variant is automatically activated and available immediately after the initial commissioning and corresponding parameterisation.

Data transfer via FTP and e-mail is additionally available via a combined licence and can either be ordered when placing the order or subsequently at any time.

The link to the NIVUS WebPortal (for the activation of this licence) will be sent by e-mail to the customer or the responsible country representative ^{*1} after dispatch of the ordered device or following the subsequent licence order. Manual activation is carried out by the user ^{*1} (see Chap. "Activation of the Licence"). As soon as the NivuFlow Mobile is parameterised accordingly, the data transmission variant can be selected and the data transmission started.



Parameter settings see Chap. "42 Parameter Menu Communication" (for the described example).

One licence is only valid for exactly **one device** and is permanently assigned to it through the **serial number**.

**1) Depending on the recipient country, the licence is activated by the responsible country representative even before the unit is shipped to the customer; all ordered features are then immediately available to the customer.*

Activation of the Licence

➡ Procedure for **ordering a device with a licence** using the example of "FTP / e-mail data transfer":

1. Place order for NivuFlow Mobile device with the respective licence(s) for remote data transmission.
Internally at NIVUS, processes are started which, on the one hand, concern the production of the NFM device and, on the other hand, initiate the licensing process.
2. After receiving the NFM device, log in to the NIVUS WebPortal and open the "Licences" tab. The access data was sent in advance by NIVUS via e-mail to an agreed e-mail address.



Assignment of the licence to the device unchangeable after being carried out

*One licence is only valid for exactly one device and is permanently assigned to it through the serial number. This assignment **cannot be changed** or **cannot be undone**.*

Before assigning, check exactly which device must/should be linked to which licence so that the correct device also receives the licence and can use this feature.

3. The existing NFM device(s) is/are listed in the NIVUS WebPortal. The ordered licences are displayed in the right-hand display field. These licences must be linked to the units via the serial numbers.
To do this, select the corresponding licence and click on "Activate". The selected licence disappears from the right-hand display field, but the associated licence number with the activation code is displayed on the unit. This activation code is subsequently required (once) for the parameterisation of the individual devices.
4. Proceed in the same way with other licences.
5. Log out from the NIVUS WebPortal and exit the application.

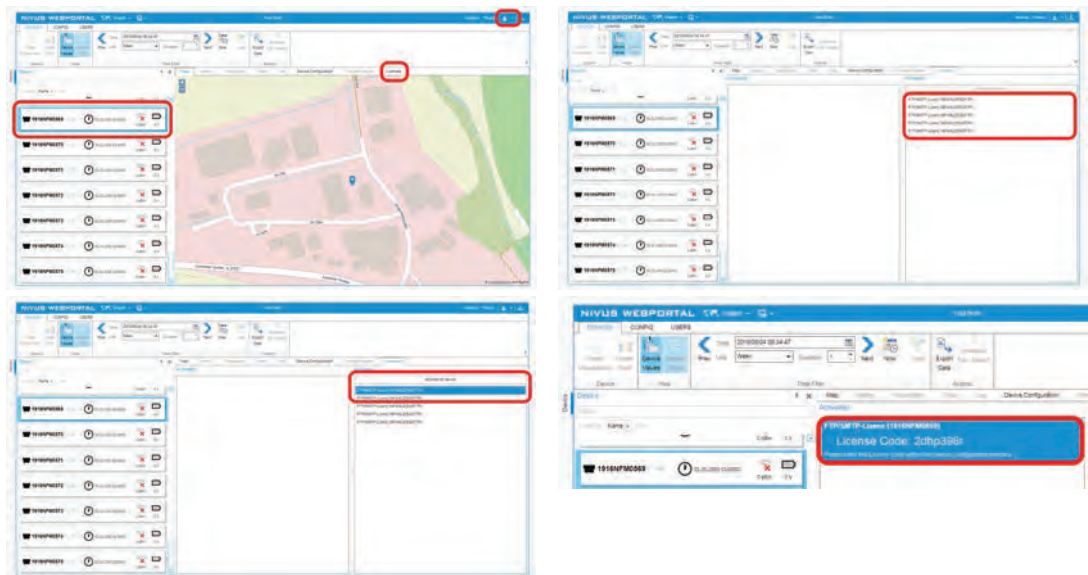

Fig. 41-8 Activation and licence in the WebPortal

6. Open the display and operating module (smartphone, tablet, notebook, PC etc.) for the respective NFM and select >Feature Unlock< (Fig. 41-9) in the Service menu (see the instruction manual of the device).
7. Click the >Feature Unlock< button.
8. Enter the corresponding activation code and confirm with Enter. The linked licence is shown in the display.



Fig. 41-9 Activation of the licence in the NFM display tool

9. The NFM confirms the activation and requests a device restart. In the menu Communication GPRS, the data transfer via FTP / e-mail option is now available.
10. Select/enter and save parameters in the >Communication< menu.

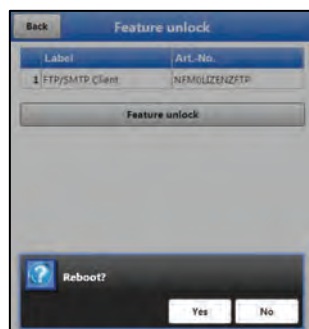

Fig. 41-10 System restart after feature unlock

➡ Procedure for **later ordering the licence** "FTP / e-mail Data Transmission":

1. Place order for the desired licence(s) for remote data transmission. Internally at NIVUS, processes are started which initiate the licensing process.
2. After receiving the access data, log in to the NIVUS WebPortal and open the "Licences" tab. The access data was sent by NIVUS via e-mail to an agreed e-mail address.
3. Proceed with step 3 from the description "Procedure for **ordering a device with a licence** using the example of the "FTP / e-mail Data Transmission". Please also note the important information on "Assignment of the licence to the device" on page 125.

41.5.6 Update NivuFlow Mobile 750

Upload of a NivuFlow Mobile firmware saved on USB.



Important Note

Update only in consultation with NIVUS GmbH or the responsible local (country) representation.

41.5.7 Update Bootloader

Upload of a bootloader software saved on USB.

Information on the bootloader/transmitter firmware version:

To update the bootloader to firmware version V2.00, at least firmware version V4.00 of the NivuFlow Mobile 750 transmitter must be available.

A firmware downdate of the bootloader is not permitted.



Important Note

Update only in consultation with NIVUS GmbH or the responsible local (country) representation.

41.6 Menu Storage Mode

In the >Storage Mode< menu, the >Operating Mode< and the >Storage Cycle< are set. Depending on the selected operating mode, the further settings described below are possible.

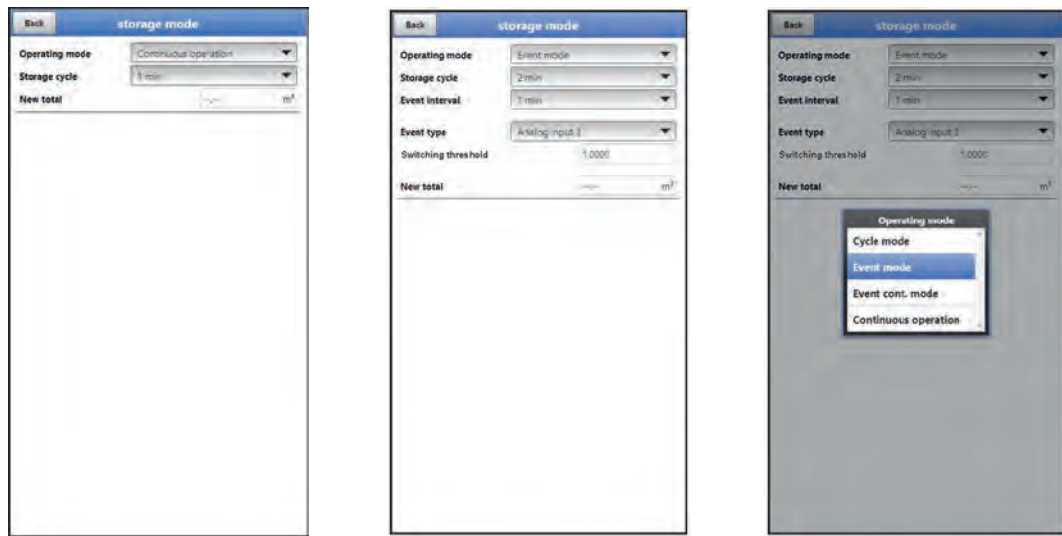

Fig. 41-11 Storage Mode – Operating Mode

Operating Mode, Storage Cycle and Event Interval

The selected operating mode determines when and how often the transmitter should take measurements and also save them. Depending on the operating mode, the storage cycle, the event interval and the event type can be set.

The choices for >Operating Mode< are

- >Cycle Mode<**

The transmitter wakes up at the intervals of the set storage cycle, measures for a short time and stores the determined measurement values. After that, the transmitter goes back into the "Sleep Phase" until the next measurement.
- >Event Mode<**

The event mode is an extended cycle mode. It has the same parameters and functionality as the cycle mode. In addition, it is possible to switch to the >Event Interval< by recognising that a definable measurand has been exceeded or undershot (see page 128). The measurand that triggers event operation is defined via the >Event Type< (see page 128).

In the event interval the transmitter measures cyclically. The event interval can contain much shorter measuring cycles than the cycle mode. This achieves a better measurement value resolution in important time ranges.

Example:

Measurement of the discharge volume in a discharge channel that is normally dry. Here it is sufficient for the transmitter to measure the value "0" in a storage cycle of 15 minutes and to spend the rest of the time in the sleep phase. If a discharge into the channel is then detected (e.g. using a float switch), the transmitter starts, triggered by the event that occurred, and measures in the set event interval/measurement cycle (e.g. 2 minutes). In the time between measurements, the transmitter goes back to sleep to save energy.

If an internal pressure measurement of a combi sensor is in use, it is checked in 1-

minute intervals, independent of the storage cycle, whether the level is above the defined switching threshold (with the event type level set) and then immediately switches to the event cycle.

For all other event types, except "Digital Input 1", the system always checks only at the specified storage cycle whether the defined switching threshold has been exceeded.

- **>Event Continuous Mode<**

The event continuous mode and its parameter settings are largely identical to the event mode.

In contrast, the transmitter does not switch off cyclically in the event interval during the event to save energy, but measures in continuous operation. The data is averaged over the entire time span of the event interval and stored in the cycle of the event interval.

The event continuous mode thus consumes slightly more energy than the event mode, but leads to more consistent measurement results for events with strongly fluctuating measured values (e.g. due to waves).

- **>Continuous Operation<**

The transmitter measures continuously, but stores the measured values only at the intervals of the set storage cycle. The permanently determined individual measured values are averaged internally. The average value of the measured values is saved.

>Storage Cycle<

Selection (depending on the operating mode set): (5 s, 10 s, 20 s, 30 s,) 1 min, 2 min, 5 min, 10 min, 30 min and 1 h

>Event Interval<

Setting options: 1 min, 2 min and 5 min

>Event Type< (only for Event Mode and Event Continuous Mode)

In the operating modes "Event Mode" and "Event Continuous Mode", depending on the parameters set the event types "Flow", "Level", "Water Temperature", "Air Temperature", "Analogue Input 1", "Analogue Input 2", "Analogue Input 3" and "Digital Input 1" can be also selected.

Except for "Digital Input 1", the **>Switching Threshold<** for the switchover can be defined in each case.

The displayed selection of event types varies depending on the parameterisation.

>New Total<

Here the flow rate can be reset to "0" or a new (base) value for the flow rate can be entered. For example, after a necessary replacement of the transmitter or when setting the parameters for a new measurement place.



Fig. 41-12 Event Types

42 Parameter Menu Communication

In this menu, communication is established with the display and operating module (smartphone, tablet, notebook, etc.) or other devices.

Communication is carried out via WLAN and GPRS.

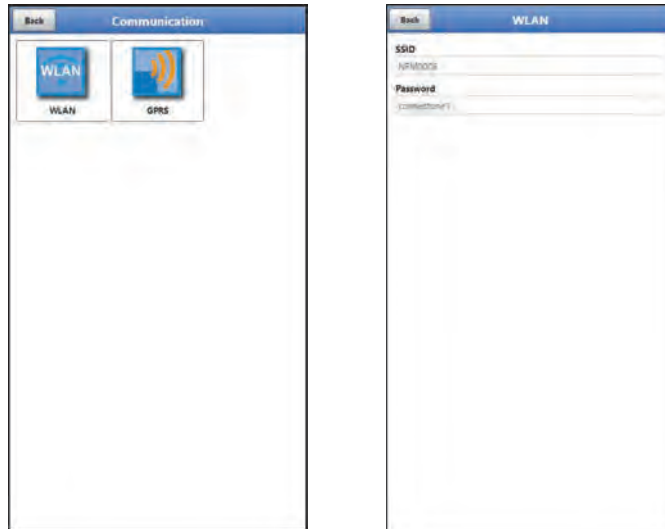

Fig. 42-1 Menu - Communication

Information on the SSID and the WLAN password is stored under **>WLAN<**. This menu is a display menu.

➡ To change the WLAN password see Chapter "36.2 Change WLAN Password".

Preparing the device for data transmission

The NivuFlow Mobile transmits data to the NIVUS WebPortal by using the **>Start Data Transmission<** button. The data can be selected/displayed there. In order for the respective measuring point to be displayed correctly on the overview map in the NIVUS WebPortal, i.e. with the correct GPS coordinates, their setting must be carried out correctly once at the beginning. There is no automatic update during measurement operation.

Prerequisite

The unit must be positioned so that it has a "clear view" up to the sky. So it is best to do this before placing it in the shaft or a room.

Procedure

1. Turn on the modem under **>Modem Status<**.
2. Wait until the device has searched for the GPS coordinates (latitude/longitude) and these have been entered in the menu (see Fig. 42-3). This may well take a few minutes.
Without these GPS coordinates, the measuring point will not be displayed correctly on the overview map in the NIVUS WebPortal, but the data will be assigned to the correct measurement place in any case.
3. Use the **>Start Data Transmission<** button to send data once to ensure that the connection is successfully established and the GPS coordinates are transmitted.
The NivuFlow Mobile can then be positioned in its planned installation location.

The remote data transmission is set up and parameterised under **>GPRS<**.

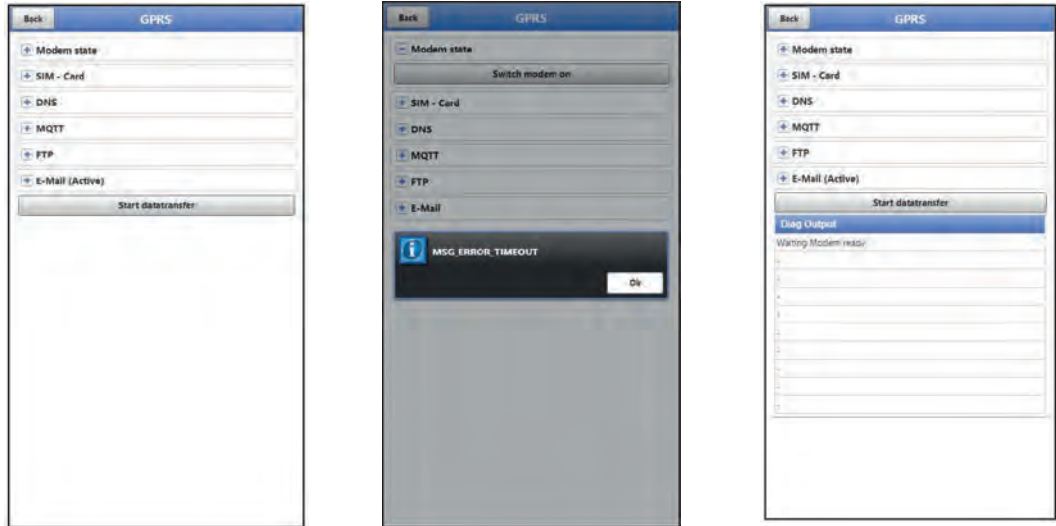

Fig. 42-2 Menu GPRS / Error Message Modem / Diag Output

After **inserting the SIM card**, the following submenus can be used correctly. Without a SIM card, the message "ERROR" or "MSG_ERROR_TIMEOUT" appears and a corresponding status message is displayed in the >Diag Output<.

- **>Modem State<**
 - **>Switch On Modem<**: Modem and SIM are initialised, the modem type, the version, the IMEI and the current status of the network is displayed (signal strength, network, frequency band, operator, latitude, longitude, altitude above sea level and number of satellites).
 - **>Set Up Test Connection<**: After successful switch-on, a test connection can be carried out. During the process, a current status info appears in the >Diag Output<.

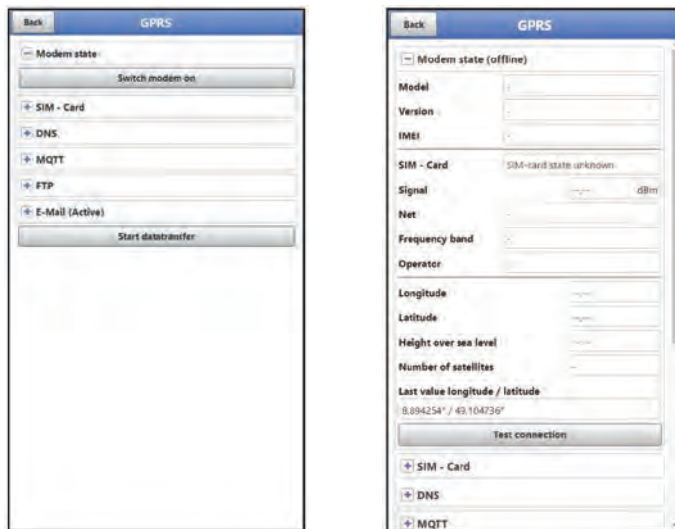

Fig. 42-3 Modem State

- **>SIM Card<**
 - **>Query Status<**: The status of the pin check is queried and displayed.
 - With the pin check activated, enter the corresponding PIN.
 - If the pin check is deactivated, the field can remain empty.
 - **>Activate PIN Check<**:
 - To activate, enter the PIN and select >Change PIN<.
 - To change the PIN with the pin check activated, enter the new PIN and then

select >Change PIN<.

- If the PIN was entered incorrectly 3 times, it must be entered via the PUK of the SIM card and a new PIN must be entered.

- **>Provider<**: Select the provider; available are NIVUS automatic mode (only in connection with NIVUS SIM cards), T-Mobile Germany, Vodafone Germany, O2, NIVUS, NIVUS Vodafone and User defined (for all customer SIM cards, except those mentioned above);
For User defined, enter the access data of the provider: APN (Access Point Name), possibly user name, possibly password, possibly IP address



Fig. 42-4 SIM Card

- **>DNS<**:
The names are usually assigned automatically (factory setting); if a specific DNS is required by the provider, enter it.



Fig. 42-5 DNS / MQTT

Factory setting for data transmission: Transmission to the NIVUS WebPortal (MQTT). You will receive the access data from NIVUS by e-mail.

If another transmission option (>FTP< or >E-mail<; available as an additional function licence *NFM0 LICENSE FTP* *1) is to be selected instead of this pre-set transmission, the MQTT transmission must be deactivated and then the alternative activated *1.

*1) See Chap. "19.2 Add-On Function Licences" and "41.5.5 Feature Unlock".

- **>MQTT<**

Transmission to the NIVUS WebPortal; alternatively, a direct connection to customer systems can be realised via the MQTT protocol, contact the NIVUS customer service for this.

- If the transmission is to be carried out via MQTT, activate the checkbox. The settings for transmission to the NIVUS WebPortal are already preconfigured.
- **>Broker<**: Enter the broker name.
- **>Port<**: Enter the MQTT port.
- Encryption via SSL can be selected optionally.
- **>Data<**: Selection of the data depth to be transmitted (Standard, Extended and Expert; partly only as additional function licence *NFMO LIZENZ ERW / NFMO LIZENZ EXP*) (see Chap. "40.3 Menu Data Memory").
- **>Time<**: Indication of the time of day at which a transmission is to be carried out.
- **>Cycle time<**: Setting of the transmission cycle in hours (1, 2, 3, 4, 6, 8, 12 or 24h).
- **>Check Settings<**: This can be used to check the settings, the result is output in **>Diag Output<**.
- **>Start data transmission<**: Data (error information, archive data and current values) are transmitted, the result is output in **>Diag Output<**.



Observe the procedure under "Preparing the device for data transmission" on page 129.

- **>FTP<**

Transmission to a customer FTP server or to the D2W data portal.

Available as additionally bookable function licence *NFMO LIZENZ FTP* (see Chap. "19.2 Add-On Function Licences" and "41.5.5 Feature Unlock").

- For transmission to a FTP server, activate the checkbox.
- **>Server<**: Specify server name or IP.
- **>Port<**: Enter FTP port (standard 21).
- Encryption via SSL can be selected optionally.
- **>Authentication<**: Activate with user and password-protected FTP access and specify in user name and password.
- **>Destination Folder<**: Enter the destination folder where the files are to be stored.
- **>Device to Web<**: Activate when transmitting to the D2W; the Device-to-Web compatible format is applied.
- **>File Format<**: There are csv and txt available.
- **>Data<**: Selection of the data depth to be transmitted (Standard, Extended and Expert; partly only as additional function licence *NFMO LIZENZ ERW / NFMO LIZENZ EXP*) (see Chap. "40.3 Menu Data Memory").
- **>Time<**: Specifies the time of the regular transmission; the time entered serves as the start time for the cyclic transmissions.
- **>Cycle Time<**: Setting of the transmission cycle in hours (1, 2, 3, 4, 6, 8, 12 or 24h)
- **>Check Settings<**: This can be used to check the settings, the result is output in **>Diag Output<**.

- **>Start data transmission<**: Data (error information, archive data and current values) are transmitted, the result is output in >Diag Output<.



Observe the procedure under "Preparing the device for data transmission" on page 129.

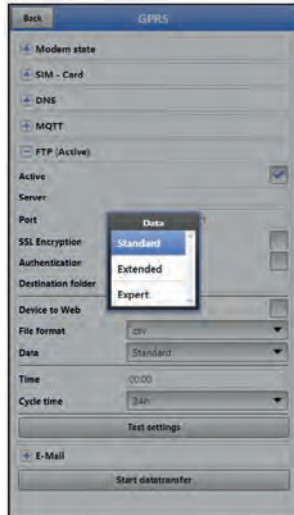

Fig. 42-6 FTP

- **>E-Mail<**
Transmission to an e-mail address.
Available as additionally bookable function licence *NFM0 LIZENZ FTP* (see Chap. "19.2 Add-On Function Licences" and "41.5.5 Feature Unlock").
You will receive the access data **>SMTP Server<**, **>User Name<** and **>Password<** from your e-mail provider.
 - For transmission to an e-mail address, activate the checkbox.
 - **>E-Mail Address<**:
 - **>From<**: E-mail sender address (needs to be accepted by the SMTP server)
 - **>To<**: Enter destination e-mail address
 - **>SMTP-Server<**: Enter e-mail server name (e.g. mail.gmx.net). Provider must support SMTP (Simple Mail Transfer Protokoll).
 - **>Port<**: Specify the port of the SMTP outgoing mail server.
 - **>SSL Encryption<** can be selected:
TLS, SSL or none.
 - **>User Name<**: Enter the user name of the e-mail box.
 - **>Password<**: Enter the password of the e-mail box.
 - **>Device to Web<**: Activate when transmitting to the D2W; the Device-to-Web compatible format is applied.
 - **>File Format<**: There are csv and txt available.
 - **>Data<**: Selection of the data depth to be transmitted (Standard, Extended and Expert; partly only as additional function licence *NFM0 LIZENZ ERW / NFM0 LIZENZ EXP*) (see Chap. "40.3 Menu Data Memory").
 - **>Time<**: Specifies the time of the regular transmission; the time entered serves as the start time for the cyclic transmissions.
 - **>Cycle time<**: Setting of the transmission cycle in hours (1, 2, 3, 4, 6, 8, 12 or 24h).
 - **>Check Settings<**: This can be used to check the settings, the result is output in >Diag Output<.

- **>Start data transmission<**: Data (error information, archive data and current values) are transmitted, the result is output in >Diag Output<.



Observe the procedure under "Preparing the device for data transmission" on page 129.

43 Parameter Menu Display

The display menu sets some attributes of the main display.
Can be modified:

- Name of the five display fields of the main display
- Decimal places of the individual values

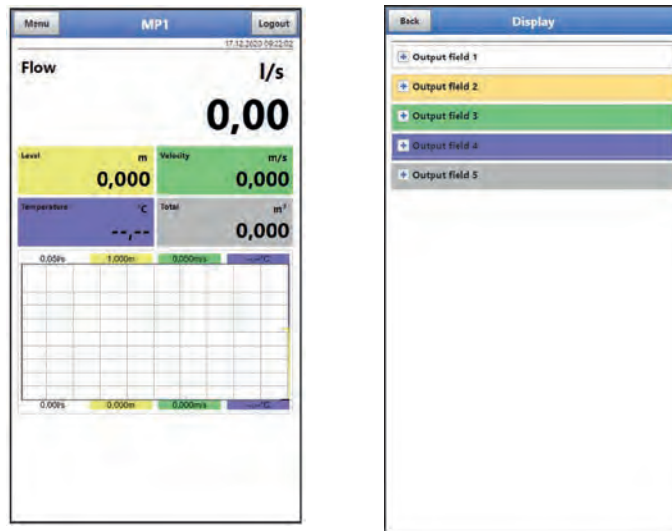

Fig. 43-1 Main display and output fields

Output Fields

The five output fields of the main display (Flow, Level, Velocity, Temperature and Total) can be freely defined in terms of designation and number of decimal places.



Assignment of the values to the output fields

The **assignment** of the values to the fields can **NOT** be changed.

*Example: The flow rate is **always** output in the flow field, even if you have changed the designation to "Temperature".*



Procedure to **change the name**:

1. Expand the output field.
2. Uncheck the >Default Label< box.
3. Enter a new name. This designation is freely selectable, but the number of characters is limited to 16.
The new name enter does **not** change the value of the fields in the main display.
4. Go "Back" several times to save the parameters.



To save see Chapter "36.1 Save Parameters".

➤ Procedure to **change the number of decimal places**:

1. Expand the output field.
2. Uncheck the >Standard Decimal Places< box.
3. Specify the new number of decimal places.
Any numbers can be entered, but only up to a maximum of five decimal places are accepted.
4. Go "Back" several times to save the parameters.



Setting the decimal places

When setting the decimal places, observe the measuring accuracies of the sensors and the set units of measurement.

The temperature sensor, for example, can only resolve in a 0.1 K grid.

44 Parameter Menu Battery (12V)

In this menu, the type of rechargeable/battery used and the corresponding number are selected.



Correct display of the capacity indicator

The capacity display in the >System< / >Information< menu only works reliably if fully charged battery blocks are used and the battery type and number of rechargeable battery blocks used are entered here.

At voltages <11.5 V (capacity 20 %), voltage dips and undervoltage shutdown may occur during remote data transmission.

NIVUS recommends replacing the rechargeable battery blocks at the latest when the remaining capacity is 20 %.

Tip:

By using two rechargeable batteries, storing and using them at non-critical temperatures (such as room temperature) and storing them dust-free, clean and dry, their capacity can be maintained for longer.

This means that even remote data transmission can often still function well at values below the threshold of 20 %.

The choices are:

- **1x NFM0 ZAPB 1215 (E)**
One NIVUS rechargeable battery block installed. The exact data on the rechargeable battery block are known and stored in the firmware.
Setting the number of NIVUS battery blocks enables the correct display of the rechargeable/battery power in the menu >System< / >Information<.
- **2x NFM0 ZAPB 1215 (E)**
Two NIVUS rechargeable battery blocks installed. The exact data on the rechargeable battery block are known and stored in the firmware.
Setting the number of NIVUS battery blocks enables the correct display of the rechargeable/battery power in the menu >System< / >Information<.
- **BATTERIE_MODE_USER**
The capacity [Ah] must be specified for the correct display of the rechargeable/battery power in the menu >System< / >Information<.

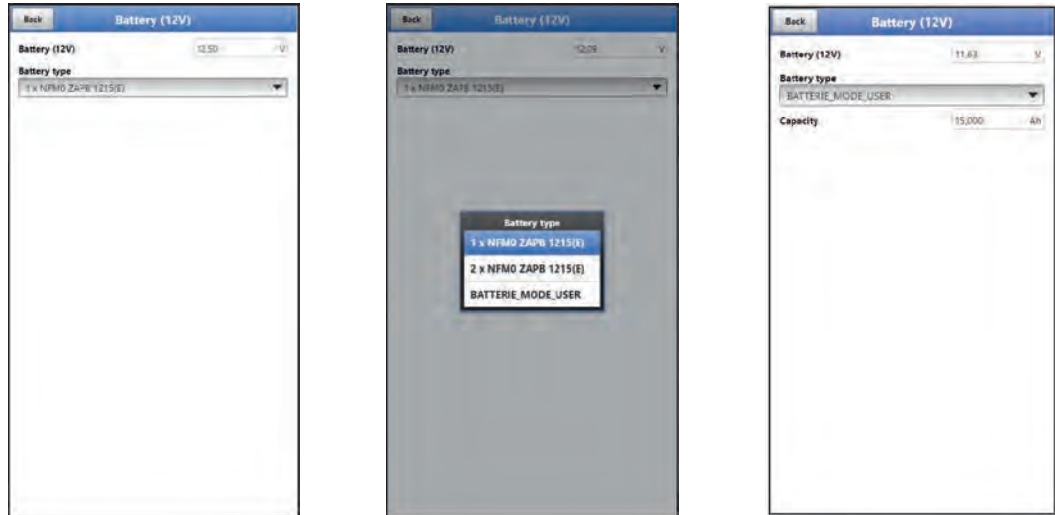

Fig. 44-1 Menu Battery (12V)

45 Parameter Menu Quick Start

The parameter menu >Quick Start< is divided in up to eleven pages (depending on the selection and the number of sensors). The pages >Country Settings< and >Measurement Place< are input pages and define the display of the measurement values and the measurement place itself. On the pages >h-Sensors<, >v-Sensor 1<, >v-Sensor 2< and >v-Sensor 3< the sensors can be selected and parameterised. The inputs are defined under >Analogue Input 1<, >Analogue Input 2<, >Analogue Input 3< and >Digital Input 1<. The last page >Communication< defines the communication/data transmission channels of the transmitter.



The procedure for setting the parameters is described in Chapter "37 Procedure for Setting Parameters via Quick Start".



Previously connected sensors facilitate parameterisation.

If the transmitter detects previously connected sensors during the sensor scan, the pages for the h/v sensors are already automatically parameterised/pre-set. Detailed individual parameterisation is then no longer necessary.

45.1 Menu >Quick Start< / >Country Settings<



Fig. 45-1 Country Settings

Under >Country Settings< the following parameters are set:

- (Operating) Language
- Date Format
- Units and data units
- System time and time zone
- Storage mode
 - Operation Mode
 - Storage Cycle
 - (Event Interval)
 - (Event Type)
- (Switching Threshold)

⇒ The individual settings are explained in greater detail in the Chapters "41.2 Menu Country Settings", "41.3 Menu Time/Date" and "41.6 Menu Storage Mode".

45.2 Menu >Quick Start< / >Measurement Place<

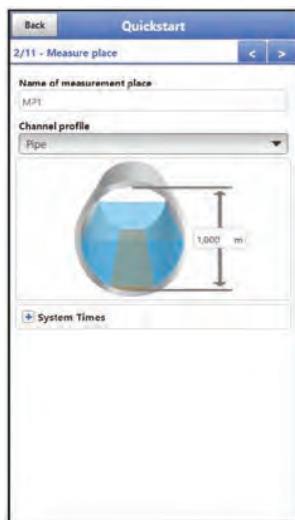

Fig. 45-2 Measurement Place

Under >Measurement Place< the following parameters are set:

- Name of the measurement place
- Channel Profile and Dimensions
- System Times

⇒ The individual settings are explained in greater detail in Chapter "39.1 Menu Measurement Place".

45.3 Menu >Quick Start< / >h-Sensors<



Fig. 45-3 h-Sensors

When selecting the page >h-Sensors<, the firmware checks the connected sensors and also enters their values directly as a preselection. These values, however, can be modified.

Under >h-Sensors< the following parameters can be set:

- Selecting the h-Sensor types
- Mounting Data



The individual settings are explained in greater detail in Chapter "39.2 Menu h-Sensors".

45.4 Menu >Quick Start< / >v-Sensor x<



Fig. 45-4 v-Sensor 1 / 2 / 3

Under >v-Sensor x< the following parameters are set:

- Selecting the v-Sensor types with the "Float" option
- Dimensions and data on sensor mounting
- Weighting
- Limit values for v-Determination low Levels

- Definition of v-Minimum/v-Maximum

If multiple sensors are used, they can be parameterised via the pages "5/11 v-Sensor 2" and "6/11 v-Sensor 3".

⇒ The individual settings are explained in greater detail in Chapter "39.3 Menu v-Sensors".

45.5 Menu >Quick Start< / >Analogue Input x<

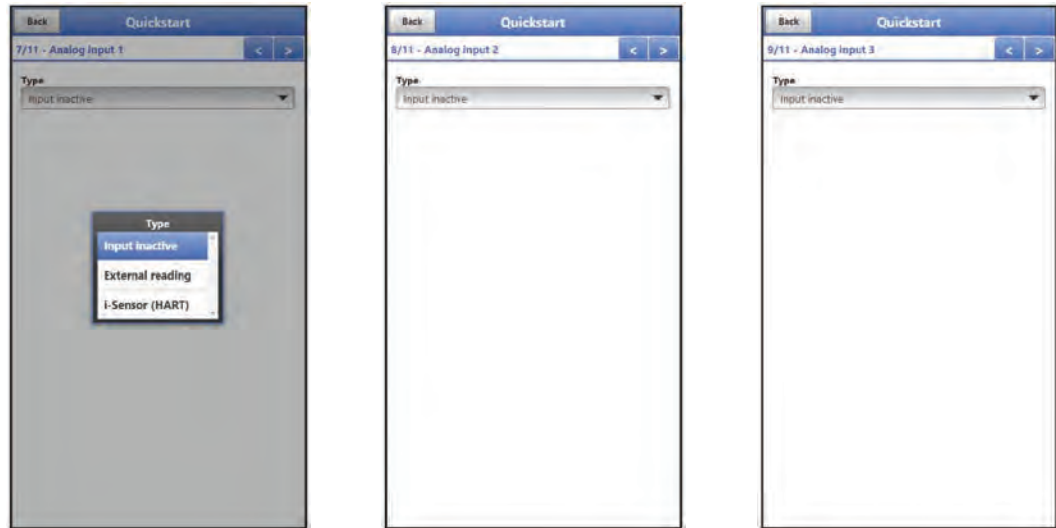

Fig. 45-5 Analogue Input 1 / 2 / 3

Under >Analogue Input 1<, >Analogue Input 2< and >Analogue Input 3< the according parameters are set for:

- External Measurement Value
- i-Sensor (HART) (only for Analogue Input 1)

⇒ The individual settings are explained in Chapter "39.4.1 Analogue Inputs".

45.6 Menu >Quick Start< / >Digital Input 1<



Fig. 45-6 Digital Input 1

Under >Digital Input 1< the according parameters are set for:

- Runtime
- Impulse Counter
- Logging

⇒ The individual settings are explained in Chapter "39.4.3 Digital Inputs".

45.7 Menu >Quick Start< / >Communication<



Fig. 45-7 Communication

Under >Communication< all parameters in the sector communication via GPRS are set.

⇒ The individual settings are explained in Chapter "42 Parameter Menu Communication".

46 Parameter Menu Alarm

The >Alarm< parameter menu is divided into up to ten sub-items. These sub-items are: >Flow<, >Level<, >Velocity<, >Water Temperature<, >Air Temperature<, >Battery (12V)<, >Analogue Input 1<, >Analogue Input 2<, >Analogue Input 3< and >Digital Input<.

All sub-items are only visible if the analogue and digital inputs have previously been assigned a type under >Application< and thus activated (see Chap. "39.4.1 Analogue Inputs" and "39.4.3 Digital Inputs").



For details beyond these operating instructions, on alarm management, alarm messages, alarm overview, status information etc. see also the NIVUS WebPortal manual.

46.1 Menu >Alarm< / >Flow<

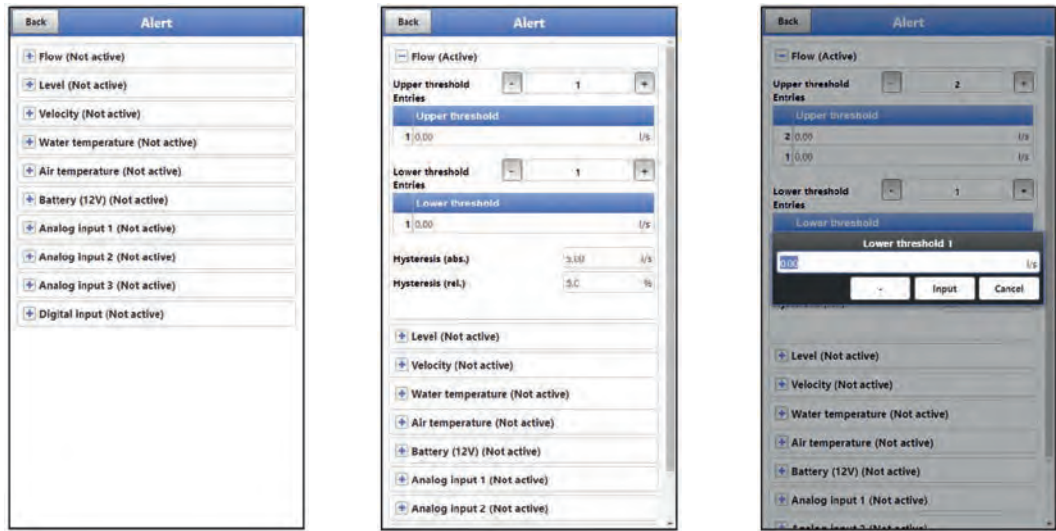

Fig. 46-1 Flow

For the >Flow< sub-item, up to five different threshold values can be entered using the "+" and "-" keys for **>Upper Thresholds Entries<** and for **>Lower Thresholds Entries<**. When these are reached, an alarm e-mail (only in connection with the NIVUS WebPortal) is to be issued.

The threshold values are defined by clicking on the fields and typing in numerical values. The transmitter sorts the entered threshold values in descending order. This is done independently of the input sequence.

For **>Hysteresis (abs.)<** and **>Hysteresis (rel.)<** values can be entered by clicking and typing. The transmitter evaluates the two values and sends an e-mail (only in connection with the NIVUS WebPortal) at the highest downwards limit (lowest possible value). This e-mail contains the information that the alarm has been cancelled.

Default Settings:

Hysteresis (abs.): values and units depend on the previously selected country settings

Hysteresis (rel.): 5.0 %



Alarm E-Mail for defective Flow Velocity Sensor

If an alarm e-mail is desired due to a defective flow velocity sensor, the check mark for >Alarm on Error< must be set under "46.4 Menu >Alarm< / >Water Temperature<".

Here with "Flow" this is not realised, as the transmitter does not distinguish between "invalid" and "Error" during detection.

46.2 Menu >Alarm< / >Level<

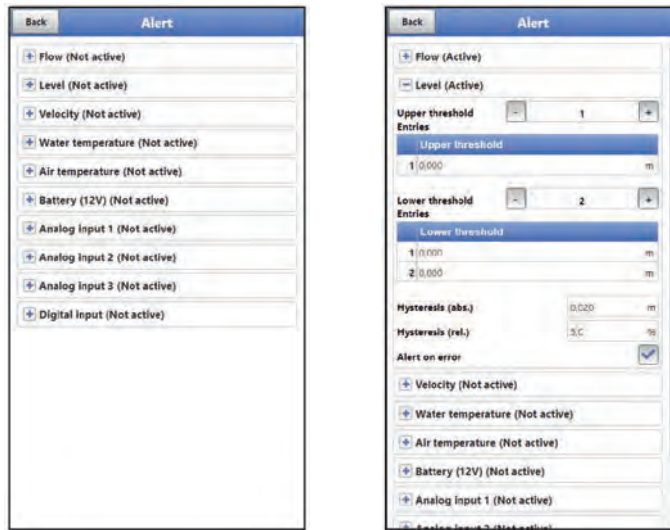

Fig. 46-2 Level

For the >Level< sub-item, up to five different threshold values can be entered using the "+" and "-" keys for >Upper Thresholds Entries< and for >Lower Thresholds Entries<. When these are reached, an alarm e-mail (only in connection with the NIVUS WebPortal) is to be issued.

The threshold values are defined by clicking on the fields and typing in numerical values. The transmitter sorts the entered threshold values in descending order. This is done independently of the input sequence.

For >Hysteresis (abs.)< and >Hysteresis (rel.)< values can be entered by clicking and typing. The transmitter evaluates the two values and sends an e-mail (only in connection with the NIVUS WebPortal) at the highest limit upwards (highest possible value) and at the lowest limit downwards (lowest possible value). This e-mail contains the information that the alarm has been cancelled.

Default Settings:

Hysteresis (abs.): values and units depend on the previously selected country settings
Hysteresis (rel.): 5.0 %

In addition, the checkbox >Alert on error< can be set. Then an alarm e-mail (only in connection with the NIVUS WebPortal) is sent in the event of an active pending error. Such errors are e.g. cable faults, interruptions, short circuits etc.

46.3 Menu >Alarm< / >Velocity<

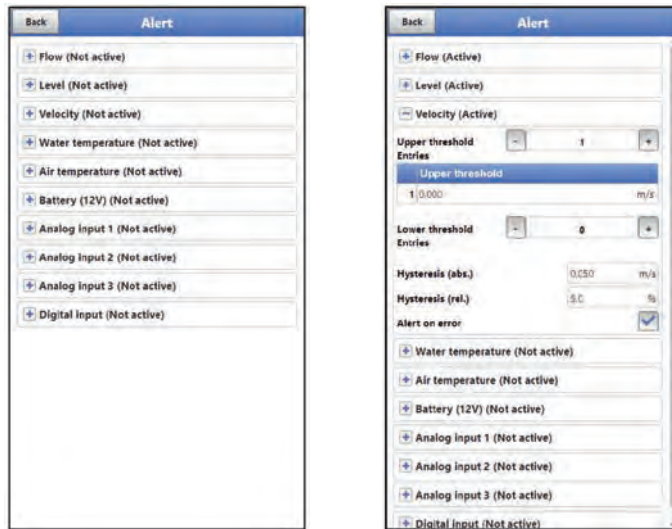

Fig. 46-3 Velocity

For the >Velocity< sub-item, up to five different threshold values can be entered using the "+" and "-" keys for >Upper Thresholds Entries< and for >Lower Thresholds Entries<. When these are reached, an alarm e-mail (only in connection with the NIVUS WebPortal) is to be issued.

The threshold values are defined by clicking on the fields and typing in numerical values. The transmitter sorts the entered threshold values in descending order. This is done independently of the input sequence.

For >Hysteresis (abs.)< and >Hysteresis (rel.)< values can be entered by clicking and typing. The transmitter evaluates the two values and sends an e-mail (only in connection with the NIVUS WebPortal) at the highest limit upwards (highest possible value) and at the lowest limit downwards (lowest possible value). This e-mail contains the information that the alarm has been cancelled.

Default Settings:

Hysteresis (abs.): values and units depend on the previously selected country settings
 Hysteresis (rel.): 5.0 %



Alarm E-Mail for defective Flow Velocity Sensor

If an alarm e-mail is desired due to a defective flow velocity sensor, the check mark for >Alarm on Error< must be set under "46.4 Menü >Alarm< / >Wassertemperatur<".

Here with "Velocity" this is not realised, as the transmitter does not distinguish between "invalid" and "Error" during detection.

46.4 Menu >Alarm< / >Water Temperature<

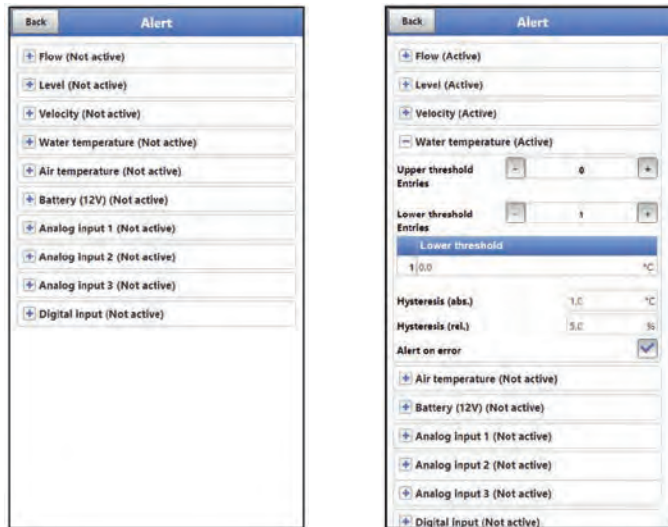

Fig. 46-4 Water Temperature

For the >Water Temperature< sub-item, up to five different threshold values can be entered using the "+" and "-" keys for >Upper Thresholds Entries< and for >Lower Thresholds Entries<. When these are reached, an alarm e-mail (only in connection with the NIVUS WebPortal) is to be issued.

The threshold values are defined by clicking on the fields and typing in numerical values. The transmitter sorts the entered threshold values in descending order. This is done independently of the input sequence.

For >Hysteresis (abs.)< and >Hysteresis (rel.)< values can be entered by clicking and typing. The transmitter evaluates the two values and sends an e-mail (only in connection with the NIVUS WebPortal) at the highest limit upwards (highest possible value) and at the lowest limit downwards (lowest possible value). This e-mail contains the information that the alarm has been cancelled.

Default Settings:

Hysteresis (abs.): values and units depend on the previously selected country settings
Hysteresis (rel.): 5.0 %

In addition, the checkbox >Alert on error< can be set. Then an alarm e-mail (only in connection with the NIVUS WebPortal) is sent in the event of an active pending error. Such errors are e.g. cable faults, interruptions, short circuits etc.

NIVUS recommend checking this box to receive an alarm e-mail if a flow velocity sensor is defective. A defect in the flow velocity sensor will cause the flow measurement to fail.

46.5 Menu >Alarm< / >Air Temperature<

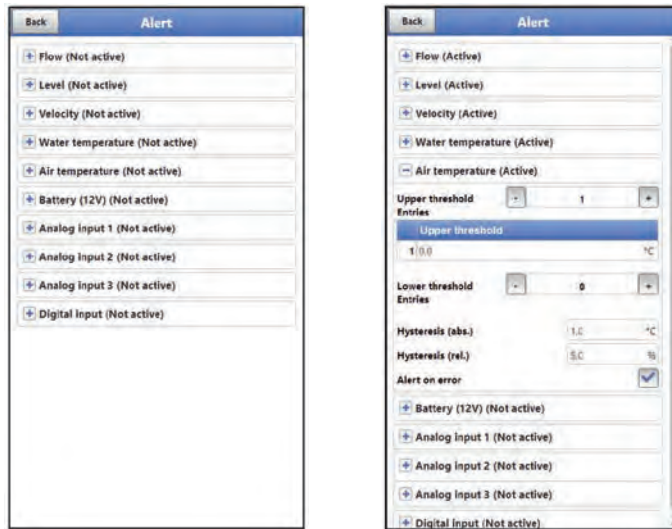

Fig. 46-5 Air Temperature

For the >Air Temperature< sub-item, up to five different threshold values can be entered using the "+" and "-" keys for >Upper Thresholds Entries< and for >Lower Thresholds Entries<. When these are reached, an alarm e-mail (only in connection with the NIVUS WebPortal) is to be issued.

The threshold values are defined by clicking on the fields and typing in numerical values. The transmitter sorts the entered threshold values in descending order. This is done independently of the input sequence.

For >Hysteresis (abs.)< and >Hysteresis (rel.)< values can be entered by clicking and typing. The transmitter evaluates the two values and sends an e-mail (only in connection with the NIVUS WebPortal) at the highest limit upwards (highest possible value) and at the lowest limit downwards (lowest possible value). This e-mail contains the information that the alarm has been cancelled.

Default Settings:

Hysteresis (abs.): values and units depend on the previously selected country settings
 Hysteresis (rel.): 5.0 %

In addition, the checkbox >Alert on error< can be set. Then an alarm e-mail (only in connection with the NIVUS WebPortal) is sent in the event of an active pending error. Such errors are e.g. cable faults, interruptions, short circuits etc.

46.6 Menu >Alarm< / >Battery (12V)<

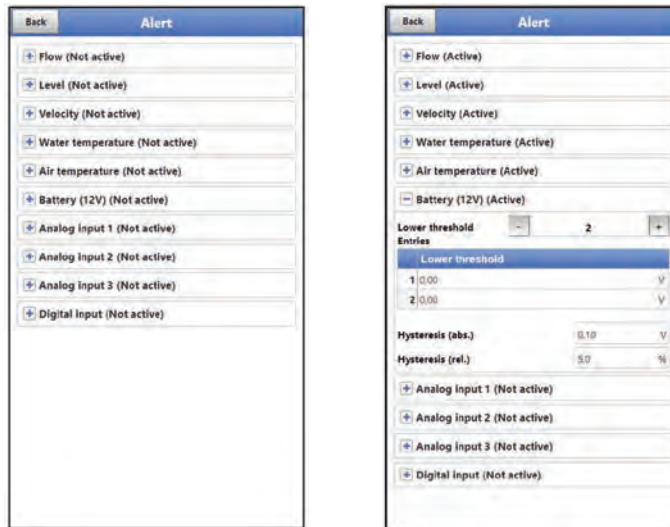

Fig. 46-6 Menu Battery (12V)

For the >Battery (12V)< sub-item, up to five different threshold values can be entered using the "+" and "-" keys for >Lower Thresholds Entries<. When these are reached, an alarm e-mail (only in connection with the NIVUS WebPortal) is to be issued.

The threshold values are defined by clicking on the fields and typing in numerical values. The transmitter sorts the entered threshold values in descending order. This is done independently of the input sequence.

For >Hysteresis (abs.)< and >Hysteresis (rel.)< values can be entered by clicking and typing. The transmitter evaluates the two values and sends an e-mail (only in connection with the NIVUS WebPortal) at the highest limit upwards (highest possible value) and at the lowest limit downwards (lowest possible value). This e-mail contains the information that the alarm has been cancelled.

Default Settings:

Hysteresis (abs.): 0.10 V

Hysteresis (rel.): 5.0 %

46.7 Menu >Alarm< / >Analogue Input 1<

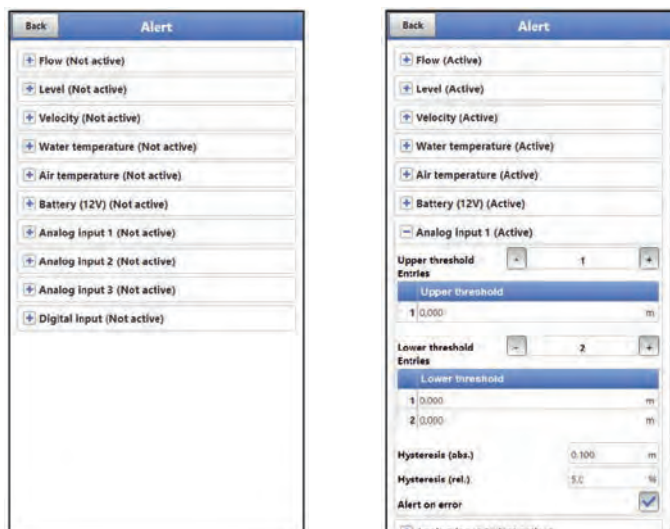

Fig. 46-7 Analogue Input 1

For the >Analogue Input 1< sub-item, up to five different threshold values can be entered using the "+" and "-" keys for >Upper Thresholds Entries< and for >Lower Thresholds

Entries<. When these are reached, an alarm e-mail (only in connection with the NIVUS WebPortal) is to be issued.

The threshold values are defined by clicking on the fields and typing in numerical values. The transmitter sorts the entered threshold values in descending order. This is done independently of the input sequence.

For **>Hysteresis (abs.)<** and **>Hysteresis (rel.)<** values can be entered by clicking and typing. The transmitter evaluates the two values and sends an e-mail (only in connection with the NIVUS WebPortal) at the highest limit upwards (highest possible value) and at the lowest limit downwards (lowest possible value). This e-mail contains the information that the alarm has been cancelled.

Default Settings:

Hysteresis (abs.): depending on the analogue input parameter settings

Hysteresis (rel.): depending on the analogue input parameter settings

In addition, the checkbox **>Alert on error<** can be set. Then an alarm e-mail (only in connection with the NIVUS WebPortal) is sent in the event of an active pending error. Such errors are e.g. cable faults, interruptions, short circuits etc.

46.8 Menu >Alarm< / >Analogue Input 2<

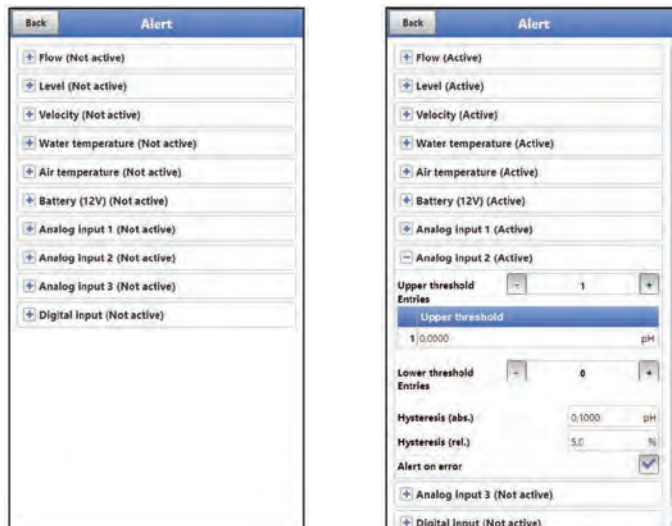

Fig. 46-8 Analogue Input 2

For the **>Analogue Input 2<** sub-item, up to five different threshold values can be entered using the "+" and "-" keys for **>Upper Thresholds Entries<** and for **>Lower Thresholds Entries<**. When these are reached, an alarm e-mail (only in connection with the NIVUS WebPortal) is to be issued.

The threshold values are defined by clicking on the fields and typing in numerical values. The transmitter sorts the entered threshold values in descending order. This is done independently of the input sequence.

For **>Hysteresis (abs.)<** and **>Hysteresis (rel.)<** values can be entered by clicking and typing. The transmitter evaluates the two values and sends an e-mail (only in connection with the NIVUS WebPortal) at the highest limit upwards (highest possible value) and at the lowest limit downwards (lowest possible value). This e-mail contains the information that the alarm has been cancelled.

Default Settings:

Hysteresis (abs.): any setting selectable by manual input of the analogue input parameter settings

Hysteresis (rel.): 5.0 %

In addition, the checkbox **>Alert on error<** can be set. Then an alarm e-mail (only in connection with the NIVUS WebPortal) is sent in the event of an active pending error. Such errors are e.g. cable faults, interruptions, short circuits etc.

46.9 Menu **>Alarm<** / **>Analogue Input 3<**

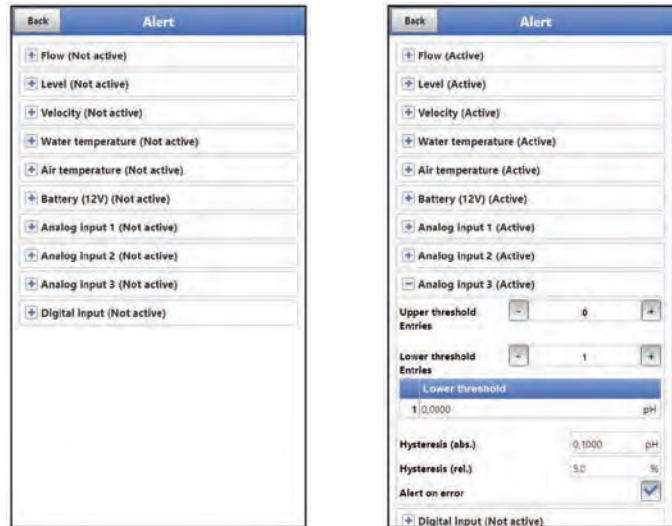

Fig. 46-9 Analogue Input 3

For the **>Analogue Input 3<** sub-item, up to five different threshold values can be entered using the "+" and "-" keys for **>Upper Thresholds Entries<** and for **>Lower Thresholds Entries<**. When these are reached, an alarm e-mail (only in connection with the NIVUS WebPortal) is to be issued.

The threshold values are defined by clicking on the fields and typing in numerical values. The transmitter sorts the entered threshold values in descending order. This is done independently of the input sequence.

For **>Hysteresis (abs.)<** and **>Hysteresis (rel.)<** values can be entered by clicking and typing. The transmitter evaluates the two values and sends an e-mail (only in connection with the NIVUS WebPortal) at the highest limit upwards (highest possible value) and at the lowest limit downwards (lowest possible value). This e-mail contains the information that the alarm has been cancelled.

Default Settings:

Hysteresis (abs.): any setting selectable by manual input of the analogue input parameter settings

Hysteresis (rel.): 5.0 %

In addition, the checkbox **>Alert on error<** can be set. Then an alarm e-mail (only in connection with the NIVUS WebPortal) is sent in the event of an active pending error. Such errors are e.g. cable faults, interruptions, short circuits etc.

46.10 Menu >Alarm< / >Digital Input<

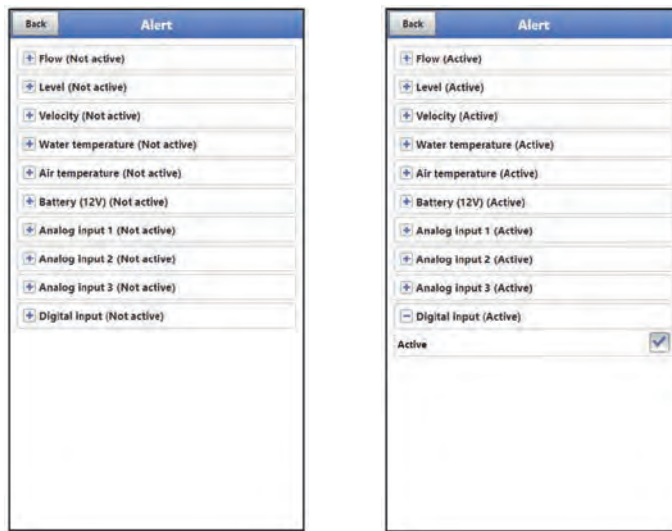

Fig. 46-10 Digital Input

In the sub-item >Digital Input< a check mark can be set to activate an alarm e-mail (only in connection with the NIVUS WebPortal) when a digital "high" occurs at the digital input.

Default setting: box unchecked

Diagnostics

47 Basics of the Diagnostics Menu



Fig. 47-1 Menu Diagnostics

The menu >Diagnostics< can be found in the >Application< menu. Diagnostics is divided into six submenus.

The Diagnostics menu and all submenus are purely display and simulation menus.

In this section, settings for the following areas can be displayed or simulated:

- h-Sensors
- v-Sensors
- Inputs/Outputs
- Flow profile
- Signal analysis
- Simulation



Follow the safety instructions for the simulation

It is essential to follow the safety instructions for the simulation on page 153.

48 Menu Diagnostics h-Sensors

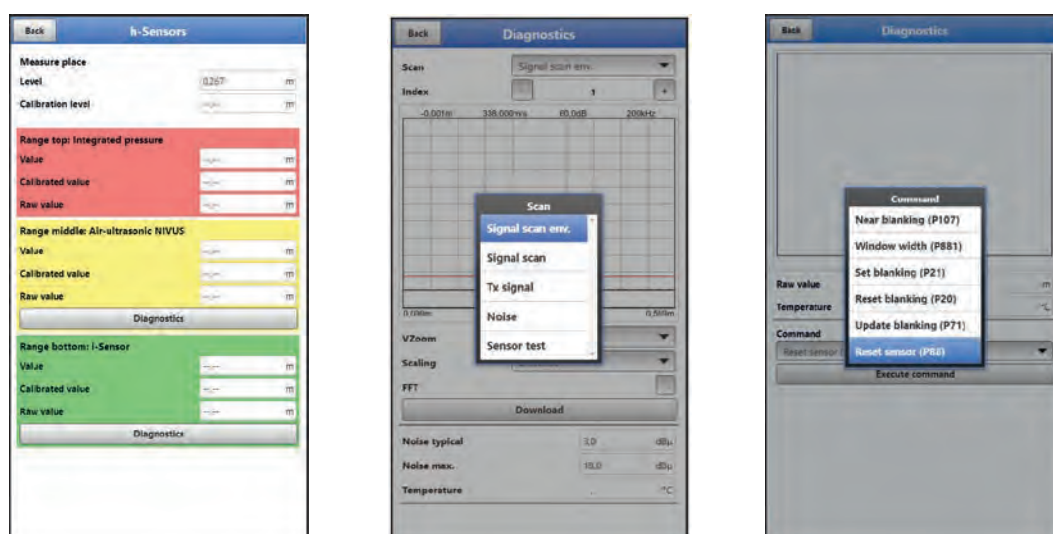

Fig. 48-1 Menu Diagnostics h-Sensors

This menu works in conjunction with the >Applications< / >h-Sensors< menu. Depending on the type and number of sensors defined there, the areas are displayed in colour.

➡ See Chapter "39.2 Menu h-Sensors".

The current fill level is displayed in the diagnosis. The adjustment height can be set and is also confirmed with OK after entry. The adjustment height corresponds to the offset and is usually specified when the h-sensors parameters are set.

Depending on which sensors are selected, the value, the calibrated value or the raw value is displayed.

- Value: output value
- Calibrated Value: corrected, used value
- Raw value: value actually measured

The following parameters can be used to adjust the graphic in the display:

- >VZoom< of graphic: X1, X2, X5, X10, X20 and X50
- >Scaling< of graphic: time or distance
- >FFT<: to display the frequency spectrum; if the checkmark is set, the selection for scaling the graph is omitted.

With >Download< the data of the graphic can be downloaded.

In addition, information on "Signal Scan Envelope", "Signal Scan", "Transmit Signal", "Noise" and "Sensor Test" can be displayed (depending on the connected/selected sensor type).

Various commands such as "Near Blanking", "Window Width", "Set Blanking", "Reset Blanking", "Update Blanking" and "Reset Sensor" can be also executed in this menu.

49 Menu Diagnostics v-Sensors

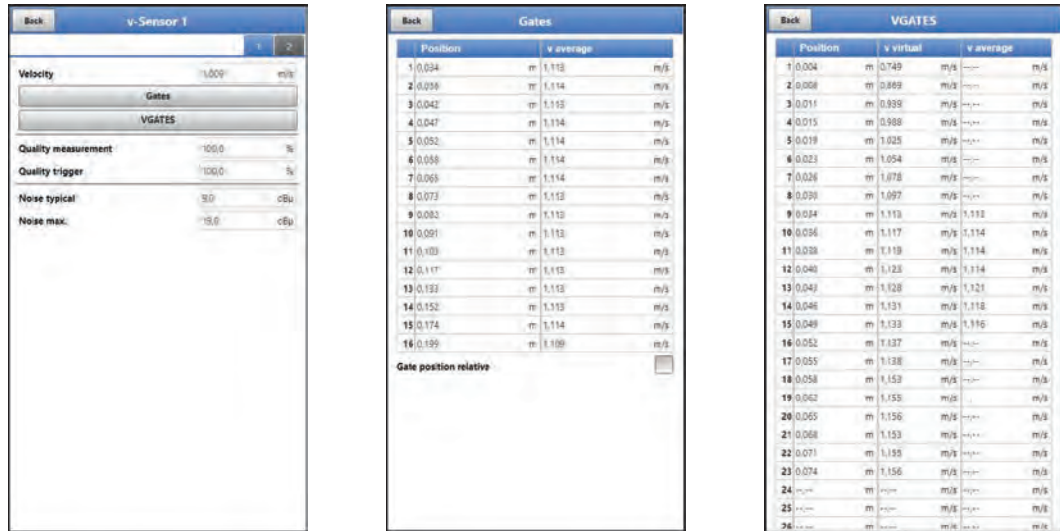

Fig. 49-1 Menu Diagnostics v-Sensors

This menu is only needed for analysis purposes.

In case of disturbances or uncertainties in the cross-correlation measurement, various factors can be used to determine the cause.

Displayed:

- **>Velocity<**
Display of the current flow velocity (calculated from the different gates).
- **>Gates<**
Display of the average flow velocity of the individual gates (for calculating the velocity).
- **>VGATES<**
Display of the virtual and average individual flow velocities and their positions.
- **>Measurement Quality<**
Relevant for NIVUS commissioning and service personnel.
- **>Trigger Quality<**
Relevant for NIVUS commissioning and service personnel.
- **>Noise typical<**
Information about the installation of the sensor cable (interference); relevant for NIVUS commissioning and service personnel.
- **>Noise maximum<**
Information about the installation of the sensor cable (interference); relevant for NIVUS commissioning and service personnel.

50 Menu Diagnostics Inputs/Outputs

50.1 Important Information on Simulation

DANGER



Injuries and damage due to improper simulation

The simulation has an effect on downstream plant components. Disregarding may result in personal injury and damage to the system.

This may only be carried out by qualified electricians who have precise knowledge of the entire regulation and control process of the system.

Prepare the simulation in detail!

- *Switch the downstream equipment to manual operation.*
- *Switch off the actuators etc. or limit their function.*

A safety person is absolutely necessary during the performance!

DANGER



Effect on Plant Sections

A simulation of the NivuFlow Mobile outputs directly accesses all downstream plant sections without any safety interlock.

Observe the regulations of the warning notice mentioned above!



Important Note

Due to the extremely high risk potential and the incalculable consequences of inadequate or incorrect simulation or disregard of the safety instructions, NIVUS hereby decline any responsibility whatsoever for any personal injury or damage to property in any amount!

This menu is divided into analogue inputs, analogue outputs, digital inputs and digital outputs.

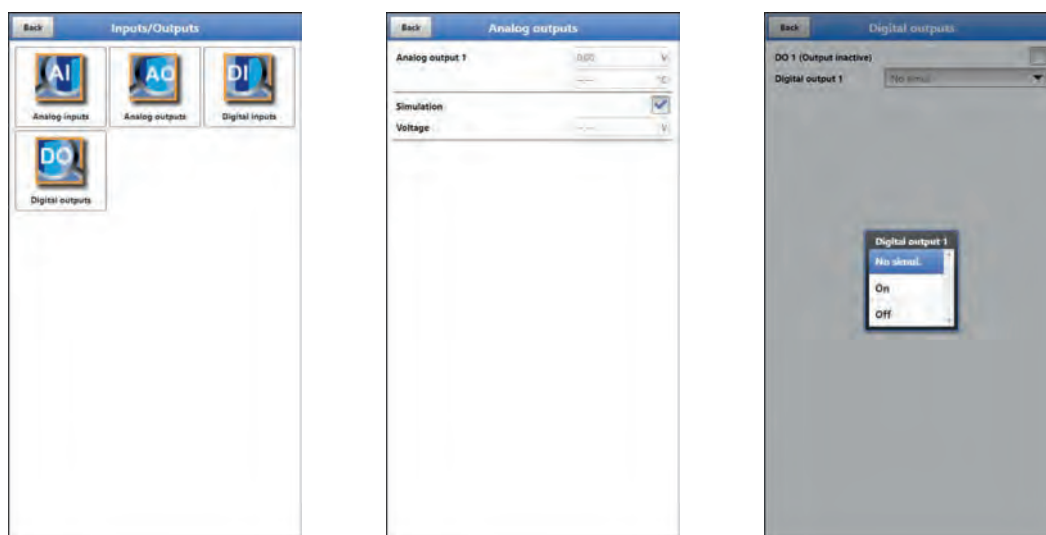

Fig. 50-1 Menu Input/Outputs

- **>Analogue Inputs<**
The current values present at the respective analogue inputs are displayed.
- **>Analogue Outputs<**
The applied voltage values and the determined medium temperature are displayed. By setting the checkmark for the simulation, a present voltage can be simulated (Fig. 50-1).
Be sure to observe the preceding safety instructions for simulation and possible hazards (consequences for the downstream system) on page 153!

- **>Digital Inputs<**
The menu shows present signals at the digital input with the appearance/absence of the tick.
- **>Digital Outputs<**
Active digital outputs are identified with a tick.



Actually switched Relay

The status of the actually switched relay cannot be displayed. Only the signal that the relay receives for output is visible.

An external faulty circuit cannot be detected and displayed in this menu.

A simulation of the digital output can be determined by selecting: >No Simulation<, >On< or >Off< (Fig. 50-1).

Be sure to observe the preceding safety instructions for simulation and possible hazards (consequences for the downstream system) on page 153!

51 Menu Diagnostics Flow Profile

The graphic flow profile in the diagnostics is a mere display.
The following views of the flow profile can be selected:

- Perspective
- Top
- Front
- Side

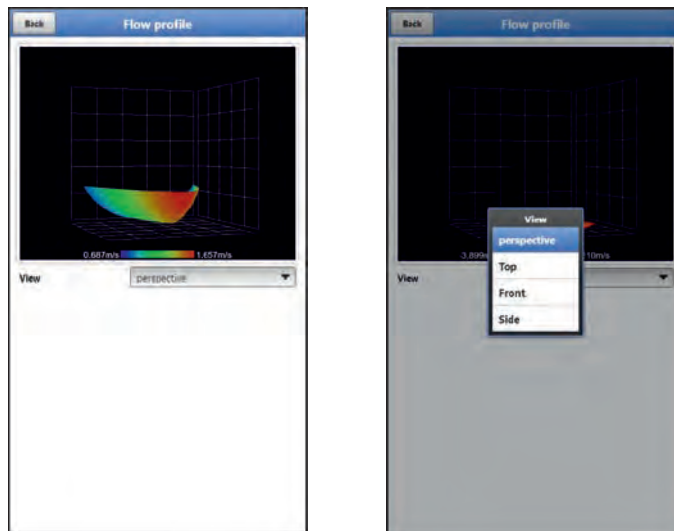

Fig. 51-1 Menu Diagnostics Flow Profile

The graphic flow profile is calculated according to internal hydraulic methods.
The following factors are included in the calculation of the flow profile:

- Individual velocities
- Individual heights
- Channel profile
- Channel dimensions

The use of multiple flow velocity sensors improves the quality of this representation. Horizontal hydraulic disturbances also become visible this way.

52 Menu Diagnostics Signal Analysis

In this menu, the pending sensor signal is searched for and evaluated. In addition, the functionality of the sensor can be tested.

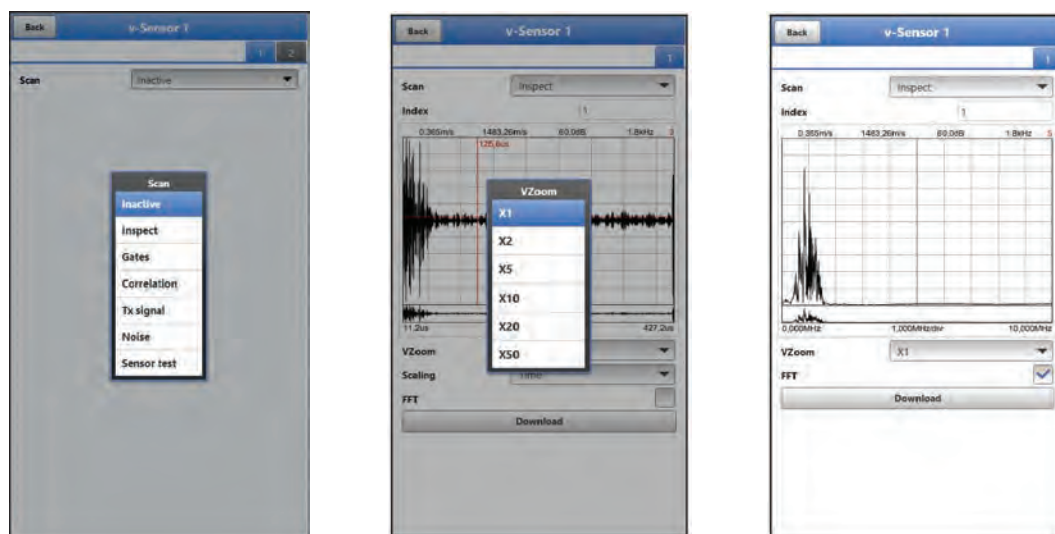

Fig. 52-1 Signal Analysis Selection Menu / Inspect / Inspect FFT

In detail, the following options are available:

- **>Inactive<**
No signal search/evaluation.
- **>Inspect<**
(Rough) search for the signal based on the client's settings and possibly a range extension. The red number at the top right of the graphic stands for the respective signal displayed for the sub-areas (these are displayed alternately on a continuous basis).
 - >Index<: sub-areas 1...8
 - >VZoom< of graphic: X1, X2, X5, X10, X20 and X50
 - >Scaling< of graphic: time or distance
 - >FFT<: to display the frequency spectrum; if the checkmark is set, the selection for scaling the graph is omitted.
 - >Download<
- **>Gates<**
More detailed representation of the signals of the 16 gates from the somewhat rougher representation with >Inspect<. The red number at the top right of the graphic stands for the respective signal displayed for the gates (these are displayed alternately on a continuous basis).
 - >Index<: Gates 1...16
 - >VZoom< of graphic: X1, X2, X5, X10, X20 and X50
 - >Scaling< of graphic: time or distance
 - >FFT<: to display the frequency spectrum; if the checkmark is set, the selection for scaling the graph is omitted.
 - >Download<

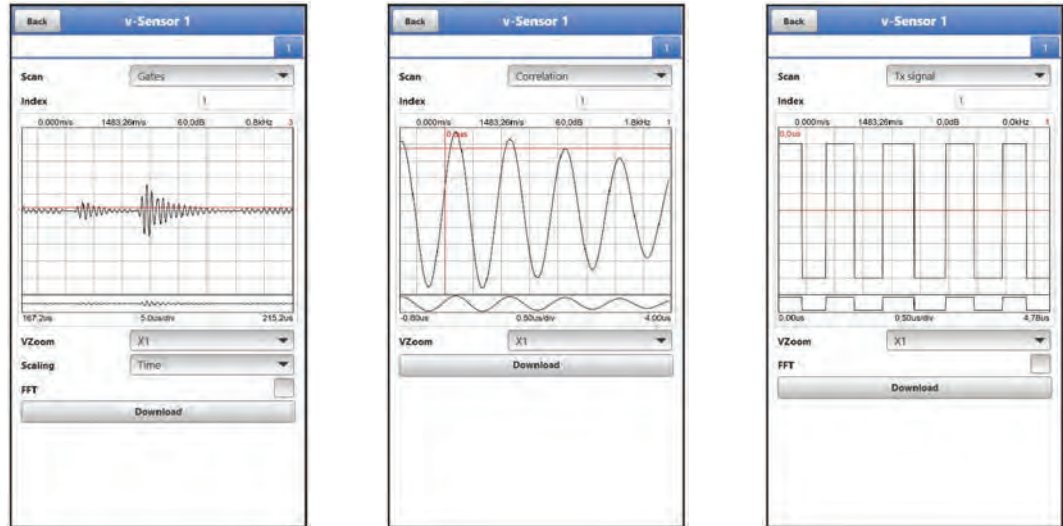

Fig. 52-2 Signal Analysis Gates / Correlation / Transmission Signal

- **>Correlation<**
Optical comparison of the two signals, corresponding to the movement of the particles in the medium. The red number at the top right of the graphic stands for the respective signal displayed for the gates (these are displayed alternately on a continuous basis).
 - >Index<: Gates 1...16
 - >VZoom< of graphic: X1, X2, X5, X10, X20 and X50
 - >Download<

- **>Transmission Signal<**
Optical representation/shape of the signal. The shape of the curves depends on the sensor used and cannot be changed because they are stored in the firmware. The curves may appear different in the individual sub-areas (index), but this does not necessarily have to be the case. The red number at the top right of the graphic stands for the respective signal displayed for the sub-areas (these are displayed alternately on a continuous basis).
 - >Index<: sub-areas 1...8
 - >VZoom< of graphic: X1, X2, X5, X10, X20 and X50
 - >FFT<: for the representation of the frequency spectrum.
 - >Download<

- **>Noise<**
Display of unwanted background noise during signal evaluation.
 - >VZoom< of graphic: X1, X2, X5, X10, X20 and X50
 - >FFT<: for the representation of the frequency spectrum.
 - >Download<

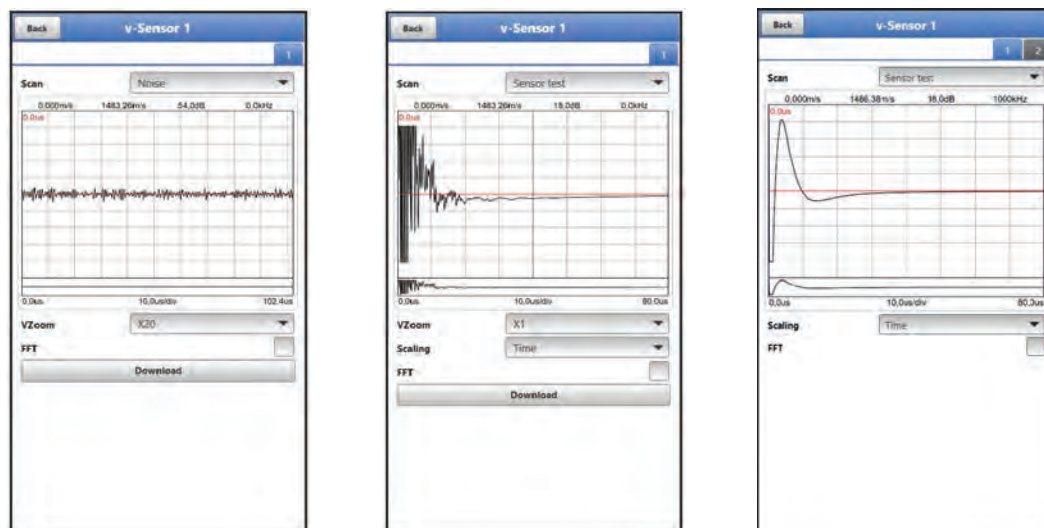

Fig. 52-3 Signal Analysis Noise / Sensor Test OK / No Sensor detected

- **>Sensor Test<**
Function test of a connected sensor; obstacles such as air and deposits are detected. If no sensor is detected (defective, cable break etc.) the curve appears like in the right picture in Fig. 52-3.
 - >VZoom< of graphic: X1, X2, X5, X10, X20 and X50
 - >Scaling< of graphic: time or distance
 - >FFT<: to display the frequency spectrum; if the checkmark is set, the selection for scaling the graph is omitted.
 - >Download<

53 Simulation

DANGER



Effect on Plant Sections

A simulation of the NivuFlow Mobile outputs directly accesses all downstream plant sections without any safety interlock.

Observe the regulations of the warning notice on page 153!

The simulation is terminated with the "Back" field.

In this menu, a theoretical flow can be simulated. The simulation is carried out by entering assumed filling level and velocity values. These values are **not** real.

The entry can be made in small steps via the fields >--<, >-<, >+< or >++< or to specify absolute (larger) values directly via >Velocity<.

- = Reduce the fill level by 0.01 m at a time or the velocity by 0.01 m/s at a time
- = Reduce the fill level by 0.001 m at a time or the velocity by 0.001 m/s at a time
- + = Increase the fill level by 0.001 m at a time or the velocity by 0.001 m/s at a time
- ++ = Increase the fill level by 0.01 m at a time or the velocity by 0.01 m/s at a time

The NivuFlow Mobile uses these simulated values (based on the dimensions of the parameterised channel) to calculate the prevailing flow value.

In >Flow< the value that was calculated is automatically displayed.

>DO1< indicates which function is currently selected.

In >Analogue Output<, the voltage present at the previously defined output is shown.



Fig. 53-1 Simulation

Maintenance and Cleaning

WARNING



Disconnect the System from Mains Power

Disconnect the unit from the mains power and secure the higher system against being switched on again before starting maintenance, cleaning and/or repair work (only by qualified personnel).

Disregarding may lead to electric shock.

WARNING



Check danger due to explosive gases

Before starting assembly, installation and maintenance work, be sure to check that all regulations on safety at work have been observed and that there is no possible risk of explosive gases. Use a gas warner for the check.

When working in the sewer system, make sure that no electrostatic charge can occur:

- Avoid unnecessary movements to reduce the building-up of static charges.
- Discharge any static electricity present on your body before you start installing the sensor.

Disregarding may result in personal injury or damage to the system.

WARNING



Open the device only out of Ex areas

Do not open, service or repair in an area where an explosive atmosphere is present.

WARNING



Germ Contamination

Due to the frequent use of the sensors in the waste water sector, parts can be contaminated with dangerous germs. Therefore, appropriate precautions must be taken when coming into contact with cables and sensors.

Wear protective clothing.

54 Maintenance

54.1 Maintenance Interval

The Type NivuFlow Mobile transmitter is virtually free of calibration, maintenance and wear by design.

Nevertheless, NIVUS recommend an **annual check** of the entire measuring system by the NIVUS customer service.

Depending on the area of application of the measuring system, the maintenance interval may vary. The scope of maintenance and its intervals depend on the following factors:

- Measurement principle of the sensors
- Material wear
- Measurement medium and channel hydraulics
- General regulations for the operator of the measurement system
- Environmental conditions

In addition to the annual maintenance, NIVUS recommend a complete maintenance of the measuring system by the NIVUS customer service after **ten years at the latest**.

Generally the verification of instruments and sensors is a basic measure in order to improve operational reliability and to increase the lifetime.

Contact the NIVUS customer service to make an appointment (see Chap. "54.3 Customer Service Information").

54.2 Maintenance Tasks

54.2.1 Clean, check and replace Seals

The front panel seals (at the edge of the battery compartments) and the enclosure cover seals of the transmitter must be maintained/checked (at least) **every time** the battery compartment or the housing cover **is closed**:

- Remove foreign bodies and dirt.
- Check elasticity.
- Check for damage.
- Ensure correct fit.
- Treat the seals with silicone grease if necessary.
- Replace defective seals (by NIVUS customer service).

For correct replacement of the seals, NIVUS recommend to return the transmitter to NIVUS. Contact the NIVUS customer service to make an appointment (see Chap. "54.3 Customer Service Information").

54.3 Customer Service Information

For the recommended annual inspection of the entire measuring system or complete maintenance after ten years at the latest, contact our customer service:

NIVUS GmbH - Customer Centre

Phone +49 7262 9191-922

customercenter@nivus.com

55 Cleaning

55.1 Transmitter

WARNING



Disconnect the System from Mains Power

Make sure that the device is disconnected from mains power.

Disregarding may lead to electric shock.

DANGER



Danger by electrostatic Discharge

Clean the device only with a damp cloth.

In case of disregard, the explosion protection of the device is no longer given due to possible static charge.

The device then poses a danger to the life of the user and can cause the ignition of an explosive atmosphere.

The NivuFlow Mobile enclosure complies with protection class IP68 when closed and is not very sensitive. Nevertheless, a high-pressure cleaner should **not** be used for cleaning.

Also, do **not** use harsh cleaning agents or solvents. Instead, it is better to use mild household cleaners or soap suds.

55.2 Rechargeable Battery Blocks

Do not use ethanol, petrol or other organic solvents or cleaning agents and surface-active agents for cleaning.

Instead, it is better to use mild household cleaners or soap suds.

55.3 Power Adapter/Charger

Clean the power adapter/charger and charging tray only with a **slightly damp** cloth. The components do not have any protection against the ingress of moisture.

55.4 Sensors

Be sure to follow the instructions for maintenance and cleaning of the sensors. These instructions can be found in the respective technical description or instruction manual.

These manuals are provided with the respective sensors and/or are available as download on the NIVUS homepage.

56 Dismantling/Disposal

Improper disposal may be harmful to the environment.

➡ Dispose of device components and packaging materials in accordance with the applicable local environmental regulations for electrical products:

1. Disconnect the device from mains power, if connected.
2. Remove connected cables from the device.
3. Remove rechargeable battery blocks and, if they are defective, dispose of them properly.
4. Remove the buffer battery from the transmitter and dispose of it separately and properly.



EU WEEE Directive

This symbol indicates that the requirements of Directive 2012/19/EU on waste electrical and electronic equipment must be observed when disposing of the device. Die NIVUS GmbH support and promote the recycling or environmentally sound, separate collection/disposal of waste electrical and electronic equipment to protect the environments and human health. Observe the local laws and regulations on disposal.

NIVUS GmbH are registered with the EAR, therefore public collection and return points in Germany can be used for disposal.

The device is equipped with a buffer battery (lithium button cell) that must be disposed of separately.

57 Installation of Spare Parts and Wearing Parts

We expressly draw your attention to the fact that spare parts and accessories which have not been supplied by us have also not been tested and approved by us. The installation and/or use of such products may therefore negatively alter or invalidate the design properties of your measurement system.

NIVUS are not liable for damage caused by the use of non-original parts and non-original accessories.

58 Accessories

Article Number	Description
<i>NFM0 ZAPB 1215</i>	Rechargeable battery block with connection sockets for NFM; nominal voltage: 12 V; capacity: 15 Ah
<i>NFM0 ZAPB 1215 E</i>	Rechargeable battery block with connection sockets for NFM with ATEX approval zone 1; nominal voltage: 12 V; capacity: 15 Ah
<i>NFM0 ZLAD</i>	Power adapter/charger for NFM / NFM rechargeable battery block supply voltage: 100...240 V AC, 50/60 Hz
<i>NFM0 ZVER PS</i>	Connection cable 2-wire for connecting an external supply voltage to the NFM (one side with plug for the multifunction socket, other side with open cable end); cable length 5 m
<i>NFM0 ZAB 01</i>	Display and operating module for NFM: IP67-certified 8" outdoor display; resolution: 1280x800; Operating system: Android; Device communication: WLAN; other communication types: USB, Bluetooth, modem 2G, 3G and 4G
<i>NFM0 ZVER AA</i>	Connection cable, NFM analogue output (one side with plug for the multifunction socket, other side with open cable ends); cable length 10 m
<i>NFM0 ZVER AEA</i>	Connection cable, NFM analogue input; power supply via NFM (one side with plug for the multifunction socket, other side with open cable ends); cable length 10 m
<i>NFM0 ZVER AEP</i>	Connection cable, NFM analogue input; external power supply (one side with plug for the multifunction socket, other side with open cable ends); cable length 10 m
<i>NFM0 ZVER DE</i>	Connection cable, NFM digital input; power supply via NFM (one side with plug for the multifunction socket, other side with open cable ends); cable length 10 m
<i>NFM0 ZVER DA</i>	Connection cable, NFM relays output (one side with plug for the multifunction socket, other side with open cable ends); cable length 10 m
<i>NFM0 ZVS1</i>	Connector Box, IP67 with NFM connection plug for connection to the NFM
<i>ZUB0 KAB NMC 10</i>	2-pole, pre-assembled cable with open cable ends for connection to the Connector Box; cable length 10 m
<i>ZUB0 KAB NMC 20</i>	2-pole, pre-assembled cable with open cable ends for connection to the Connector Box; cable length 20 m
<i>ZUB0 KAB NMC 30</i>	2-pole, pre-assembled cable with open cable ends for connection to the Connector Box; cable length 30 m
<i>NFM0 ZAB2 VKK</i>	Adapter box for flow velocity measurement using 3 flow velocity sensors on the NFM 750
<i>NFM0 ZSBL IRE</i>	Hoop guards (pair), for protecting the connector plugs and fixing the Connector Box to the NFM
<i>NFM0 ZHAK NFM 01</i>	Suspension bracket to fasten NFM on a step iron incl. hanging bracket for sensor cable; material: stainless steel 1.4571
<i>NFM0 ZHAK NFM 02</i>	Suspension bracket to fasten NFM on a step iron; material: stainless steel 1.4571
<i>NFM5 GUMMI PUFFER</i>	Rubber buffer, set with 4 pcs.

<i>NFM0 Z ANT1</i>	NFM GPRS T-shape antenna Ex-It GSM/3G, cable length 2.5 m, for connection to NFM with GPRS remote data transmission
<i>ZUB0 NFM SCHLOSS</i>	Padlock for transmitter in Ex version (to secure the device when used in Ex areas)
<i>ZUB0 NFM MAGNET</i>	Ring magnet for NFM, mounted
<i>BSL0 EP 220-20</i>	EnerPro 220 Tr / 20kA, mains line overvoltage protection
<i>BSL0 EP 220-5</i>	EnerPro 220 Tr / 5kA, mains line overvoltage protection
<i>BSL0 DP 2X12/12</i>	DataPro 2x1-12V/12V-11H- μ Tr(N), 20,000 A leakage current, 2-wire for sensor lines
	<p>NIVUS WebPortal: Data management system for storage and provision of measurement data. Multiple options for direct measurement data analysis, system verification, data forwarding and alarming, right up to complete log generation through processing in the cloud. For details, please contact your sales representative.</p>
	<p>NIVUS DataKiosk / Data Kiosk Client: NIVUS DataKiosk is a web-based connectivity platform for the secure provision of measurement and process data to upstream or downstream systems such as a process control system. Due to its open architecture, NIVUS DataKiosk connects IoT solutions with a wide variety of IT systems and makes necessary data format adaptations. DataKiosk fulfils the function of a gateway. It enables application programmes to read data from a wide variety of devices and pass on control signals to devices on the basis of standardised internet technologies. Through comprehensive networking and automation, processes can be improved overall and their utility can be increased. The NIVUS DataKiosk Client is a graphical interface that retrieves the data from the DataKiosk and automatically stores the result in a configurable location. For details, please contact your sales representative.</p>

Tab. 10 Spare Parts and Accessories



More accessories and spare parts can be found in the current NIVUS price list.

Index

2	2G/3G/4G Antenna.....45	F	Float, v-Sensor94 Flow Profile Diagnostics154
A	Accessories162 Adhesive plates21, 22, 33 Alarm60, 80, 140 Antenna45 Approvals167 Ex26 other26	G	Gates Diagnostics155 Germs17 GPRS129 DNS131 E-Mail133 FTP132 Modem State130 MQTT132 SIM Card130
B	Battery charger Specifications27 Buffer Battery17, 121, 161	H	h suppressed88 h-crit103 h-crit automatic100 h-manual100 Hoop guards22 Humidity26
C	Capacity Indicator Rechargeable/Battery135 Certificates167 Channel Profiles82 Charger12, 36, 39, 44, 162 Cleaning161 Charging tray37, 39 Cleaning161 Cleaning160 Codes166 Colour Code Wires12 Copyright3 Copyrights3 Correlation Diagnostics156 Credits166 Customer Centre160	I	Immersion Depth, Float97 Inspect Diagnostics155 Inspection upon Receipt21 Installation33 Intended Use18
D	Damping88 Device ID25 Device Versions27 Disclaimer18	L	Licences166 Licensing Issues166 Low-Flow87
E	Enclosure26 Error Messages60, 122	M	Maintenance Interval159 Maximum Measurement Duration88 Measurement Principles26 Minimum Measurement Duration88
		N	Nameplates25 Names3 Noise Diagnostics156

O	Operation Temperature26		Transport22
	Operator's Duties.....20		T-Shape Antenna45
	Overview.....23	U	
	Overvoltage Protection.....42		USB Stick 69, 114
P		V	
	Power Adapter..... 26, 36, 39, 44, 162		v suppressed88
	Cleaning.....161		v-crit.....103
	Power Supply26		v-Determination Automatic.....99
	Powerdown.....123		v-manual.....100
	Precautions 17		v-Maximum103
	Product Construction.....23		v-Minimum103
	Property Rights.....3	W	
	Protection26, 34		Wake-Up
	Protection class 160		Android.....48
Q			iOS52
	Q suppressed87		Windows.....56
	Q-manual.....100, 102		Warranty18
	Quick Start.....60, 69, 79, 136		Wearing Parts.....161
R			Wires
	Rechargeable Battery Blocks		Colour Code12
	Cleaning.....161		WLAN129
	Repeated measurement of the same		
	measurement places67		
	Restart.....123		
	Return.....22		
	Rubber buffers.....22, 162		
S			
	Safety Measures17		
	Scope of Delivery21		
	Sensor Test		
	Diagnostics157		
	Sensor Types40, 94		
	Service Level.....123		
	Service Symbol58		
	Signal analysis		
	Diagnostics155		
	Simulation		
	Important Information.....153		
	Sludge Level.....87		
	Spare Parts161		
	Stability88		
	Storage22		
	Storage Temperature26		
	System Time121		
T			
	Translation.....3		
	Transmission Signal		
	Diagnostics156		

Credits and Licenses

59 List of Sources of the Licences and Codes used

The transmitter type NivuFlow Mobile uses code from the following open source projects:

- Freetype (<http://www.freetype.org>)
- Libharu (<http://libharu.org>)
- Libjpeg (<http://www.ijg.org>)
- Libpng (<http://www.libpng.org>)
- Zlib (<http://www.zlib.net>)
- Mini-XML (<http://www.msweet.org>)
- Nano-X/nxlib (<http://www.microwindows.org>)
- FLTK (<http://www.fltk.org>)
- Appendix1: LGPL
- Appendix2: MPL



Licensing Issues

For questions on licensing contact opensource@nivus.com

Approvals and Certificates

DE / EN / FR

EU Konformitätserklärung

EU Declaration of Conformity
Déclaration de conformité UE



NIVUS GmbH
 Im Täle 2
 75031 Eppingen

Telefon: +49 07262 9191-0
 Telefax: +49 07262 9191-999
 E-Mail: info@nivus.com
 Internet: www.nivus.de

Für das folgend bezeichnete Erzeugnis:
For the following product:
Le produit désigné ci-dessous:

Bezeichnung:	Portabler Durchflussmessumformer/-datenlogger, Standardausführung NivuFlow Mobile / NivuLevel Mobile
<i>Description:</i>	<i>Portable flow measurement transmitter/data logger, standard version NivuFlow Mobile / NivuLevel Mobile</i>
<i>Désignation:</i>	<i>Débitmètre/enregistreur de données portable, version standard NivuFlow Mobile / NivuLevel Mobile</i>
Typ / Type:	NFM0xxx00 00

erklären wir in alleiniger Verantwortung, dass die auf dem Unionsmarkt ab dem Zeitpunkt der Unterzeichnung bereitgestellten Geräte die folgenden einschlägigen Harmonisierungsvorschriften der Union erfüllen:
we declare under our sole responsibility that the equipment made available on the Union market as of the date of signature of this document meets the standards of the following applicable Union harmonisation legislation:
nous déclarons, sous notre seule responsabilité, à la date de la présente signature, la conformité du produit pour le marché de l'Union, aux directives d'harmonisation de la législation au sein de l'Union:

- 2014/53/EU
- 2011/65/EU

Bei der Bewertung wurden folgende einschlägige harmonisierte Normen zugrunde gelegt bzw. wird die Konformität erklärt in Bezug auf die nachfolgend genannten anderen technischen Spezifikationen:
The evaluation assessed the following applicable harmonised standards or the conformity is declared in relation to other technical specifications listed below:
L'évaluation est effectuée à partir des normes harmonisées applicable ou la conformité est déclarée en relation aux autres spécifications techniques désignées ci-dessous:

- EN 61010-1:2010 + A1:2019 + A1:2019/AC:2019
- EN 61326-1:2013
- ETSI EN 301 489-17 V3.2.5
- EN 301 893 V2.1.1 (WLAN)
- EN 62311:2008
- ETSI EN 301 489-1 V2.2.3
- EN 300 328 V2.2.2 (WLAN)
- EN 300 440 V2.2.1 (WLAN)

Diese Erklärung wird verantwortlich für den Hersteller:
This declaration is submitted on behalf of the manufacturer:
Le fabricant assume la responsabilité de cette déclaration:

NIVUS GmbH
Im Täle 2
75031 Eppingen
Germany

abgegeben durch / *represented by / faite par:*
Ingrid Steppe (Geschäftsführerin / *Managing Director / Directeur général*)

Eppingen, den 21.10.2022

Gez. *Ingrid Steppe*

UK Declaration of Conformity

NIVUS GmbH
Im Tale 2
75031 Eppingen

Telefon: +49 07262 9191-0
Telefax: +49 07262 9191-999
E-Mail: info@nivus.com
Internet: www.nivus.de

For the following product:

Description:	Portable flow measurement transmitter/data logger, standard version NivuFlow Mobile / NivuLevel Mobile
Type:	NFM0xxx00 00

we declare under our sole responsibility that the equipment made available on the UK market as of the date of signature of this document meets the standards of the following applicable UK harmonisation legislation:

- SI 2017 / 1206 The Radio Equipment Regulations 2017
- SI 2012 / 3032 The Restriction of the Use of Certain Hazardous Substances in Electrical and Electronic Equipment Regulations 2012

The evaluation assessed the following applicable harmonised standards or the conformity is declared in relation to other technical specifications listed below:

- BS EN 61010-1:2010 + A1:2019 + A1:2019/AC:2019
- BS EN 61326-1:2013
- ETSI EN 301 489-17 V3.2.5
- BS EN 301 893 V2.1.1 (WLAN)
- BS EN 62311:2008
- ETSI EN 301 489-1 V2.2.3
- BS EN 300 328 V2.2.2 (WLAN)
- BS EN 300 440 V2.2.1 (WLAN)

This declaration is submitted on behalf of the manufacturer:

NIVUS GmbH
Im Taele 2
75031 Eppingen
Germany

represented by:

Ingrid Steppe (Managing Director)

Eppingen, 21/10/2022

Signed by *Ingrid Steppe*

EU Konformitätserklärung

EU Declaration of Conformity

Déclaration de conformité UE

Für das folgend bezeichnete Erzeugnis:

For the following product:

Le produit désigné ci-dessous:



NIVUS GmbH
Im Taele 2
75031 Eppingen

Telefon: +49 07262 9191-0
Telefax: +49 07262 9191-999
E-Mail: info@nivus.com
Internet: www.nivus.de

Bezeichnung:	"Ex" Portabler Durchflussmessumformer/-datenlogger, Standardausführung NivuFlow Mobile / NivuLevel Mobile
<i>Description:</i>	<i>"Ex" Portable flow measurement transmitter/data logger, standard version NivuFlow Mobile / NivuLevel Mobile</i>
<i>Désignation:</i>	<i>"Ex" Débitmètre/enregistreur de données portable, version standard NivuFlow Mobile / NivuLevel Mobile</i>
Typ / Type:	NFM0xx0E 0x

erklären wir in alleiniger Verantwortung, dass die auf dem Unionsmarkt ab dem Zeitpunkt der Unterzeichnung bereitgestellten Geräte die folgenden einschlägigen Harmonisierungsvorschriften der Union erfüllen:

we declare under our sole responsibility that the equipment made available on the Union market as of the date of signature of this document meets the standards of the following applicable Union harmonisation legislation:

nous déclarons, sous notre seule responsabilité, à la date de la présente signature, la conformité du produit pour le marché de l'Union, aux directives d'harmonisation de la législation au sein de l'Union:

- 2014/53/EU
- 2014/34/EU
- 2011/65/EU

Bei der Bewertung wurden folgende einschlägige harmonisierte Normen zugrunde gelegt bzw. wird die Konformität erklärt in Bezug auf die nachfolgend genannten anderen technischen Spezifikationen:

The evaluation assessed the following applicable harmonised standards or the conformity is declared in relation to other technical specifications listed below:

L'évaluation est effectuée à partir des normes harmonisées applicable ou la conformité est déclarée en relation aux autres spécifications techniques désignées ci-dessous:

- EN 61010-1:2010 + A1:2019 + A1:2019/AC:2019
- EN 61326-1:2013
- Draft ETSI EN 301 489-17 V3.2.5
- EN 301 893 V2.1.1 (WLAN)
- EN IEC 60079-0:2018
- EN 60079-11:2012
- EN 62311:2008
- Draft ETSI EN 301 489-1 V2.2.3
- EN 300 328 V2.2.2 (WLAN)
- EN 300 440 V2.2.1 (WLAN)
- EN IEC 60079-7:2015/A1:2018
- EN 60079-18:2015/A1:2017

Ex-Kennzeichnung / *Ex-designation* / *Marquage Ex* :

 II 2G Ex eb ib [ib] mb IIB T4 Gb

EU-Baumusterprüfbescheinigung / *EU-Type Examination Certificate* / *Attestation d'examen «UE» de type:*

TÜV 17 ATEX 196722 X issue: 01

Notifizierte Stelle (Kennnummer) / *Notified Body (Identif. No.) / Organisme notifié (N° d'identification)*

TÜV NORD CERT GmbH, Am TÜV 1, 45307 Essen, Germany

(0044)

Diese Erklärung wird verantwortlich für den Hersteller:

This declaration is submitted on behalf of the manufacturer:

Le fabricant assume la responsabilité de cette déclaration:

NIVUS GmbH
Im Taele 2
75031 Eppingen
Germany

abgegeben durch / *represented by / faite par:*

Ingrid Steppe (Geschäftsführerin / *Managing Director / Directeur général*)

Eppingen, den 21.10.2022

Gez. *Ingrid Steppe*

UK Declaration of Conformity

NIVUS GmbH
Im Täle 2
75031 Eppingen

Telefon: +49 07262 9191-0
Telefax: +49 07262 9191-999
E-Mail: info@nivus.com
Internet: www.nivus.de

For the following product:

Description:	"Ex" Portable flow measurement transmitter/data logger, standard version NivuFlow Mobile / NivuLevel Mobile
Type:	NFM0xxx0E 0x

we declare under our sole responsibility that the equipment made available on the UK market as of the date of signature of this document meets the standards of the following applicable UK harmonisation legislation:

- SI 2017 / 1206 The Radio Equipment Regulations 2017
- SI 2016 / 1107 The Equipment and Protective Systems Intended for use in Potentially Explosive Atmospheres Regulations 2016
- SI 2012 / 3032 The Restriction of the Use of Certain Hazardous Substances in Electrical and Electronic Equipment Regulations 2012

The evaluation assessed the following applicable harmonised standards or the conformity is declared in relation to other technical specifications listed below:

- BS EN 61010-1:2010 + A1:2019 + A1:2019/AC:2019
- BS EN 61326-1:2013
- Draft ETSI EN 301 489-17 V3.2.5
- BS EN 301 893 V2.1.1 (WLAN)
- BS EN IEC 60079-0:2018
- BS EN 60079-11:2012
- BS EN 62311:2008
- Draft ETSI EN 301 489-1 V2.2.3
- BS EN 300 328 V2.2.2 (WLAN)
- BS EN 300 440 V2.2.1 (WLAN)
- BS EN IEC 60079-7:2015/A1:2018
- BS EN 60079-18:2015/A1:2017

Ex-designation:

 I 2G Ex eb ib [ib] mb IIB T4 Gb

EU-Type Examination Certificate:

TÜV 17 ATEX 196722 X issue: 01

Notified Body (Identif. No.):

TÜV Nord CERT GmbH, Am TÜV 1, 45307 Essen, Germany

(0044)

This declaration is submitted on behalf of the manufacturer:

NIVUS GmbH
Im Täle 2
75031 Eppingen
Germany

represented by:

Ingrid Steppe (Managing Director)

Eppingen, 21/10/2022

Signed by *Ingrid Steppe*

DE / EN / FR

EU Konformitätserklärung

EU Declaration of Conformity

Déclaration de conformité UE



NIVUS GmbH
Im Täle 2
75031 Eppingen

Telefon: +49 07262 9191-0
Telefax: +49 07262 9191-999
E-Mail: info@nivus.com
Internet: www.nivus.de

Für das folgend bezeichnete Erzeugnis:

For the following product:

Le produit désigné ci-dessous:

Bezeichnung:	Portabler Durchflussmessumformer/-datenlogger mit internem Modem zur Datenfernübertragung über GPRS/UMTS/LTE NivuFlow Mobile/NivuLevel Mobile
<i>Description:</i>	<i>Portable flow measurement transmitter/data logger with internal modem for data transmission via GPRS/UMTS/LTE NivuFlow Mobile/NivuLevel Mobile</i>
<i>Désignation:</i>	<i>Débitmètre/enregistreur de données portable avec modem interne pour la transmission de données à distance via GPRS/UMTS/LTE NivuFlow Mobile/NivuLevel Mobile</i>
Typ / Type:	NFM0xxxG0 Ex

erklären wir in alleiniger Verantwortung, dass die auf dem Unionsmarkt ab dem Zeitpunkt der Unterzeichnung bereitgestellten Geräte die folgenden einschlägigen Harmonisierungsvorschriften der Union erfüllen:

we declare under our sole responsibility that the equipment made available on the Union market as of the date of signature of this document meets the standards of the following applicable Union harmonisation legislation:

nous déclarons, sous notre seule responsabilité, à la date de la présente signature, la conformité du produit pour le marché de l'Union, aux directives d'harmonisation de la législation au sein de l'Union:

- 2014/53/EU
- 2011/65/EU

Bei der Bewertung wurden folgende einschlägige harmonisierte Normen zugrunde gelegt bzw. wird die Konformität erklärt in Bezug auf die nachfolgend genannten anderen technischen Spezifikationen:

The evaluation assessed the following applicable harmonised standards or the conformity is declared in relation to other technical specifications listed below:

L'évaluation est effectuée à partir des normes harmonisées applicable ou la conformité est déclarée en relation aux autres spécifications techniques désignées ci-dessous:

- EN 61010-1:2010 + A1:2019 + A1:2019/AC:2019
- EN 61326-1:2013
- Draft ETSI EN 301 489-17 V3.2.5
- Draft ETSI EN 301 489-52 V1.2.1
- EN 301 893 V2.1.1 (WLAN)
- EN 301 511 V12.5.1 (GSM/2G)
- EN 301 908-2 V13.1.1 (UMTS/3G)
- EN 62311:2008
- EN 301 489-1 V2.2.3
- Draft ETSI EN 301 489-19 V2.2.1
- EN 300 328 V2.2.2 (WLAN)
- EN 300 440 V2.2.1 (WLAN)
- EN 301 908-1 V15.2.0 (UMTS/3G, LTE/4G)
- EN 301 908-13 V13.2.1 (LTE/4G)

Diese Erklärung wird verantwortlich für den Hersteller:

This declaration is submitted on behalf of the manufacturer:

Le fabricant assume la responsabilité de cette déclaration:

NIVUS GmbH
Im Täle 2
75031 Eppingen
Germany

abgegeben durch / represented by / faite par:

Ingrid Steppe (Geschäftsführerin / Managing Director / Directeur général)

Eppingen, den 21.10.2022

Gez. *Ingrid Steppe*

UK Declaration of Conformity

NIVUS GmbH
Im Tale 2
75031 Eppingen

Telefon: +49 07262 9191-0
Telefax: +49 07262 9191-999
E-Mail: info@nivus.com
Internet: www.nivus.de

For the following product:

Description:	Portable flow measurement transmitter/data logger with internal modem for data transmission via GPRS/UMTS/LTE NivuFlow Mobile/NivuLevel Mobile
Type:	NFM0xxxG0 Ex

we declare under our sole responsibility that the equipment made available on the UK market as of the date of signature of this document meets the standards of the following applicable UK harmonisation legislation:

- SI 2017 / 1206 The Radio Equipment Regulations 2017
- SI 2012 / 3032 The Restriction of the Use of Certain Hazardous Substances in Electrical and Electronic Equipment Regulations 2012

The evaluation assessed the following applicable harmonised standards or the conformity is declared in relation to other technical specifications listed below:

- BS EN 61010-1:2010 + A1:2019 + A1:2019/AC:2019
- BS EN 61326-1:2013
- Draft ETSI EN 301 489-17 V3.2.5
- Draft ETSI EN 301 489-52 V1.2.1
- BS EN 301 893 V2.1.1 (WLAN)
- BS EN 301 511 V12.5.1 (GSM/2G)
- BS EN 301 908-2 V13.1.1 (UMTS/3G)
- BS EN 62311:2008
- BS EN 301 489-1 V2.2.3
- Draft ETSI EN 301 489-19 V2.2.1
- BS EN 300 328 V2.2.2 (WLAN)
- BS EN 300 440 V2.2.1 (WLAN)
- BS EN 301 908-1 V15.2.0 (UMTS/3G, LTE/4G)
- BS EN 301 908-13 V13.2.1 (LTE/4G)

This declaration is submitted on behalf of the manufacturer:

NIVUS GmbH
Im Tale 2
75031 Eppingen
Germany

represented by:

Ingrid Steppe (Managing Director)

Eppingen, 21/10/2022

Signed by *Ingrid Steppe*

EU Konformitätserklärung

EU Declaration of Conformity

Déclaration de conformité UE

Für das folgend bezeichnete Erzeugnis:

For the following product:

Le produit désigné ci-dessous:



NIVUS GmbH
Im Täle 2
75031 Eppingen

Telefon: +49 07262 9191-0
Telefax: +49 07262 9191-999
E-Mail: info@nivus.com
Internet: www.nivus.de

Bezeichnung:	Portabler Durchflussmessumformer/-datenlogger mit internem Modem zur Datenfernübertragung über GPRS/UMTS/LTE NivuFlow Mobile/NivuLevel Mobile
<i>Description:</i>	<i>Portable flow measurement transmitter/data logger with internal modem for data transmission via GPRS/UMTS/LTE NivuFlow Mobile/NivuLevel Mobile</i>
<i>Désignation:</i>	<i>Débitmètre/enregistreur de données portable avec modem interne pour la transmission de données à distance via GPRS/UMTS/LTE NivuFlow Mobile/NivuLevel Mobile</i>
Typ / Type:	NFM0xxxG0 Gx

erklären wir in alleiniger Verantwortung, dass die auf dem Unionsmarkt ab dem Zeitpunkt der Unterzeichnung bereitgestellten Geräte die folgenden einschlägigen Harmonisierungsvorschriften der Union erfüllen:

we declare under our sole responsibility that the equipment made available on the Union market as of the date of signature of this document meets the standards of the following applicable Union harmonisation legislation:

nous déclarons, sous notre seule responsabilité, à la date de la présente signature, la conformité du produit pour le marché de l'Union, aux directives d'harmonisation de la législation au sein de l'Union:

- 2014/53/EU
- 2011/65/EU

Bei der Bewertung wurden folgende einschlägige harmonisierte Normen zugrunde gelegt bzw. wird die Konformität erklärt in Bezug auf die nachfolgend genannten anderen technischen Spezifikationen:

The evaluation assessed the following applicable harmonised standards or the conformity is declared in relation to other technical specifications listed below:

L'évaluation est effectuée à partir des normes harmonisées applicable ou la conformité est déclarée en relation aux autres spécifications techniques désignées ci-dessous:

- EN 61010-1:2010 + A1:2019 + A1:2019/AC:2019
- EN 61326-1:2013
- Draft ETSI EN 301 489-17 V3.2.5
- Draft ETSI EN 301 489-52 V1.2.1
- EN 301 893 V2.1.1 (WLAN)
- EN 301 511 V12.5.1 (GSM/2G)
- EN 301 908-2 V13.1.1 (UMTS/3G)
- EN 62311:2008
- EN 301 489-1 V2.2.3
- Draft ETSI EN 301 489-19 V2.2.1
- EN 300 328 V2.2.2 (WLAN)
- EN 300 440 V2.2.1 (WLAN)
- EN 301 908-1 V15.2.0 (UMTS/3G, LTE/4G)
- EN 301 908-13 V13.2.1 (LTE/4G)

Diese Erklärung wird verantwortlich für den Hersteller:

This declaration is submitted on behalf of the manufacturer:

Le fabricant assume la responsabilité de cette déclaration:

NIVUS GmbH
Im Täle 2
75031 Eppingen
Germany

abgegeben durch / represented by / faite par:

Ingrid Steppe (Geschäftsführerin / Managing Director / Directeur général)

Eppingen, den 21.10.2022

Gez. *Ingrid Steppe*

UK Declaration of Conformity

NIVUS GmbH
Im Tale 2
75031 Eppingen

Telefon: +49 07262 9191-0
Telefax: +49 07262 9191-999
E-Mail: info@nivus.com
Internet: www.nivus.de

For the following product:

Description:	Portable flow measurement transmitter/data logger with internal modem for data transmission via GPRS/UMTS/LTE NivuFlow Mobile/NivuLevel Mobile
Type:	NFM0xxxG0 Gx

we declare under our sole responsibility that the equipment made available on the UK market as of the date of signature of this document meets the standards of the following applicable UK harmonisation legislation:

- SI 2017 / 1206 The Radio Equipment Regulations 2017
- SI 2012 / 3032 The Restriction of the Use of Certain Hazardous Substances in Electrical and Electronic Equipment Regulations 2012

The evaluation assessed the following applicable harmonised standards or the conformity is declared in relation to other technical specifications listed below:

- BS EN 61010-1:2010 + A1:2019 + A1:2019/AC:2019
- BS EN 61326-1:2013
- Draft ETSI EN 301 489-17 V3.2.5
- Draft ETSI EN 301 489-52 V1.2.1
- BS EN 301 893 V2.1.1 (WLAN)
- BS EN 301 511 V12.5.1 (GSM/2G)
- BS EN 301 908-2 V13.1.1 (UMTS/3G)
- BS EN 62311:2008
- EN 301 489-1 V2.2.3
- Draft ETSI EN 301 489-19 V2.2.1
- BS EN 300 328 V2.2.2 (WLAN)
- BS EN 300 440 V2.2.1 (WLAN)
- BS EN 301 908-1 V15.2.0 (UMTS/3G, LTE/4G)
- BS EN 301 908-13 V13.2.1 (LTE/4G)

This declaration is submitted on behalf of the manufacturer:

NIVUS GmbH
Im Tale 2
75031 Eppingen
Germany

represented by:

Ingrid Steppe (Managing Director)

Eppingen, 21/10/2022

Signed by *Ingrid Steppe*

DE / EN / FR



EU Konformitätserklärung

EU Declaration of Conformity

Déclaration de conformité UE

Für das folgend bezeichnete Erzeugnis:

For the following product:

Le produit désigné ci-dessous:

NIVUS GmbH
Im Taele 2
75031 Eppingen

Telefon: +49 07262 9191-0
Telefax: +49 07262 9191-999
E-Mail: info@nivus.com
Internet: www.nivus.de

Bezeichnung:	"Ex" Portabler Durchflussmessumformer/-datenlogger, mit internem Modem zur Datenfernübertragung über GPRS/UMTS/LTE NivuFlow Mobile / NivuLevel Mobile
<i>Description:</i>	<i>"Ex" Portable flow measurement transmitter/data logger, with internal modem for data transmission via GPRS/UMTS/LTE NivuFlow Mobile / NivuLevel Mobile</i>
<i>Désignation:</i>	<i>"Ex" Débitmètre/enregistreur de données portable avec modem interne pour la transmission de données à distance via GPRS/UMTS/LTE NivuFlow Mobile / NivuLevel Mobile</i>
Typ / Type:	NFM0xxxGE Ex

erklären wir in alleiniger Verantwortung, dass die auf dem Unionsmarkt ab dem Zeitpunkt der Unterzeichnung bereitgestellten Geräte die folgenden einschlägigen Harmonisierungsvorschriften der Union erfüllen:

we declare under our sole responsibility that the equipment made available on the Union market as of the date of signature of this document meets the standards of the following applicable Union harmonisation legislation:

nous déclarons, sous notre seule responsabilité, à la date de la présente signature, la conformité du produit pour le marché de l'Union, aux directives d'harmonisation de la législation au sein de l'Union:

- 2014/53/EU
- 2014/34/EU
- 2011/65/EU

Bei der Bewertung wurden folgende einschlägige harmonisierte Normen zugrunde gelegt bzw. wird die Konformität erklärt in Bezug auf die nachfolgend genannten anderen technischen Spezifikationen:

The evaluation assessed the following applicable harmonised standards or the conformity is declared in relation to other technical specifications listed below:

L'évaluation est effectuée à partir des normes harmonisées applicable ou la conformité est déclarée en relation aux autres spécifications techniques désignées ci-dessous:

- EN 61010-1:2010 + A1:2019 + A1:2019/AC:2019
- EN 61326-1:2013
- Draft ETSI EN 301 489-17 V3.2.5
- Draft ETSI EN 301 489-52 V1.2.1
- EN 301 893 V2.1.1 (WLAN)
- EN 301 511 V12.5.1 (GSM/2G)
- EN 301 908-2 V13.1.1 (UMTS/3G)
- EN IEC 60079-0:2018
- EN 60079-11:2012
- EN 62311:2008
- EN 301 489-1 V2.2.3
- Draft ETSI EN 301 489-19 V2.2.1
- EN 300 328 V2.2.2 (WLAN)
- EN 300 440 V2.2.1 (WLAN)
- EN 301 908-1 V15.2.0 (UMTS/3G, LTE/4G)
- EN 301 908-13 V13.2.1 (LTE/4G)
- EN IEC 60079-7:2015/A1:2018
- EN 60079-18:2015/A1:2017

Ex-Kennzeichnung / *Ex-designation* / *Marquage Ex* :

⊕ II 2G Ex eb ib [ib] mb IIB T4 Gb

EU-Baumusterprüfbescheinigung / *EU-Type Examination Certificate* / *Attestation d'examen «UE» de type:*

TÜV 17 ATEX 196722 X issue: 01

Notifizierte Stelle (Kennnummer) / *Notified Body (Identif. No.)* / *Organisme notifié (N° d'identification)*

TÜV NORD CERT GmbH, Am TÜV 1, 45307 Essen, Germany

(0044)

Diese Erklärung wird verantwortlich für den Hersteller:

This declaration is submitted on behalf of the manufacturer:

Le fabricant assume la responsabilité de cette déclaration:

NIVUS GmbH
Im Taele 2
75031 Eppingen
Allemagne

abgegeben durch / *represented by* / *faite par:*

Ingrid Steppe (Geschäftsführerin / *Managing Director* / *Directeur général*)

Eppingen, den 21.10.2022

Gez. *Ingrid Steppe*

UK Declaration of Conformity

NIVUS GmbH
Im Tale 2
75031 Eppingen

Telefon: +49 07262 9191-0
Telefax: +49 07262 9191-999
E-Mail: info@nivus.com
Internet: www.nivus.de

For the following product:

Description:	"Ex" Portable flow measurement transmitter/data logger, with internal modem for data transmission via GPRS/UMTS/LTE NivuFlow Mobile / NivuLevel Mobile
Type:	NFM0xxxGE Ex

we declare under our sole responsibility that the equipment made available on the UK market as of the date of signature of this document meets the standards of the following applicable UK harmonisation legislation:

- SI 2017 / 1206 The Radio Equipment Regulations 2017
- SI 2016 / 1107 The Equipment and Protective Systems Intended for use in Potentially Explosive Atmospheres Regulations 2016
- SI 2012 / 3032 The Restriction of the Use of Certain Hazardous Substances in Electrical and Electronic Equipment Regulations 2012

The evaluation assessed the following applicable harmonised standards or the conformity is declared in relation to other technical specifications listed below:

- BS EN 61010-1:2010 + A1:2019 + A1:2019/AC:2019
- BS EN 61326-1:2013
- Draft ETSI EN 301 489-17 V3.2.5
- Draft ETSI EN 301 489-52 V1.2.1
- BS EN 301 893 V2.1.1 (WLAN)
- BS EN 301 511 V12.5.1 (GSM/2G)
- BS EN 301 908-2 V13.1.1 (UMTS/3G)
- BS EN IEC 60079-0:2018
- BS EN 60079-11:2012
- BS EN 62311:2008
- BS EN 301 489-1 V2.2.3
- Draft ETSI EN 301 489-19 V2.2.1
- BS EN 300 328 V2.2.2 (WLAN)
- BS EN 300 440 V2.2.1 (WLAN)
- BS EN 301 908-1 V15.2.0 (UMTS/3G, LTE/4G)
- BS EN 301 908-13 V13.2.1 (LTE/4G)
- BS EN IEC 60079-7:2015/A1:2018
- BS EN 60079-18:2015/A1:2017

Ex-designation:

 II 2G Ex eb ib [ib] mb IIB T4 Gb

EU-Type Examination Certificate:

TÜV 17 ATEX 196722 X issue: 01

Notified Body (Identif. No.):

TÜV Nord CERT GmbH, Am TÜV 1, 45307 Essen, Germany

(0044)

This declaration is submitted on behalf of the manufacturer:

NIVUS GmbH
Im Tale 2
75031 Eppingen
Germany

represented by:

Ingrid Steppe (Managing Director)

Eppingen, 21/10/2022

Signed by *Ingrid Steppe*

DE / EN / FR

EU Konformitätserklärung

EU Declaration of Conformity

Déclaration de conformité UE

Für das folgend bezeichnete Erzeugnis:

For the following product:

Le produit désigné ci-dessous:



NIVUS GmbH
Im Tälle 2
75031 Eppingen

Telefon: +49 07262 9191-0
Telefax: +49 07262 9191-999
E-Mail: info@nivus.com
Internet: www.nivus.de

Bezeichnung:	"Ex" Portabler Durchflussmessumformer/-datenlogger, mit internem Modem zur Datenfernübertragung über GPRS/UMTS/LTE NivuFlow Mobile / NivuLevel Mobile
<i>Description:</i>	<i>"Ex" Portable flow measurement transmitter/data logger, with internal modem for data transmission via GPRS/UMTS/LTE NivuFlow Mobile / NivuLevel Mobile</i>
<i>Désignation:</i>	<i>"Ex" Débitmètre/enregistreur de données portable avec modem interne pour la transmission de données à distance via GPRS/UMTS/LTE NivuFlow Mobile / NivuLevel Mobile</i>
Typ / Type:	NFM0xxxGE Gx

erklären wir in alleiniger Verantwortung, dass die auf dem Unionsmarkt ab dem Zeitpunkt der Unterzeichnung bereitgestellten Geräte die folgenden einschlägigen Harmonisierungsvorschriften der Union erfüllen:

we declare under our sole responsibility that the equipment made available on the Union market as of the date of signature of this document meets the standards of the following applicable Union harmonisation legislation:

nous déclarons, sous notre seule responsabilité, à la date de la présente signature, la conformité du produit pour le marché de l'Union, aux directives d'harmonisation de la législation au sein de l'Union:

- 2014/53/EU
- 2014/34/EU
- 2011/65/EU

Bei der Bewertung wurden folgende einschlägige harmonisierte Normen zugrunde gelegt bzw. wird die Konformität erklärt in Bezug auf die nachfolgend genannten anderen technischen Spezifikationen:

The evaluation assessed the following applicable harmonised standards or the conformity is declared in relation to other technical specifications listed below:

L'évaluation est effectuée à partir des normes harmonisées applicable ou la conformité est déclarée en relation aux autres spécifications techniques désignées ci-dessous:

- EN 61010-1:2010 + A1:2019 + A1:2019/AC:2019
- EN 61326-1:2013
- Draft ETSI EN 301 489-17 V3.2.5
- Draft ETSI EN 301 489-52 V1.2.1
- EN 301 893 V2.1.1 (WLAN)
- EN 301 511 V12.5.1 (GSM/2G)
- EN 301 908-2 V13.1.1 (UMTS/3G)
- EN IEC 60079-0:2018
- EN 60079-11:2012
- EN 62311:2008
- EN 301 489-1 V2.2.3
- Draft ETSI EN 301 489-19 V2.2.1
- EN 300 328 V2.2.2 (WLAN)
- EN 300 440 V2.2.1 (WLAN)
- EN 301 908-1 V15.2.0 (UMTS/3G, LTE/4G)
- EN 301 908-13 V13.2.1 (LTE/4G)
- EN IEC 60079-7:2015/A1:2018
- EN 60079-18:2015/A1:2017

Ex-Kennzeichnung / *Ex-designation* / *Marquage Ex* :

⊕ II 2G Ex eb ib [ib] mb IIB T4 Gb

EU-Baumusterprüfbescheinigung / *EU-Type Examination Certificate* / *Attestation d'examen «UE» de type:*

TÜV 17 ATEX 196722 X issue: 01

Notifizierte Stelle (Kennnummer) / *Notified Body (Identif. No.) / Organisme notifié (N° d'identification)*

TÜV NORD CERT GmbH, Am TÜV 1, 45307 Essen, Germany

(0044)

Diese Erklärung wird verantwortlich für den Hersteller:

This declaration is submitted on behalf of the manufacturer:

Le fabricant assume la responsabilité de cette déclaration:

NIVUS GmbH
Im Tälle 2
75031 Eppingen
Germany

abgegeben durch / *represented by / faite par:*

Ingrid Steppe (Geschäftsführerin / *Managing Director / Directeur général*)

Eppingen, den 21.10.2022

Gez. *Ingrid Steppe*

UK Declaration of Conformity

NIVUS GmbH
Im Täle 2
75031 Eppingen

Telefon: +49 07262 9191-0
Telefax: +49 07262 9191-999
E-Mail: info@nivus.com
Internet: www.nivus.de

For the following product:

Description:	"Ex" Portable flow measurement transmitter/data logger, with internal modem for data transmission via GPRS/UMTS/LTE NivuFlow Mobile / NivuLevel Mobile
Type:	NFM0xxxGE Gx

we declare under our sole responsibility that the equipment made available on the UK market as of the date of signature of this document meets the standards of the following applicable UK harmonisation legislation:

- SI 2017 / 1206 The Radio Equipment Regulations 2017
- SI 2016 / 1107 The Equipment and Protective Systems Intended for use in Potentially Explosive Atmospheres Regulations 2016
- SI 2012 / 3032 The Restriction of the Use of Certain Hazardous Substances in Electrical and Electronic Equipment Regulations 2012

The evaluation assessed the following applicable harmonised standards or the conformity is declared in relation to other technical specifications listed below:

- BS EN 61010-1:2010 + A1:2019 + A1:2019/AC:2019
- BS EN 61326-1:2013
- Draft ETSI EN 301 489-17 V3.2.5
- Draft ETSI EN 301 489-52 V1.2.1
- BS EN 301 893 V2.1.1 (WLAN)
- BS EN 301 511 V12.5.1 (GSM/2G)
- BS EN 301 908-2 V13.1.1 (UMTS/3G)
- BS EN IEC 60079-0:2018
- BS EN 60079-11:2012
- BS EN 62311:2008
- BS EN 301 489-1 V2.2.3
- Draft ETSI EN 301 489-19 V2.2.1
- BS EN 300 328 V2.2.2 (WLAN)
- BS EN 300 440 V2.2.1 (WLAN)
- BS EN 301 908-1 V15.2.0 (UMTS/3G, LTE/4G)
- BS EN 301 908-13 V13.2.1 (LTE/4G)
- BS EN IEC 60079-7:2015/A1:2018
- BS EN 60079-18:2015/A1:2017

Ex-designation:

 II 2G Ex eb ib [ib] mb IIB T4 Gb

EU-Type Examination Certificate:

TÜV 17 ATEX 196722 X issue: 01

Notified Body (Identif. No.):

TÜV Nord CERT GmbH, Am TÜV 1, 45307 Essen, Germany

(0044)

This declaration is submitted on behalf of the manufacturer:

NIVUS GmbH
Im Täle 2
75031 Eppingen
Germany

represented by:

Ingrid Steppe (Managing Director)

Eppingen, 21/10/2022

Signed by *Ingrid Steppe*

DE / EN / FR

EU Konformitätserklärung

EU Declaration of Conformity

Déclaration de conformité UE

Für das folgend bezeichnete Erzeugnis:

For the following product:

Le produit désigné ci-dessous:



NIVUS GmbH
Im Taele 2
75031 Eppingen

Telefon: +49 07262 9191-0
Telefax: +49 07262 9191-999
E-Mail: info@nivus.com
Internet: www.nivus.de

Bezeichnung:	Ladeschale NFM
<i>Description:</i>	<i>charging station NFM</i>
<i>Désignation:</i>	<i>station de charge NFM</i>
Typ / Type:	NFM02 LADESCH

erklären wir in alleiniger Verantwortung, dass die auf dem Unionsmarkt ab dem Zeitpunkt der Unterzeichnung bereitgestellten Geräte die folgenden einschlägigen Harmonisierungsvorschriften der Union erfüllen:

we declare under our sole responsibility that the equipment made available on the Union market as of the date of signature of this document meets the standards of the following applicable Union harmonisation legislation:

nous déclarons, sous notre seule responsabilité, à la date de la présente signature, la conformité du produit pour le marché de l'Union, aux directives d'harmonisation de la législation au sein de l'Union:

- 2011/65/EU

Bei der Bewertung wurden folgende einschlägige harmonisierte Normen zugrunde gelegt bzw. wird die Konformität erklärt in Bezug die nachfolgend genannten anderen technischen Spezifikationen:

The evaluation assessed the following applicable harmonised standards or the conformity is declared in relation to other technical specifications listed below:

L'évaluation est effectuée à partir des normes harmonisées applicable ou la conformité est déclarée en relation aux autres spécifications techniques désignées ci-dessous:

- EN 50581:2012

Diese Erklärung wird verantwortlich für den Hersteller:

This declaration is submitted on behalf of the manufacturer:

Le fabricant assume la responsabilité de cette déclaration:

NIVUS GmbH
Im Taele 2
75031 Eppingen
Allemagne

abgegeben durch / *represented by / faite par:*

Marcus Fischer (Geschäftsführer / *Managing Director / Directeur général*)

Eppingen, den 08.02.2018

Gez. *Marcus Fischer*

UK Declaration of Conformity

NIVUS GmbH
Im Tale 2
75031 Eppingen

Telefon: +49 07262 9191-0
Telefax: +49 07262 9191-999
E-Mail: info@nivas.com
Internet: www.nivas.de

For the following product:

Description:	Charging station NFM
Type:	NFM02 LADESCH

we declare under our sole responsibility that the equipment made available on the UK market as of the date of signature of this document meets the standards of the following applicable UK harmonisation legislation:

- SI 2012 / 3032 The Restriction of the Use of Certain Hazardous Substances in Electrical and Electronic Equipment Regulations 2012

The evaluation assessed the following applicable harmonised standards or the conformity is declared in relation to other technical specifications listed below:

- BS EN 50581:2012

This declaration is submitted on behalf of the manufacturer:

NIVUS GmbH
Im Taele 2
75031 Eppingen
Germany

represented by:

Ingrid Steppe (Managing Director)

Eppingen, 20/10/2022

Signed by *Ingrid Steppe*



Translation

(1) **EU-Type Examination Certificate**

- (2) Equipment and protective systems intended for use in potentially explosive atmospheres, **Directive 2014/34/EU**



(3) **Certificate Number** TÜV 17 ATEX 196722 X **issue:** 01

(4) for the product: Portable Measuring Transformer
NivuFlow Mobile Typ NFM-0xxx x E and
NivuLevel Mobile Typ NFM-0050 x E

(5) of the manufacturer: NIVUS GmbH

(6) Address: Im Täle 2
75031 Eppingen

Order number: 8003009451

Date of issue: 2019-10-28

- (7) The design of this product and any acceptable variation thereto are specified in the schedule to this EU-Type Examination Certificate and the documents therein referred to.

- (8) The TÜV NORD CERT GmbH, Notified Body No. 0044, in accordance with Article 17 of the Directive 2014/34/EU of the European Parliament and the Council of 26 February 2014, certifies that this product has been found to comply with the Essential Health and Safety Requirements relating to the design and construction of products intended for use in potentially explosive atmospheres given in Annex II to the Directive.
The examination and test results are recorded in the confidential ATEX Assessment Report No. 19 203 251874.

- (9) Compliance with the Essential Health and Safety Requirements has been assured by compliance with:

EN 60079-0:2012+A11:2013 EN 60079-11:2012 EN 60079-7:2015
EN 60079-18:2015

except in respect of those requirements listed at item 18 of the schedule.

- (10) If the sign "X" is placed after the certificate number, it indicates that the product is subject to the Specific Conditions for Use specified in the schedule to this certificate.

- (11) This EU-Type Examination Certificate relates only to the design, and construction of the specified product. Further requirements of the Directive apply to the manufacturing process and supply of this equipment. These are not covered by this certificate.

- (12) The marking of the product shall include the following:

 II 2 G Ex eb ib [ib] mb IIB T4 Gb

TÜV NORD CERT GmbH, Langemarckstraße 20, 45141 Essen, notified by the central office of the countries for safety engineering (ZLS), Ident. Nr. 0044, legal successor of the TÜV NORD CERT GmbH & Co. KG Ident. Nr. 0032

The head of the notified body



Rodér

Hanover office, Am TÜV 1, 30519 Hannover, Tel. +49 511 998-61455, Fax +49 511 998-61590

This certificate may only be reproduced without any change, schedule included.
Excerpts or changes shall be allowed by the TÜV NORD CERT GmbH



(13) **SCHEDULE**

(14) EU-Type Examination Certificate No. TÜV 17 ATEX 196722 X issue 01

(15) Description of product

Together with the belonging sensors, the Portable Measuring Transformer NivuFlow Mobile type NFM-0xxx x E and NivuLevel Mobile type NFM-0050 x E are used for the measurement of the flow speed and the flow level in partly or fully filled pipes and channels via supersonic technology. The Portable Measuring Transformer NivuFlow Mobile/NivuLevel Mobile type NFM... is operated stationary.

The permissible ambient temperature range is -15 °C ... +50 °C.

Electrical data

Supply voltage $U_n = 12 \text{ V d. c.}$
 (Internal plug connections) Powered with max. 2 x 12 V/15Ah VRLA-Pb-batteries;

External supply circuit in type of protection Intrinsic Safety Ex ib IIB
 (X1R [Uin], Only for connection to an intrinsically safe circuit
 X1B [GND]) Maximum values:
 $U_i = 14.5 \text{ V}$
 $I_i = 1.25 \text{ A}$
 $P_i = 18.1 \text{ W}$
 The effective internal capacitances and inductances are negligibly small.

1 wire circuit in type of protection Intrinsic Safety Ex ib IIB
 (CSM connector X10E [GND], Maximum values:
 X10F [1 wire];
 DSM connector X8E [GND], X8F [1 wire]) $U_o = 3.7 \text{ V}$
 $I_o = 57.3 \text{ mA}$
 $P_o = 53 \text{ mW}$
 Characteristic line: linear

Ex ib	IIB		
	max. permissible external inductance	65 mH	10 mH
max. permissible external capacitance	9.4 µF	21 µF	37 µF

5 V circuit in type of protection Intrinsic Safety Ex ib IIB
 (CSM connector X10E [GND], Maximum values:
 X10J [+5 V-Ex];
 DSM connector $U_o = 5.93 \text{ V}$
 X8E [GND], X8J [+5 V-Ex]) $I_o = 91.7 \text{ mA}$
 $P_o = 135.9 \text{ mW}$
 Characteristic line: linear

Ex ib	IIB		
	max. permissible external inductance	1 mH	0.2 mH
max. permissible external capacitance	14 µF	23 µF	30 µF



Schedule to EU-Type Examination Certificate No. TÜV 17 ATEX 196722 X issue 01

RS485 interface pressure, output in type of protection Intrinsic Safety Ex ib IIB
(CSM connector X10G [- RxTx], X10H [+ RxTx])

Maximum values:

$$U_o = 3.7 \text{ V}$$

$$I_o = 95.1 \text{ mA}$$

$$P_o = 88 \text{ mW}$$

Characteristic line: linear

Ex ib	IIB		
max. permissible external inductance	25 mH	10 mH	1 mH
max. permissible external capacitance	11 μ F	18 μ F	36 μ F

RS485 interface pressure, input in type of protection Intrinsic Safety Ex ib IIB
(CSM connector X10G [- RxTx], X10H [+ RxTx])

Only for connection to an intrinsically safe circuit

Maximum values:

$$U_i = 7.21 \text{ V}$$

$$I_i = 176 \text{ mA}$$

$$P_i = 317.2 \text{ mW}$$

The effective internal capacitances and inductances are negligibly small.

Radar sensor supply in type of protection Intrinsic Safety Ex ib IIB
(Connector X1A, X1B)

Maximum values:

$$U_o = 9.87 \text{ V}$$

$$I_o = 629 \text{ mA}$$

$$P_o = 6.21 \text{ W}$$

Characteristic line: rectangular

Ex ib	IIB		
max. permissible external inductance	0.2 mH	0.1 mH	0.05 mH
max. permissible external capacitance	5 μ F	8 μ F	11.9 μ F

RS485 interface, output in type of protection Intrinsic Safety Ex ib IIB
(Connector X1C, X1D)

Maximum values:

$$U_o = 3.7 \text{ V}$$

$$I_o = 95.1 \text{ mA}$$

$$P_o = 88 \text{ mW}$$

Characteristic line: linear

Ex ib	IIB		
max. permissible external inductance	25 mH	10 mH	1 mH
max. permissible external capacitance	11 μ F	18 μ F	36 μ F



Schedule to EU-Type Examination Certificate No. TÜV 17 ATEX 196722 X issue 01

RS485 interface, input in type of protection Intrinsic Safety Ex ib IIB
 (Connector X1C, X1D) Only for connection to an intrinsically safe circuit
 Maximum values:
 $U_i = 10.21 \text{ V}$
 $I_i = 248.8 \text{ mA}$
 $P_i = 633.8 \text{ mW}$
 The effective internal capacitances and inductances are negligibly small.

Analogue input no. 1 /2 in type of protection Intrinsic Safety Ex ib IIB
 (Connector X1G, X1F; X1H, X1J) Maximum values:
 NivuLevel Mobile type NFM-0050 x E: $U_o = 22.2 \text{ V}$
 Connector X7C, X7E; X7B, X7D) $I_o = 33 \text{ mA}$
 $R = 48 \text{ } \Omega$
 $P_o = 624 \text{ mW}$
 Characteristic line: trapezoidal

Ex ib	IIB		
max. permissible external inductance	20 mH	1 mH	0.1 mH
max. permissible external capacitance	0.52 μF	0.56 μF	1 μF

Analogue input no. 3 in type of protection Intrinsic Safety Ex ib IIB
 (Connector X1K, X1M) Maximum values:
 $U_o = 3.7 \text{ V}$
 $I_o = <1 \text{ mA}$
 $P_o = <1 \text{ mW}$
 Characteristic line: linear

Ex ib	IIB		
max. permissible external inductance	100 mH	10 mH	1 mH
max. permissible external capacitance	19 μF	24 μF	38 μF

Analogue input no. 3 in type of protection Intrinsic Safety Ex ib IIB
 (Connector X1K, X1M) Only for connection to an intrinsically safe circuit
 Maximum values:
 $U_i = 5.53 \text{ V}$
 $I_i = 33.5 \text{ mA}$
 $P_i = 185.4 \text{ mW}$
 The effective internal capacitances and inductances are negligibly small.



Schedule to EU-Type Examination Certificate No. TÜV 17 ATEX 196722 X issue 01

Analogue output in type of protection Intrinsic Safety Ex ib IIB
(Connector X1L, X1M)
Maximum values:
 $U_o = 15.78 \text{ V}$
 $I_o = 177.4 \text{ mA}$
 $P_o = 700 \text{ mW}$
Characteristic line: linear

Ex ib	IIB		
	max. permissible external inductance	5.5 mH	1 mH
max. permissible external capacitance	1 μF	2.4 μF	2.6 μF

Digital input in type of protection Intrinsic Safety Ex ib IIB
(Connector X1N, X1P)
Maximum values:
 $U_o = 3.7 \text{ V}$
 $I_o = < 1 \text{ mA}$
 $P_o = < 1 \text{ mW}$
Characteristic line: linear

Ex ib	IIB		
	max. permissible external inductance	100 mH	1 mH
max. permissible external capacitance	19 μF	38 μF	81 μF

Digital input in type of protection Intrinsic Safety Ex ib IIB
(Connector X1N, X1P)
Only for connection to an intrinsically safe circuit
Maximum values:
 $U_i = 19.69 \text{ V}$
 $I_i = 4.23 \text{ mA}$
 $P_i = 83.3 \text{ mW}$
The effective internal capacitances and inductances are negligibly small.

Piezo circuits in type of protection Intrinsic Safety Ex ib IIB
(CSM connector X10 A/B and C/D,
DSM connector X8 A/B and C/D)
Only for connection
to the belonging sensors of the manufacturer
Max. output energy: 146 μJ

Relay output in type of protection Intrinsic Safety Ex ib IIB
(Connector X1S, X1T, X1U)
Only for connection to an intrinsically safe circuit
Maximum values:
 $U_i = 26 \text{ V}$
 $I_i = 100 \text{ mA}$
 $P_i = 2.6 \text{ W}$
The effective internal capacitances and inductances are negligibly small.



Schedule to EU-Type Examination Certificate No. TÜV 17 ATEX 196722 X issue 01

SIM-card circuit in type of protection Intrinsic Safety Ex ib IIB
 (SIM-CARD connector) Maximum values:
 $U_o = 4.5 \text{ V}$
 $I_o = 283 \text{ mA}$
 $P_o = 319 \text{ mW}$
 Characteristic line: linear

Ex ib	IIB		
	max. permissible external inductance	1 mH	0.1 mH
max. permissible external capacitance	21 μF	51 μF	120 μF

The rules for interconnection of intrinsically safe circuits have to be observed.

(16) Drawings and documents are listed in the ATEX Assessment Report No. 19 203 251874.

(17) Specific Conditions for Use

1. Electrostatic charge has to be avoided for all housing parts and the interlock; the manual of the manufacturer has to be observed.
2. Charging of the supply batteries is only permitted outside of the explosion hazardous area with the charger of the manufacturer or with a separately certified charger (intrinsically safe charge circuit); the manual of the manufacturer has to be observed.
3. Change of the supply batteries / backup battery is only permitted outside of the explosion hazardous area.
4. Only permissible batteries according to the manufacturer's operating instructions are allowed to be used.
5. The memory stick is only permitted to be used outside of the explosion hazardous area at the USB port.
6. The change of the SIM card is only permitted outside of the explosion hazardous area. See "Electrical data" for operation in the explosion hazardous area.
7. Operation is only allowed in vertical position (plug-connectors downwards).
8. The housing has to be additionally secured by an interlock provided by the manufacturer.
9. The battery in the right-hand housing part (connections MP1/MP2) is not allowed to be connected, if the external power supply is used.
10. The connections at X8 are only permissible for use of the manufacturer for firmware-updates in the safe area.



(18) Essential Health and Safety Requirements

no additional ones

- End of Certificate -

		<h2 style="margin: 0;">IECEX Certificate of Conformity</h2>	
<p>INTERNATIONAL ELECTROTECHNICAL COMMISSION IEC Certification System for Explosive Atmospheres <small>for rules and details of the IECEx Scheme visit www.iecex.com</small></p>			
Certificate No.:	IECEX TUN 18.0008X	Page 1 of 4	Certificate history: Issue 0 (2018-07-27)
Status:	Current	Issue No: 1	
Date of Issue:	2019-11-13		
Applicant:	NIVUS GmbH Im Talle 2, 75031 Eppingen Germany		
Equipment:	Portable Measuring Transformer NivuFlow Mobile type NFM-0xxx x E, NivuLevel Mobile type NFM-0050 x E		
Optional accessory:			
Type of Protection:	Increased safety "e", intrinsic safety "i", encapsulation "m"		
Marking:	Ex eb ib [Ib] mb IIB T4 Gb		
Approved for issue on behalf of the IECEx Certification Body:		Christian Roder	
Position:		Head of the IECEx Certification Body	
Signature: (for printed version)		 <hr/>	
Date:		 <hr/>	
<ol style="list-style-type: none"> 1. This certificate and schedule may only be reproduced in full. 2. This certificate is not transferable and remains the property of the issuing body. 3. The Status and authenticity of this certificate may be verified by visiting www.iecex.com or use of this QR Code. 			
Certificate issued by:			
TÜV NORD CERT GmbH Hanover Office Am TÜV 1, 30519 Hannover Germany			

		<h2>IECEX Certificate of Conformity</h2>	
Certificate No.:	IECEX TUN 18.0008X	Page 2 of 4	
Date of issue:	2019-11-13	Issue No: 1	
Manufacturer:	NIVUS GmbH Im Tale 2, 75031 Eppingen Germany		
Additional manufacturing locations:			
This certificate is issued as verification that a sample(s), representative of production, was assessed and tested and found to comply with the IEC Standard list below and that the manufacturer's quality system, relating to the Ex products covered by this certificate, was assessed and found to comply with the IECEx Quality system requirements. This certificate is granted subject to the conditions as set out in IECEx Scheme Rules, IECEx 02 and Operational Documents as amended			
STANDARDS : The equipment and any acceptable variations to it specified in the schedule of this certificate and the identified documents, was found to comply with the following standards			
IEC 60079-0:2011	Explosive atmospheres - Part 0: General requirements		
Edition:6.0			
IEC 60079-11:2011	Explosive atmospheres - Part 11: Equipment protection by intrinsic safety "i"		
Edition:6.0			
IEC 60079-18:2014	Explosive atmospheres – Part 18: Equipment protection by encapsulation "m"		
Edition:4.0			
IEC 60079-7:2015	Explosive atmospheres – Part 7: Equipment protection by increased safety "e"		
Edition:5.0			
This Certificate does not indicate compliance with safety and performance requirements other than those expressly included in the Standards listed above.			
TEST & ASSESSMENT REPORTS: A sample(s) of the equipment listed has successfully met the examination and test requirements as recorded in:			
Test Report:			
	DE/TUN/EXTR18.0013/00		
Quality Assessment Report:			
	DE/TUN/QAR13.0011/06		

		IECEX Certificate of Conformity
Certificate No.:	IECEX TUN 18.0008X	Page 3 of 4
Date of issue:	2019-11-13	Issue No: 1
EQUIPMENT: Equipment and systems covered by this Certificate are as follows:		
Together with the belonging sensors, the "Portable Measuring Transformer"		
NivuFlow Mobile type NFM-0xxx x E and		
NivuLevel Mobile type NFM-0050 x E		
are used for the measurement of the flow speed and the flow level in partly or fully filled pipes and channels via supersonic technology.		
The Portable Measuring Transformer type NivuFlow Mobile NFM is operated stationary.		
The permissible ambient temperature range is -15 °C ... +50 °C.		
For further information, see attachment.		
SPECIFIC CONDITIONS OF USE: YES as shown below:		
<ol style="list-style-type: none">1. Electrostatic charge has to be avoided for all housing parts and the interlock; the manual of the manufacturer has to be observed.2. Charging of the supply batteries is only permitted outside of the explosion hazardous area with the charger of the manufacturer or with a separately certified charger (Intrinsically safe charge circuit); the manual of the manufacturer has to be observed.3. Change of the supply batteries / backup battery is only permitted outside of the explosion hazardous area.4. Only permissible batteries according to the manufacturer's operating instructions are allowed to be used.5. The memory stick is only permitted to be used outside of the explosion hazardous area at the USB port.6. The change of the SIM card is only permitted outside of the explosion hazardous area. See "Electrical data" for operation in the explosion hazardous area.7. Operation is only allowed in vertical position (plug-connectors downwards).8. The housing has to be additionally secured by an interlock provided by the manufacturer.9. The battery in the right-hand housing part (connections MP1/MP2) is not allowed to be connected, if the external power supply is used.10. The connections at X8 are only permissible for use of the manufacturer for firmware-updates in the safe area.		

	IECEX Certificate of Conformity
Certificate No.: IECEX TUN 18.0008X	Page 4 of 4
Date of issue: 2019-11-13	Issue No: 1
DETAILS OF CERTIFICATE CHANGES (for issues 1 and above)	
-Mechanical changes	
-Layout changes	
-Electrical data partly changed	
-Special Conditions partly changed	
-New type with less components "NivuLevel Mobile type NFM-0050 x E"	
Annex:	
Attachment _issue 1_NivuFlow Mobile.pdf	

TÜV NORD CERT GmbH
Hannover Office
Am TÜV 1
30519 Hannover
Germany



Page 1 of 5
Attachment to IECEx TUN 18.0008 X issue No.: 01

Product:

Together with the belonging sensors, the Portable Measuring Transformer NivuFlow Mobile type NFM-0xxx x E and NivuLevel Mobile type NFM-0050 x E are used for the measurement of the flow speed and the flow level in partly or fully filled pipes and channels via supersonic technology. The Portable Measuring Transformer NivuFlow Mobile/NivuLevel Mobile type NFM... is operated stationary.

The permissible ambient temperature range is -15 °C ... +50 °C.

Electrical data

Supply voltage $U_n = 12 \text{ V d. c.}$
(Internal plug connections) Powered with max. 2 x 12 V/15Ah VRLA-Pb-batteries:

External supply circuit in type of protection Intrinsic Safety Ex ib IIB
(X1R [Uin], Only for connection to an intrinsically safe circuit
X1B [GND]) Maximum values:
 $U_i = 14.5 \text{ V}$
 $I_i = 1.25 \text{ A}$
 $P_i = 18.1 \text{ W}$
The effective internal capacitances and inductances are negligibly small.

1 wire circuit in type of protection Intrinsic Safety Ex ib IIB
(CSM connector X10E [GND], Maximum values:
X10F [1 wire];
DSM connector X8E [GND], X8F [1 wire]) $U_o = 3.7 \text{ V}$
 $I_o = 57.3 \text{ mA}$
 $P_o = 53 \text{ mW}$
Characteristic line: linear

	Ex ib		IIB	
	max. permissible external inductance	65 mH	10 mH	1 mH
max. permissible external capacitance	9.4 μF	21 μF	37 μF	

5 V circuit in type of protection Intrinsic Safety Ex ib IIB
(CSM connector X10E [GND], Maximum values:
X10J [+5 V-Ex];
DSM connector $U_o = 5.93 \text{ V}$
X8E [GND], X8J [+5 V-Ex]) $I_o = 91.7 \text{ mA}$
 $P_o = 135.9 \text{ mW}$
Characteristic line: linear

	Ex ib		IIB	
	max. permissible external inductance	1 mH	0.2 mH	0.1 mH
max. permissible external capacitance	14 μF	23 μF	30 μF	

TÜV NORD CERT GmbH
 Hannover Office
 Am TÜV 1
 30519 Hannover
 Germany



Page 2 of 5
 Attachment to IECEx TUN 18.0008 X issue No.: 01

RS485 interface pressure, output in type of protection Intrinsic Safety Ex ib IIB
 (CSM connector X10G [- RxTx], X10H [+ RxTx]) Maximum values:

$U_o = 3.7 \text{ V}$
 $I_o = 95.1 \text{ mA}$
 $P_o = 88 \text{ mW}$
 Characteristic line: linear

Ex ib	IIB		
max. permissible external inductance	25 mH	10 mH	1 mH
max. permissible external capacitance	11 μF	18 μF	36 μF

RS485 interface pressure, input in type of protection Intrinsic Safety Ex ib IIB
 (CSM connector X10G [- RxTx], X10H [+ RxTx]) Only for connection to an intrinsically safe circuit
 Maximum values:

$U_i = 7.21 \text{ V}$
 $I_i = 176 \text{ mA}$
 $P_i = 317.2 \text{ mW}$
 The effective internal capacitances and inductances are negligibly small.

Radar sensor supply in type of protection Intrinsic Safety Ex ib IIB
 (Connector X1A, X1B) Maximum values:

$U_o = 9.87 \text{ V}$
 $I_o = 629 \text{ mA}$
 $P_o = 6.21 \text{ W}$
 Characteristic line: rectangular

Ex ib	IIB		
max. permissible external inductance	0.2 mH	0.1 mH	0.05 mH
max. permissible external capacitance	5 μF	8 μF	11.9 μF

RS485 interface, output in type of protection Intrinsic Safety Ex ib IIB
 (Connector X1C, X1D) Maximum values:

$U_o = 3.7 \text{ V}$
 $I_o = 95.1 \text{ mA}$
 $P_o = 88 \text{ mW}$
 Characteristic line: linear

Ex ib	IIB		
max. permissible external inductance	25 mH	10 mH	1 mH
max. permissible external capacitance	11 μF	18 μF	36 μF

TÜV NORD CERT GmbH
Hannover Office
Am TÜV 1
30519 Hannover
Germany



Page 3 of 5
Attachment to IECEx TUN 18.0008 X Issue No.: 01

RS485 interface, input in type of protection Intrinsic Safety Ex ib IIB
(Connector X1C, X1D) Only for connection to an intrinsically safe circuit
Maximum values:
 $U_i = 10.21 \text{ V}$
 $I_i = 248.8 \text{ mA}$
 $P_i = 633.8 \text{ mW}$
The effective internal capacitances and inductances are negligibly small.

Analogue input no. 1 /2 in type of protection Intrinsic Safety Ex ib IIB
(Connector X1G, X1F; X1H, X1J) Maximum values:
NivuLevel Mobile type NFM-0050 x E: $U_o = 22.2 \text{ V}$
Connector X7C, X7E; X7B, X7D) $I_o = 33 \text{ mA}$
 $R = 48 \text{ } \Omega$
 $P_o = 624 \text{ mW}$
Characteristic line: trapezoidal

	Ex ib	IIB	
max. permissible external inductance	20 mH	1 mH	0.1 mH
max. permissible external capacitance	0.52 μF	0.56 μF	1 μF

Analogue input no. 3 in type of protection Intrinsic Safety Ex ib IIB
(Connector X1K, X1M) Maximum values:
 $U_o = 3.7 \text{ V}$
 $I_o = <1 \text{ mA}$
 $P_o = <1 \text{ mW}$
Characteristic line: linear

	Ex ib	IIB	
max. permissible external inductance	100 mH	10 mH	1 mH
max. permissible external capacitance	19 μF	24 μF	38 μF

Analogue input no. 3 in type of protection Intrinsic Safety Ex ib IIB
(Connector X1K, X1M) Only for connection to an intrinsically safe circuit
Maximum values:
 $U_i = 5.53 \text{ V}$
 $I_i = 33.5 \text{ mA}$
 $P_i = 185.4 \text{ mW}$
The effective internal capacitances and inductances are negligibly small.

TÜV NORD CERT GmbH
 Hannover Office
 Am TÜV 1
 30519 Hannover
 Germany



Page 4 of 5
 Attachment to IECEx TUN 18.0008 X issue No.: 01

Analogue output (Connector X1L, X1M)	in type of protection Intrinsic Safety Ex ib IIB Maximum values: $U_o = 15.78 \text{ V}$ $I_o = 177.4 \text{ mA}$ $P_o = 700 \text{ mW}$ Characteristic line: linear												
	<table border="1"> <thead> <tr> <th>Ex ib</th> <th colspan="3">IIB</th> </tr> </thead> <tbody> <tr> <td>max. permissible external inductance</td> <td>5.5 mH</td> <td>1 mH</td> <td>0.1 mH</td> </tr> <tr> <td>max. permissible external capacitance</td> <td>1 μF</td> <td>2.4 μF</td> <td>2.6 μF</td> </tr> </tbody> </table>	Ex ib	IIB			max. permissible external inductance	5.5 mH	1 mH	0.1 mH	max. permissible external capacitance	1 μF	2.4 μF	2.6 μF
Ex ib	IIB												
max. permissible external inductance	5.5 mH	1 mH	0.1 mH										
max. permissible external capacitance	1 μF	2.4 μF	2.6 μF										
Digital input (Connector X1N, X1P)	in type of protection Intrinsic Safety Ex ib IIB Maximum values: $U_o = 3.7 \text{ V}$ $I_o = < 1 \text{ mA}$ $P_o = < 1 \text{ mW}$ Characteristic line: linear												
	<table border="1"> <thead> <tr> <th>Ex ib</th> <th colspan="3">IIB</th> </tr> </thead> <tbody> <tr> <td>max. permissible external inductance</td> <td>100 mH</td> <td>1 mH</td> <td>0.1 mH</td> </tr> <tr> <td>max. permissible external capacitance</td> <td>19 μF</td> <td>38 μF</td> <td>81 μF</td> </tr> </tbody> </table>	Ex ib	IIB			max. permissible external inductance	100 mH	1 mH	0.1 mH	max. permissible external capacitance	19 μF	38 μF	81 μF
Ex ib	IIB												
max. permissible external inductance	100 mH	1 mH	0.1 mH										
max. permissible external capacitance	19 μF	38 μF	81 μF										
Digital input (Connector X1N, X1P)	in type of protection Intrinsic Safety Ex ib IIB Only for connection to an intrinsically safe circuit Maximum values: $U_i = 19.69 \text{ V}$ $I_i = 4.23 \text{ mA}$ $P_i = 83.3 \text{ mW}$ The effective internal capacitances and inductances are negligibly small.												
Piezo circuits (CSM connector X10 A/B and C/D, DSM connector X8 A/B and C/D)	in type of protection Intrinsic Safety Ex ib IIB Only for connection to the belonging sensors of the manufacturer Max. output energy: 146 μJ												
Relay output (Connector X1S, X1T, X1U)	in type of protection Intrinsic Safety Ex ib IIB Only for connection to an intrinsically safe circuit Maximum values: $U_i = 26 \text{ V}$ $I_i = 100 \text{ mA}$ $P_i = 2.6 \text{ W}$ The effective internal capacitances and inductances are negligibly small.												

TÜV NORD CERT GmbH
Hannover Office
Am TÜV 1
30519 Hannover
Germany



Page 5 of 5
Attachment to IECEx TUN 18.0008 X Issue No.: 01

SIM-card circuit in type of protection Intrinsic Safety Ex ib IIB
(SIM-CARD connector)
Maximum values:
 $U_o = 4.5 \text{ V}$
 $I_o = 283 \text{ mA}$
 $P_o = 319 \text{ mW}$
Characteristic line; linear

	IIB		
	Ex ib	0.1 mH	0.02 mH
max. permissible external inductance	1 mH	0.1 mH	0.02 mH
max. permissible external capacitance	21 μF	51 μF	120 μF

The rules for interconnection of intrinsically safe circuits have to be observed.

Special Conditions for Safe Use:

1. Electrostatic charge has to be avoided for all housing parts and the interlock; the manual of the manufacturer has to be observed.
2. Charging of the supply batteries is only permitted outside of the explosion hazardous area with the charger of the manufacturer or with a separately certified charger (intrinsically safe charge circuit); the manual of the manufacturer has to be observed.
3. Change of the supply batteries / backup battery is only permitted outside of the explosion hazardous area.
4. Only permissible batteries according to the manufacturer's operating instructions are allowed to be used.
5. The memory stick is only permitted to be used outside of the explosion hazardous area at the USB port.
6. The change of the SIM card is only permitted outside of the explosion hazardous area. See "Electrical data" for operation in the explosion hazardous area.
7. Operation is only allowed in vertical position (plug-connectors downwards).
8. The housing has to be additionally secured by an interlock provided by the manufacturer.
9. The battery in the right-hand housing part (connections MP1/MP2) is not allowed to be connected, if the external power supply is used.
10. The connections at X8 are only permissible for use of the manufacturer for firmware-updates in the safe area.